

# RA3100

## Omniace

### Simple Instruction Manual



A&D Company, Ltd.

## CAUTION

- (1) Turn off the power when the operation is abnormal.  
If it is impossible to trace the causes of an abnormal operation, please contact our sales representative.
- (2) The contents of this manual are subject to change without notice.
- (3) This manual is copyrighted with all rights reserved. This manual may not be reproduced, modified, or translated without the written permission of A&D Company, Limited. No parts of this manual may be transcribed without permission.
- (4) Please let us know if there are any points that are unclear or missing in this manual.
- (5) A&D Company, Limited. will not be held responsible for any damages or loss of income caused by the operation of this device or any direct, indirect, special, or inevitable damages caused by defects in the product, even if there is notice that the corresponding damages may occur. We will also not be held responsible for any third party claims of rights. At the same time, we will not be held responsible for any loss of data. We will not be held responsible for any of such points as those indicated in item (4).

© 2020 A&D Company, Limited.

- Omniace is a registered trademark of A&D Company, Limited.
- Microsoft and Windows 10 IoT are trademarks or registered trademarks of Microsoft Corporation in the United States and other countries.
- Software owned by Adobe Corporation in the United States is used based on the SIL Open Font License.

## Introduction

We thank you for your purchase of our data acquisition product OMNIACE RA3100 (hereinafter "the RA3100" or "this product").

This instruction manual explains cautions and basic methods for handling the RA3100.

Please read this manual before operating this instrument. For information on other handling, please read the following instruction manual contained on the included CD.

If you encounter any problems in the manual, please contact our company.

### <Instruction manual on CD>

Manual	Contents
RA3100 Instruction Manual	Explains how to handle and configure the RA3100.

## Examining Contents in Package

### When Opening Package

When opening the package in a warm room during the cold season, open the package after it has reached room temperature to avoid any operational failure due to condensation on the surface of the product.

### Examining Contents in Package

This instrument is delivered after a thorough examination at the factory prior to shipment. However, please examine the product's condition and verify that no obvious shipping damage has occurred after opening the package. Also, examine the specifications of the input units and accessories. If there are any missing or damaged items, please contact our sales representative.

### <Contents in Package>

Name	Model/document number	Quantity	Remarks
Omniace main unit	RA3100	1	AC 100 V to 240 V
Simple Operation Manual	1WMPD4004445B	1	This manual is described cautions on use and operations methods.
Instruction Manual CD-ROM	1WMEK4010464	1	Includes the RA3100 Instruction Manual
AC power cable	-		The cable selected at ordering the product.
Thermal recording paper	YPS-106	1 roll	30 m roll recording paper (5 rolls per box)
Recording paper holder	5633-1794	2	Recording paper both edges x 1 each



\* Plug types use standard domestic nomenclature. The IEC category is indicated in parentheses.

# To Safely Use Products



## Safety Measures - Warnings and Cautions

- This product is designed and tested to conform to the EN61010 standard.
- The product is manufactured with safety in mind. However, accidents may occur due to misuse by the user. To avoid such accidents, read this manual carefully before use. Observe the following warning and cautions when using the product. The following statements are used in this manual to call the readers' attention.
- Be sure to observe the following instructions when using this product. The warranty does not cover damages resulting from the actions against instructions, cautions, or warnings mentioned in this manual. Besides, there are a lot of actions that are "cannot" and "do not". It is impossible to write all such descriptions in this manual. Accordingly, assume any actions to be "impossible" except the actions explicitly described as "possible".

## Meaning of Warning Signs

 <b>WARNING</b>	This indicates a condition or practice that could result in personal injury or loss of life, or may result in light injury or physical damage if this equipment is misused due to neglect of a Warning.
 <b>CAUTION</b>	This indicates a condition or practice that could result in light injury or damage to the equipment or other property if this equipment is misused due to neglect of a Caution.

## Meaning of Symbols

	<p>△ symbols indicate cautions (including warnings). Specific precautions are indicated inside figures (in the example on the left, a warning about electrocution).</p>
	<p>⊘ symbols indicate prohibited actions. Specific prohibited actions are indicated inside ⊘ or with nearby text or pictures. The example on the left indicates that disassembly is prohibited.</p>
	<p>● symbols indicate actions that must be taken. Specific actions that must be taken are indicated inside ● or with nearby text or pictures. The example on the left indicates an action that must be taken.</p>

⚠ <b>WARNING</b>
<p><b>Power</b></p> <p>□ Make sure that the power supply is within the rating indicated on the rating plate attached to this product.</p> <p>If any voltage exceeding the rated voltage was supplied, there would be risk of damage to this product, or even a fire. Also, in order to prevent electric shock and hazards such as a fire, be sure to use only the AC power cable supplied with this product.</p>

 **WARNING****Protective Grounding**

- Be sure to ground this product before supplying power. Grounding is necessary to use this product safely, as well as to protect the user and peripheral equipment from injury or damage. Be sure to observe the following instructions.
- The AC power cable included with this product contains a ground lead. Connect the power cable into only a 3-pin AC outlet with a ground pole.
- When grounding, do not connect the grounding lead to a water pipe, as water pipes are not necessarily conductive to the earth. Never connect the ground lead to a gas pipe either, as it is extremely dangerous.
- While the power is supplied to the product, do not cut or remove the protective grounding line. Otherwise, safety of the product is not guaranteed.

**Overvoltage Category (Installation Category)**

- This product's Overvoltage Category is Category II. Do not use the product with higher categories, as connecting it to the line of a distribution board, etc. (CAT III) or the lead-in wire of a main power line (CAT IV) may lead to device failure.

**Measurement Category**

- The measurement input terminal Measurement Category of this product differs according to the installed modules.  
Use the product for measurement within the Measurement Category that meets the module specifications. Do not use it with a Measurement Category that exceeds the module specifications.

**Connection of Input Signals**

- Be sure to ground the grounding terminal of this product before connecting to the measurement target. Also, when connecting this product to another measurement instrument, be careful not to exceed the maximum allowable common mode input voltage range.  
A voltage exceeding the range can cause damage to this product.

**Use in Gaseous Atmosphere**

- Never use this product in a flammable or explosive atmosphere, or an atmosphere containing steam. Use in such atmosphere will result in danger to users and the product.

**Disassembling the Frame**

- It is dangerous to remove the frame of this product due to the high-voltage parts inside. The frame must not be removed from the product other than by our service engineers.

**Fuse at AC Power Supply Block**

- The fuse for this product cannot be replaced by the customer because it is located inside the main unit. Please contact our sales representative if the fuse may be blown.

**Handling of Back-up Battery (Cautions when Disposing)**

- This product includes a coin-type lithium battery (primary cell).  
When disposing of this product, remove the battery in advance.  
Do not dispose of the battery in fire or disassemble. The battery may explode when it is heated and organic electrolyte that may exude from it is harmful to human skin. When disposing of the battery, isolate the terminals by covering with tape and dispose the battery as a dangerous article.

## CAUTION

### Caution in Handling

When using this product, always follow the precautions below. Improper handling may lead to erroneous operations and damages.

- Users who are not familiar with the operation of this product should avoid using it.
- Use this product at locations that satisfy the overvoltage requirement, the Category II (CAT II) of the safety standard for electrical measurement instruments in EN61010-1.
- This product has a Pollution Degree of 2.
- This product is a Class A product for industrial environments.  
Use in household environments may cause electromagnetic interference. In such cases, the user must implement appropriate countermeasures.
- Store this product in the following storage environments. Avoid storing in places where the temperature could rise over the storage temperature and where there is direct sunlight exposure such as inside an automobile.  
Storage temperature range: -20 to 60°C      Storage humidity range: 20 to 85% RH (without condensation)
- Use this product in the following operating environments.  
Operating temperature range: 0 to 40°C      Operating humidity range: 35 to 85% RH (without condensation)
- Do not use this product at the following locations. In addition, carefully check the environment when using this product.
  - Locations where the temperature and humidity rise due to direct sunlight or heaters
  - Wet locations
  - Locations where salt, oil, or corrosive gases exist
  - Dusty locations
  - Locations subject to strong vibrations
  - Locations with a strong electromagnetic field
  - This product is provided with ventilation openings in order to prevent overheating. Ensure that the ventilation openings remain unobstructed by covers or materials. Otherwise, the internal temperature of the product rises, causing malfunctions.
  - Do not place highly combustible objects such as paper near the product.
- Be careful of power voltage fluctuations. Do not use the product when these are likely to exceed the rated voltage.
- If the power supply includes a lot of noise or high-voltage inductive noise, use noise filters to avoid operation errors.
- A solid-state drive is installed in this product.  
Please don't power off during normal operation of the SSD (while data is being saved/read), due to the risk of data destruction.

 **CAUTION**

- This product uses an electrostatic capacitive touch panel.  
Press the touch panel gently with your bare fingertip. The touch screen may not react if you are wearing gloves. Also do not use a sharp object or push with higher pressure than necessary. Pressing three or more locations at once may cause misoperations. Be sure to press only one location when making a selection or two locations with pinching in/pinching out.
- LCD display  
This product has a TFT color LCD for display. There may be cases where the light of pixels does not come on or off in the LCD. In addition, the LCD includes unevenness slightly due to temperature changes. Please be aware that these cases are not disorders.
- Use the chart recording paper specified by A&D. Use of a chart that is not recommended may cause failure in printing or shorten the life of the thermal head.
- Recording straight line waveforms or waveforms in solid black in the same position for an extended period of time may shorten the life of the elements in that part of the thermal head. It is recommended that the waveform recording position is occasionally changed.
- Printing a waveform in solid black for an extended period of time causes printing waste of the recording paper to remain in the thermal head, and may prevent printing. Periodically clean the thermal head.
- When storing the product for an extended period of time, the recording paper feeding platen may become deformed if the printer cover is locked and cause printing irregularities, but this does not indicate product failure.
- When storing recording paper for an extended period of time before recording, remove the recording paper from the main unit and insert it in a plastic bag, or as-is if it is still in its original packaging, and then store it in a dark location with a temperature of 25°C or less and humidity of 70% RH or less.
- When storing recording paper for an extended period of time after recording, file it in a dark location with a temperature of 25°C or less and humidity of 70% RH or less. When using a file folder, make sure that it is made of a material that does not include plasticizer (such as polyethylene or polypropylene).
- If the recording paper touches the following materials or products, the printing surface may change color, lose color, or exhibit otherwise poor color performance.  
Vinyl chloride products, organic compounds, adhesive tape, pencil eraser, rubber mats, magic markers, felt-tip pens, correction fluid, carbon, diazo photosensitive paper, hand cream, hairdressing products, cosmetic products, or leather products such as a wallet
- Do not insert a pointed or sharp object into the ventilation openings of this product.
- To clean this product, first turn off the power, place it in a well-ventilated location, and wipe the product using soft cloth moistened with ethanol. Do not use benzene, petroleum solvents, or chemically treated cloths, as they can cause deformation or discoloration.
- When transporting the product, use the package and packaging material supplied at factory shipment, or use a package and packaging material more shock-resistant than those supplied.
- We recommend a periodical calibration to maintain the accuracy of the input units. More reliable measurements are possible by calibrating the input units once a year (extra cost option).

## CAUTION

### Windows 10 IoT

This product adopts Windows 10 IoT as its operating system. Please read and understand the following instructions carefully before use.

License

The Windows 10 IoT operating system used in this product is provided with a license for embedded use only.

This product cannot function as a general purpose PC, and it is limited exclusively for RA3100 use.

The embedded system of this product is not allowed to be duplicated and used.

Power on/off

This product enters the standby state when the AC power cable is connected, where it consumes a tiny amount of standby power. When the **Power** key on the panel is pressed, the main power starts and the product enters the monitoring state.

When turning off the power, confirm that the internal SSD of the product is not being accessed.

When the **Power** key is pressed, the [Shut down] screen is displayed. Tap **Yes** to shut down the product. Directly removing the power cable to turn off the power may damage the data on the SSD and make the SSD unable to be used.

When the product will not be used for an extended period of time, remove the power cable after the shut down process is complete.

Use on a Network

Please consult your network administrator to make sure that other tasks are not affected by connecting this product to the network.

Computer Viruses

This product does not include any virus search or removal software other than the standard Windows functions, in order to ensure it maintains adequate performance. Take care when connecting the product to a network or external media.

Other

We do not assume any responsibility or provide support for malfunctions if programs that are not provided by us are installed into the system, the operating system settings are changed, or programs are forcibly terminated via an input device such as a keyboard or mouse.

## Disposing of the Used Product

### In the European Union

EU-wide legislation as implemented in each Member State requires that used electrical and electronic products carrying the mark (right) must be disposed of separately from normal household waste. This includes electrical accessories, such as chargers or AC adapters.

The mark on the electrical and electronic products only applies to the current European Union Member States.















### Outside the European Union

If you wish to dispose of used electrical and electronic products outside the European Union, please contact your local authority and ask for the correct method of disposal.



## Symbols in This Manual

Terms and symbols used in this manual denote as follows.

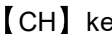
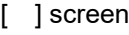
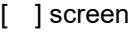
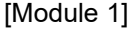
 <b>WARNING</b>	This indicates a condition or practice that could result in personal injury or loss of life, or may result in light injury or physical damage if this equipment is misused due to neglect of a Warning.
 <b>CAUTION</b>	This indicates a condition or practice that could result in light injury or damage to the equipment or other property if this equipment is misused due to neglect of a Caution.
 <b>NOTE</b>	This indicates a condition or practice that could result in incorrect operation or damage to data if this equipment is misused due to neglect of a Note, as well as measurement limitations and additional explanations.
	Reference page
	A tap is the act of lightly touching an item such as a key displayed on the screen with a finger. Example Used for selecting or setting screen keys.
	A swipe is the act of pressing the screen with a finger and moving it in a specific direction. Example Used on screens such as the [Thumbnail] screen and [Channel Settings] screen.
	A pinch in is the act of touching the screen with two fingers and moving those fingers closer to each other, and reduces the screen. Example Used to reduce the content displayed on the screen, waveform amplitude, or time axis, etc.
	A pinch out is the act of touching the screen with two fingers and moving those fingers apart from each other, and enlarges the screen. Example Used to enlarge the content displayed on the screen, waveform amplitude, or time axis, etc.
 key	Enclosed characters represent a key name on the operation panel. Example  key
 key	Text enclosed in  indicates touch panel keys displayed on the screen. Example  key
 screen	Text enclosed in  indicates the text of items on the screen. Example 
k (lower case) K (upper case)	Example 1 kg = 1000 g 1 KB = 1024 bytes

# Warranty

## Warranty - General

We ship our products after conducting quality control, which covers from design to manufacturing. It is, however, possible that failures may occur in the products. If the product does not operate correctly, please make a check of the power supply, cable connections, or other conditions before returning this product to us.

For repair or calibration, contact our sales agency. Before returning, be sure to inform us of the model (RA3100), serial number, and problematic points.

The following is our warranty.

## Limited Warranty

1. Warranty period: One year from our shipment.
2. Warranty scope: The warranty only covers the main unit of the product.  
We will repair the defects of our product free of charge within the warranty period; however, this warranty does not apply in the following cases.
  - Damage or faults caused by incorrect use
  - Damage or faults caused by fire, earthquake, traffic accident, or other natural disasters
  - Damage or faults caused by a repair or modification that is carried out by someone other than a service representative of A&D
  - Damage or faults caused by use or storage in environmental conditions that should be avoided
  - Periodical calibration
  - Damage or faults caused during transportation.
  - The thermal printing head may not be covered by the warranty even within the warranty period, depending on the usage conditions.  
Usage conditions: 30 million printing pulses or more or recording length 30 km or longer
  - The internal SSD, fan, and backup coin-type battery are treated as consumables and not covered by the warranty.
  - Data recorded on the SSD and external media is not covered by the warranty, regardless of the cause and type of product failure. Make sure to back up your recorded data.
3. Liability: We do not assume any liability for equipment other than A&D equipment.

---



---

# CONTENTS

INTRODUCTION .....	3
EXAMINING CONTENTS IN PACKAGE .....	3
TO SAFELY USE PRODUCTS .....	4
DISPOSING OF THE USED PRODUCT .....	8
SYMBOLS IN THIS MANUAL .....	9
WARRANTY .....	10
1. NAME AND FUNCTION OF EACH BLOCK .....	13
1.1. Name of Each Block .....	13
1.2. Display Block .....	14
1.3. Operation Panel .....	15
1.4. Input Module Block .....	16
1.5. Screen and Setup Menu .....	16
1.5.1. Side menu .....	17
1.5.2. Control Bar .....	18
2. PRE-MEASUREMENT PROCEDURES .....	20
2.1. Before Switching On the Power .....	20
2.1.1. Installation and Usage Environment .....	20
2.1.2. Installing Input Modules .....	21
2.1.3. Paper Loading .....	22
2.2. Turning the Power On/Off .....	24
2.2.1. Connecting the AC Power Cable .....	24
2.2.2. Turning On the Power .....	24
2.2.3. Confirming Normal Startup .....	25
2.2.4. Preparing for More Precise Measurements .....	25
2.2.5. Turning Off the Power .....	25
3. FLOW OF MEASUREMENT .....	26
3.1. Flow of Measurement .....	26
4. CONFIGURING MEASUREMENT .....	27
4.1. Reducing the Input Sensitivity and Connecting the Input Cable .....	27
4.2. Setup the Input Channel .....	29
4.2.1. Channel Setup sub menu (For RA30-101) .....	29
4.2.2. Set the Input Channels .....	31
4.3. Recording Setup .....	34
4.3.1. Setup the Sampling Speed .....	34
4.3.2. Sampling Speed of Recording Device .....	35
4.3.3. NORMAL Sampling and P-P Sampling Data .....	35
4.3.4. Relationship between Sampling Speed and Chart Speed .....	36
5. TRIGGER SETUP .....	37
5.1. Trigger Types .....	37
5.2. Memory Trigger .....	37
5.2.1. Memory Trigger Setup .....	37
5.3. Pre-Trigger .....	40
5.3.1. Pre-Trigger Setup .....	40
5.4. Start Trigger .....	41

## CONTENTS

5.4.1.	Start Trigger Setup .....	41
6.	MEASURING INPUT SIGNALS.....	42
6.1.	State Transition of Main Unit Operation .....	42
6.2.	Monitor Display and Pen Recording .....	43
6.2.1.	Monitor Display Function .....	43
6.2.2.	Pen Recording .....	46
6.2.3.	Setup and Printing Annotations .....	47
6.3.	Starting and Ending Recording .....	48
6.3.1.	Recording Setup .....	48
6.3.2.	Starting and Ending Recording .....	50
6.3.3.	Pausing Recording and Scrolling Back .....	51
7.	PLAYBACK RECORDED DATA .....	52
7.1.	Select Recorded Data .....	52
7.2.	Playback Recorded Data .....	53
7.2.1.	Thumbnails .....	53
7.2.2.	Cursors .....	54
7.2.3.	Printing Out.....	55
7.3.	Record Management .....	56
7.3.1.	Export - Backing Up Recorded Data .....	57
7.3.2.	Import - Reading Backup Data .....	57
7.3.3.	Restoring Recording Settings.....	58
7.3.4.	Copying Screens and Exporting to External Media.....	58
8.	SPECIFICATIONS .....	60
8.1.	General Specifications.....	60
8.1.1.	Main Unit Basic Specifications .....	60
8.1.2.	General Specifications .....	61
8.2.	Functional Specifications .....	63
8.2.1.	Measurement Function.....	63
8.2.2.	SSD Recording .....	64
8.2.3.	Memory Recording .....	65
8.2.4.	Printer Recording.....	65
8.2.5.	Trigger Function .....	66
8.2.6.	Monitor Function .....	67
8.2.7.	X-Y Waveform .....	67
8.2.8.	FFT Analysis .....	68
8.2.9.	Setup / Record Management .....	69
8.2.10.	Interface Specifications .....	71
8.2.11.	Communication Setup .....	71
8.2.12.	Other Settings (Maintenance / Operation History / Version Management) .....	72
8.3.	Exterior .....	73
8.3.1.	Main Unit Exterior .....	73
	INFORMATION ON SOFTWARE LICENSES .....	74

# 1. Name and Function of Each Block

This product consists of the following blocks.

## 1.1. Name of Each Block

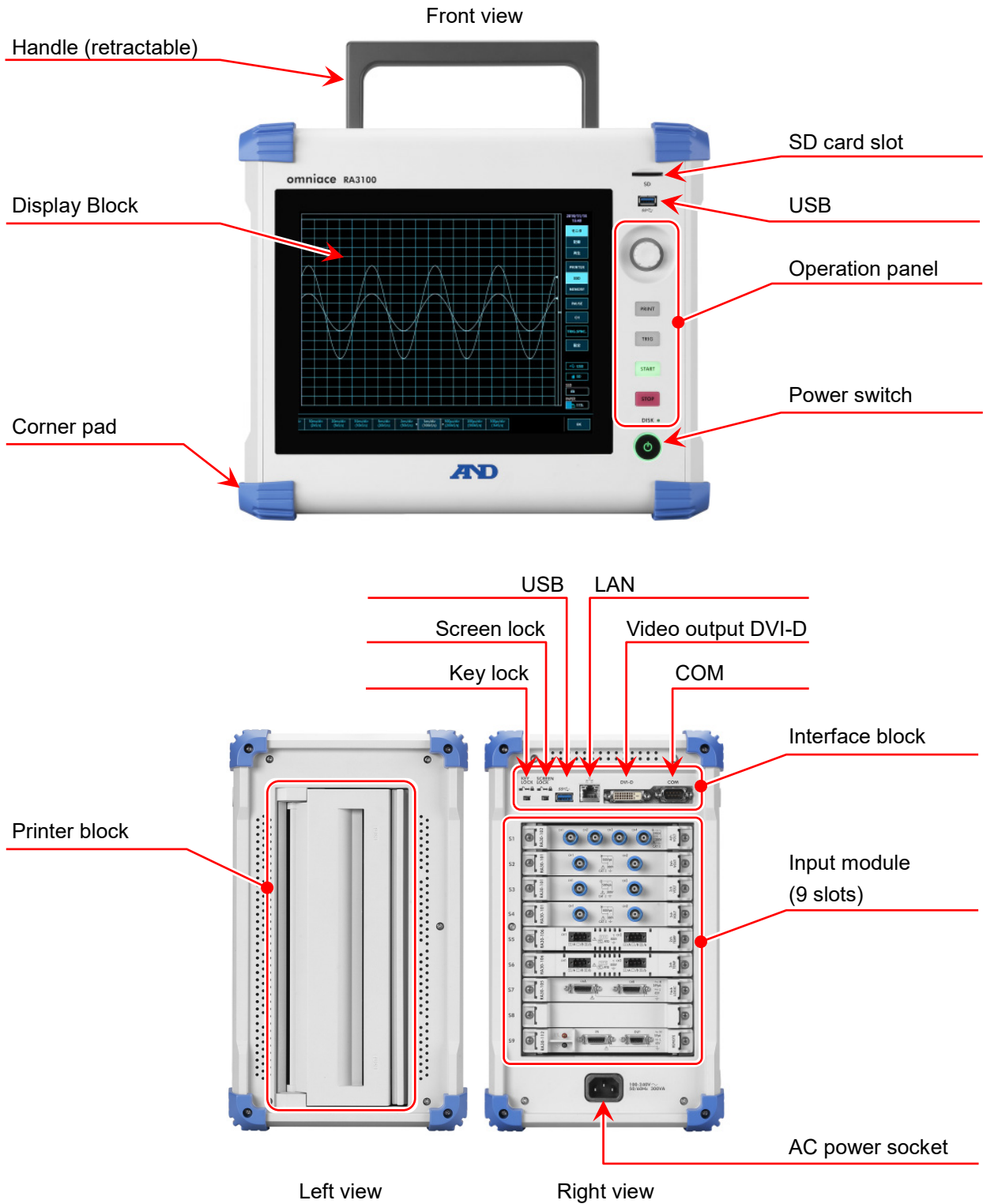

## 1.2. Display Block

This product has a TFT color LCD display with touch panel.

The LCD displays the waveform monitor and settings keys, and users can configure settings by directly touching the panel.

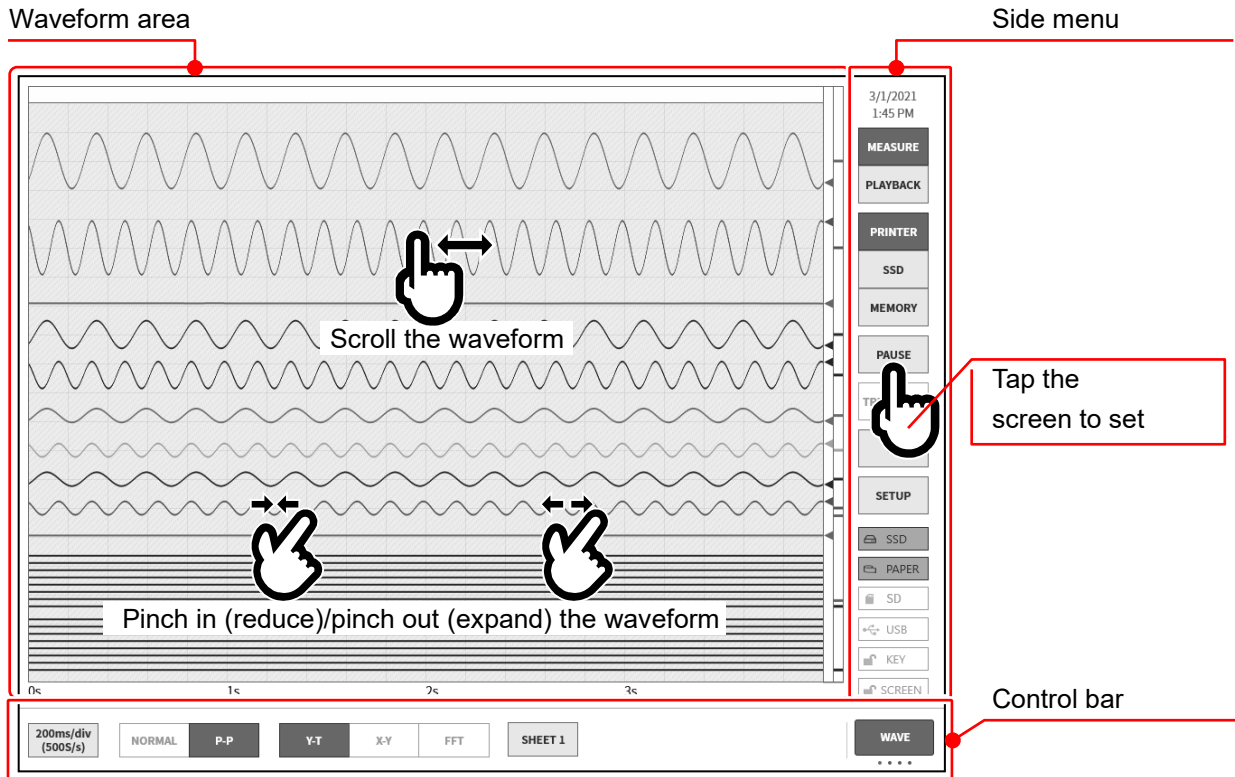

- Waveform area:** You can observe the state of the input signal and play back the recorded data on the waveform monitor. Pinch in/out to enlarge or reduce the waveform or scroll the waveform.
- Side menu:** Used to switch the display screen, configure the various input modules, configure the recording settings, configure recording, set triggers, and display digital data, etc.
- Control bar:** The control bar provides a menu for the functions frequently used with the waveform monitor, such as the basic control of sampling, etc., thumbnail display, cursor display, and pen recorder control.

### NOTE

- The pen recorder control function enables waveform recording to a printer using operations that simulate a conventional pen recorder.
- This product uses an electrostatic capacitive touch panel. The touch screen may not react if you are wearing gloves.

## 1.3. Operation Panel

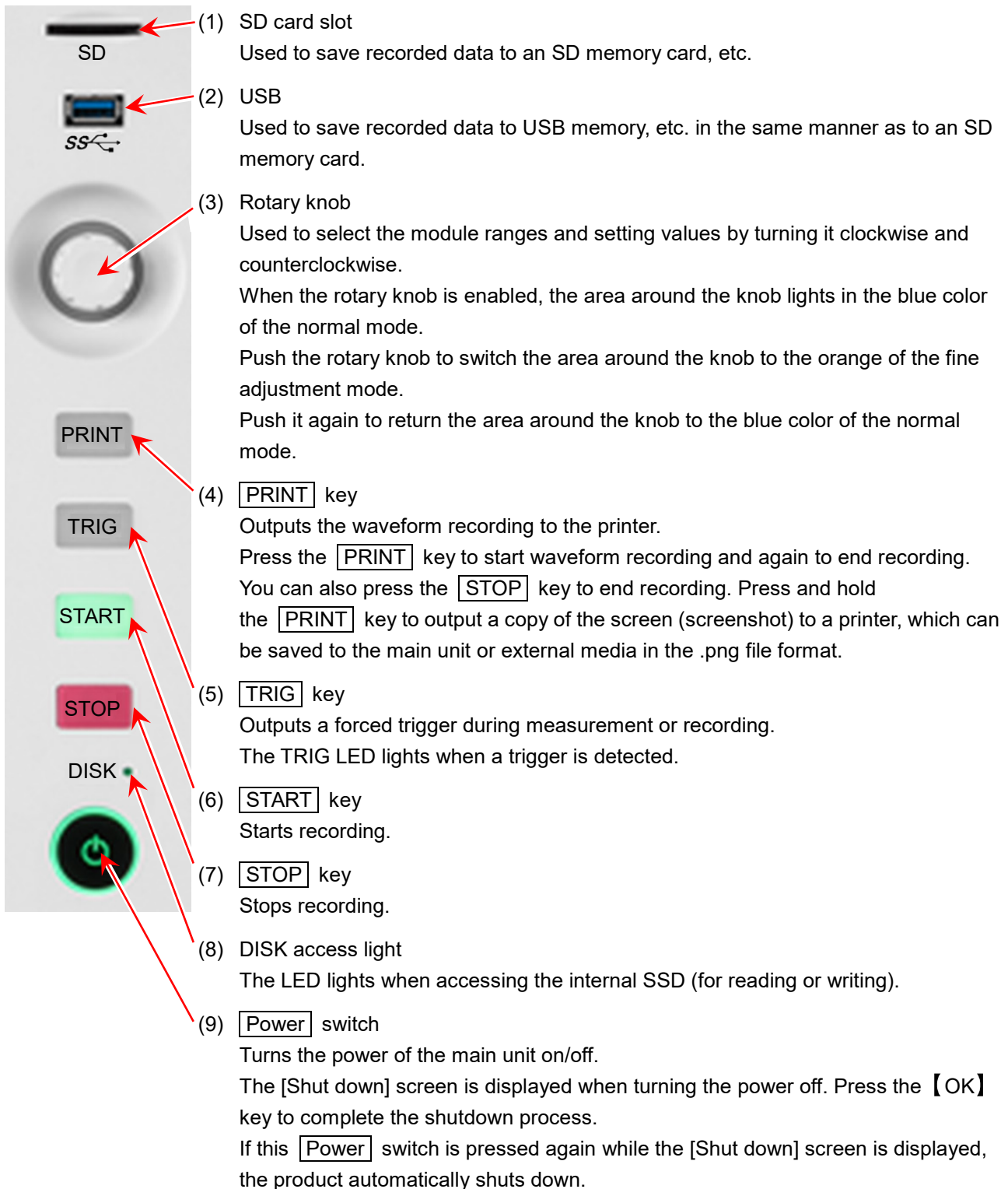

### 1.4. Input Module Block

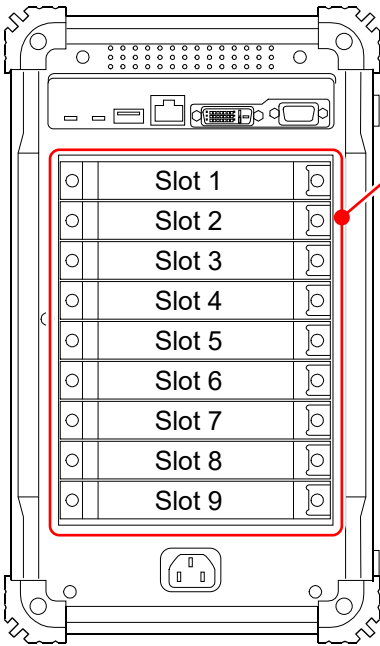

Input Module Block

- Up to nine modules can be installed to the input module block of the product.
- For information on using each module, see the "RA3100 Instruction Manual".
- Standard signal input modules can be installed in any of Slot 1 to Slot 9.
- Select and install a module according to the target for measurement.
- The RA30-112 (remote control module) can only be installed to Slot 9.

### 1.5. Screen and Setup Menu

Waveform area

Side menu

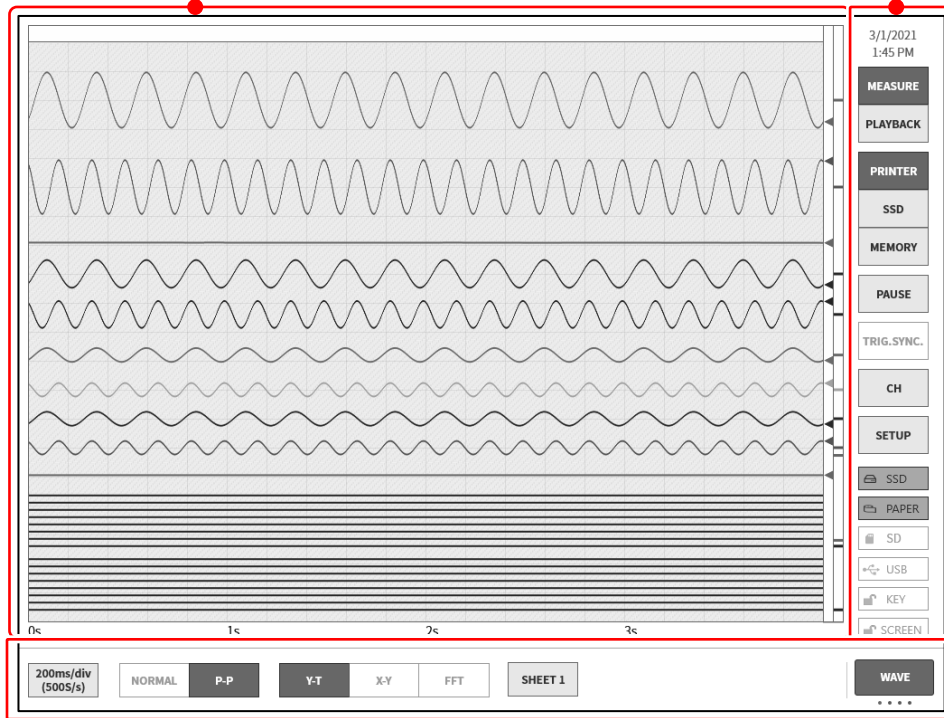

Control bar



### 1.5.1. Side menu

The diagram shows a vertical side menu with the following buttons from top to bottom: 3/1/2021 1:53 PM, MEASURE, PLAYBACK, PRINTER, SSD, MEMORY, PAUSE, TRIG.SYNC., CH, SETUP, SSD (with a lock icon), PAPER (with a paper roll icon), SD (with a card icon), USB (with a stick icon), KEY (with a key icon), and SCREEN (with a screen icon). Red arrows point from numbered callouts to these buttons.

(1) Time:	Displays the current time
(2) MEASURE/PLAYBACK:	Switches the displayed waveform
MEASURE:	Displays the current input waveform.
PLAYBACK:	Displays the playback waveform of saved data.
(3) Waveform display area:	Select waveform recording device to display Displays the recorded waveform for PRINTER/SSD/MEMORY.
(4) PAUSE:	Pauses the waveform displayed on the input monitor.
(5) TRIG.SYNC:	Updates the input waveform display of a memory recording by synchronizing it with a trigger.
(6) CH:	The input channel setup Opens the channel setup sub menu to configure the channel setup, input digital display, and trigger setup.
(7) SETUP:	Opens the setup menu to configure the detailed settings of the product. Recording setup (Recording/Channel list/Sheet/Printer) Main unit setup (Record management/Image management/Environment/ Display) Other setup (Maintenance/Operation history/Version management)
(8) SSD:	Displays the remaining space on the internal SSD. An error is displayed when the remaining space is low.
(9) PAPER:	Displays the remaining amount of recording paper in the printer block. An error is displayed when the remaining amount of recording paper is low. Press and hold this key to initialize the recording paper type (roll paper or Z-fold paper) and usage amount. When replacing the recording paper, press and hold this key to initialize the remaining amount of recording paper.
(10) SD:	Lights when an SD memory card is inserted in the SD card slot and recognized as external memory.
(11) USB:	Lights when a USB stick is inserted in the USB port and recognized as external memory.
(12) KEY:	Lights when the KEY LOCK switch on the side of the main unit is set to on to disable the operation panel keys.
(13) SCREEN:	Lights when the SCREEN LOCK switch on the side of the main unit is set to on to disable the display touch panel.

### 1.5.2. Control Bar

The control bar provides a menu for the functions frequently used with the waveform monitor, such as waveform display control of sampling, etc., thumbnail display, cursor display, and pen recorder control. Tap the (7) **【Display switch】** key on the right edge of the control bar to switch the functions in the order indicated below.

**【PENREC】** (pen recording) is only available when printer recording is selected.

**【WAVE】** ⇒ **【THUMBNAIL】** ⇒ **【CURSOR】** ⇒ **【PENREC】**

#### WAVE (waveform)

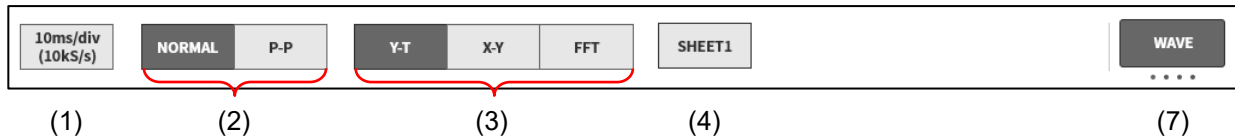

(1) Sampling speed : Selects the sampling speed. The speed table differs according to the recording device.

Printer recording : 1 kS/s (100 ms/div) to 10 S/s (10 min/div)

SSD recording : 1 MS/s (100 μs/div) to 10 S/s (10 min/div)

Memory recording : 20 MS/s (5 μs/div) to 10 S/s (10 min/div)

(2) Data format : Selects either NORMAL or P-P as the format for the recorded data.  
Only P-P is available for printer recording.  
Only NORMAL is available for memory recording.

(3) Waveform format : Selects Y-T, X-Y, or FFT as the waveform format.  
X-Y display and FFT analysis are only available when SSD recording is set.

(4) Sheet selection : Selects the waveform set to display on the screen.

(7) Display switch : Switches the functions in the order **【WAVE】** → **【THUMBNAIL】** → **【CURSOR】** → **【PENREC】**.

#### THUMBNAIL

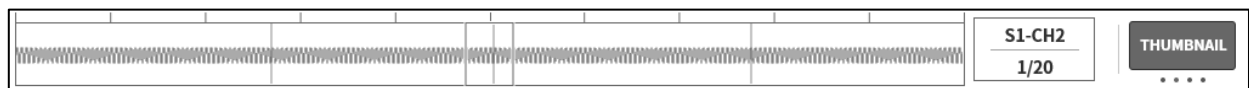

#### CURSOR

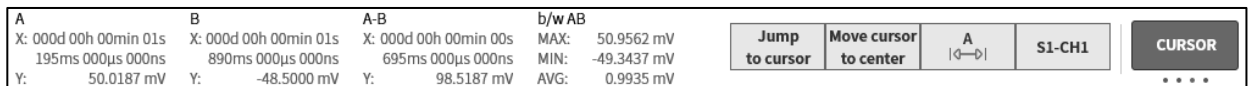

#### PENREC (pen recording)

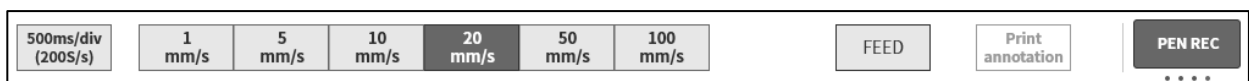

## Control bar when playback

Touch the **【PLAYBACK】** key on the side menu to enter the playback mode and switch the control bar to the menu for playback.



- (1) Sampling speed : Displays the sampling speed of the recorded data.  
 Printer recording : 1 kS/s (100 ms/div) to 10 S/s (10 min/div)  
 SSD recording : 1 MS/s (100  $\mu$ s/div) to 10 S/s (10 min/div)  
 Memory recording : 20 MS/s (5  $\mu$ s/div) to 10 S/s (10 min/div)
- (2) Data format : Displays either NORMAL or P-P as the format for the recorded data.  
 Only P-P is available for printer recording.  
 Only NORMAL is available for memory recording.
- (3) Waveform format : Selects Y-T, X-Y, or FFT as the waveform format.  
 X-Y display and FFT analysis are only available when SSD recording is set.
- (4) Sheet selection : Selects the waveform set to display on the screen.
- (5) DATA : Selects and play back recorded data.
- (6) DATA information : Displays information for the displayed playback data.
- (7) Display switch : Switches the functions in the order **【WAVE】**  $\rightarrow$  **【THUMBNAIL】**  $\rightarrow$  **【CURSOR】**  
 $\rightarrow$  **【PENREC】**.

## 2. Pre-Measurement Procedures

### 2.1. Before Switching On the Power

The preparations for using this product and the cautions are explained below.

#### 2.1.1. Installation and Usage Environment

Use this product on a flat, level surface.

When using the printer, install it so that the recording paper is level as indicated in the figure on the right.



### CAUTION

#### Cautions Regarding the Installation Environment

- ❑ Use this product at locations that satisfy the overvoltage requirement, the Category II (CAT II) of the safety standard for electrical measurement instruments in EN61010-1.
- ❑ This product has a Pollution Degree of 2.
- ❑ Use this product in the following operating environments.  
Operating temperature range: 0 to 40°C    Operating humidity range: 35 to 85% RH (without condensation)
- ❑ Do not use this product at the following locations. In addition, carefully check the environment when using this product.
  - Locations where the temperature and humidity rise due to direct sunlight or heaters
  - Wet locations
  - Locations where salt, oil, or corrosive gases exist
  - Dusty locations
  - Locations subject to strong vibrations
  - Locations with a strong electromagnetic field
  - This product is provided with ventilation openings in order to prevent overheating. Ensure that the ventilation openings remain unobstructed by covers or materials. Otherwise, the internal temperature of the product rises, causing malfunctions.

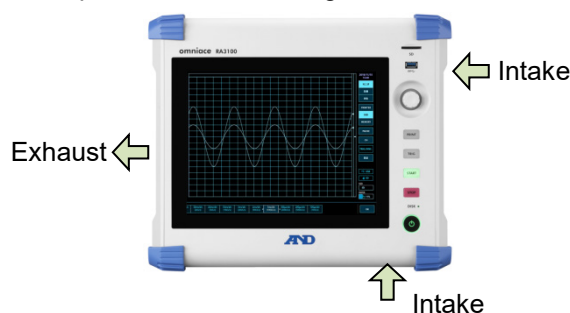

- Do not place highly combustible objects such as paper near the product.

## 2.1.2. Installing Input Modules

### WARNING

- ❑ In order to prevent electrocution and damage to the product, make sure to turn the power off and remove the power cable and signal input cable from the main unit before replacing an input module.
- ❑ In order to prevent electrocution or damage to the main unit caused by infiltration of foreign material, make sure to install the included empty panels to unused slots.

### Installation Procedure

- Step 1. Turn the power OFF.
- Step 2. Disconnect the power cable.
- Step 3. Grip the handles on both edges and insert the module straight in along the guide rails. The module type should be on the operation panel side.
- Step 4. Tighten the screws on both edges with a Phillips head screwdriver (No. 2).

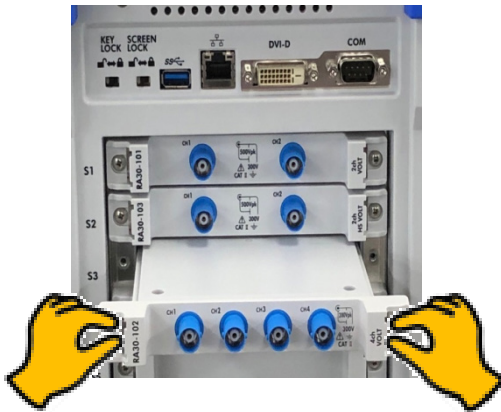

### Removal Procedure

- Step 1. Turn the power OFF.
- Step 2. Remove the connected input cable.
- Step 3. Disconnect the power cable.
- Step 4. Loosen the screws on both edges with a Phillips head screwdriver.
- Step 5. Grip the handles on both edges and pull the module straight out.
- Step 6. Install an empty panel if the slot will not be used.

### 2.1.3. Paper Loading

The procedure for loading recording paper to the printer block is indicated below.

Load the recording paper to this product. There are two types of recording paper: paper rolls and Z-fold paper.

For information on loading Z-fold paper, see the "RA3100 Instruction Manual".

Raise the lever to open the printer cover.

Lever

Recording paper outlet

Printer cover

Z-fold paper inlet

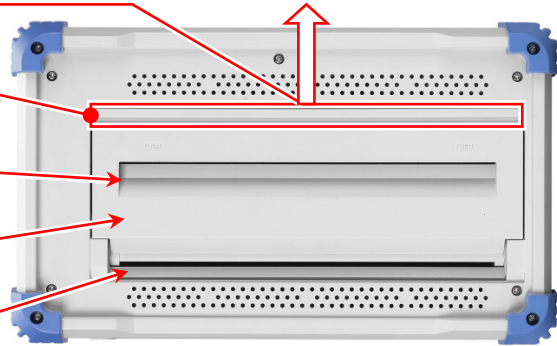

### Paper Loading Procedure

Step 1. Attach the paper holders to the paper roll.

Attach a paper holder to both ends of the paper roll. When loading a partially used roll, trim the edges for ease of loading, as shown in the figure.

The inside of the roll paper is the back side and the outside is the thermal surface that is printed on.

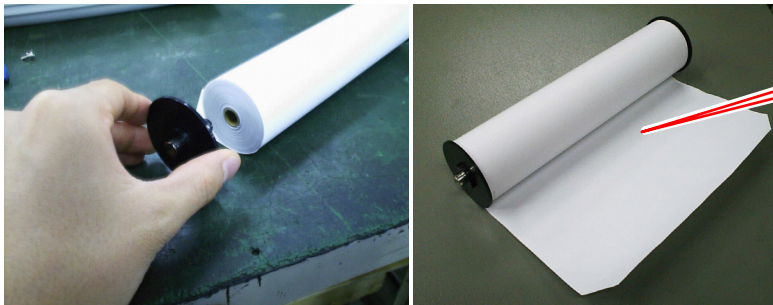

Step 2. Open the printer cover by raising the lever of the printer block.

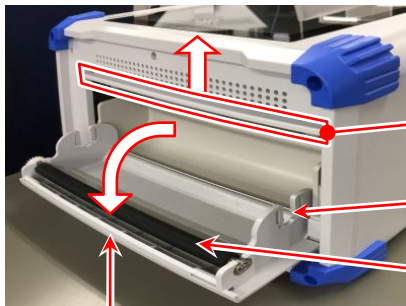

Pull the lever upwards.

Recording paper guide (the U-shaped groove)

Platen roller (black roller)

Recording paper outlet

Step 3. Load the paper following the guide of the product.

**NOTE**

- Load the recording paper following the guide of the product, and press the paper holders into the guide until a click is heard. Be sure the paper roll is loaded so that the thermally sensitive side is faced toward you; if this side is faced away, the paper cannot be printed. If the recording paper is not loaded securely, printing problems may occur or the recording paper may meander.

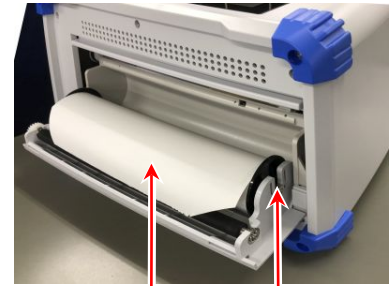

Check the winding direction carefully  
Push it in so that the thermally sensitive side is faced up

Insert the paper holders into the guide of the printer block

Step 4. Feed the recording paper to the recording paper outlet. Insert the recording paper from above the platen roller of the printer block (black roller) from the recording paper outlet of the printer cover and pull it out about 10 cm.

Step 4-1. Feed the paper to the recording paper outlet from above the platen roller.

Step 4-2. Pull the recording paper out from the recording paper outlet about 10 cm.

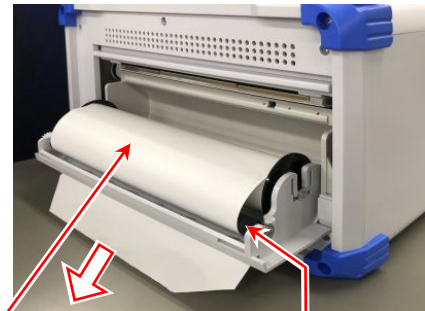

Recording paper

Platen roller

Step 5. Close the printer cover. After pulling the paper, close the cover firmly pressing down on both sides (until a click is heard). Pull the paper out keeping it straight. When using without both sides of the paper pushed into the recording section, recording cannot be performed correctly.

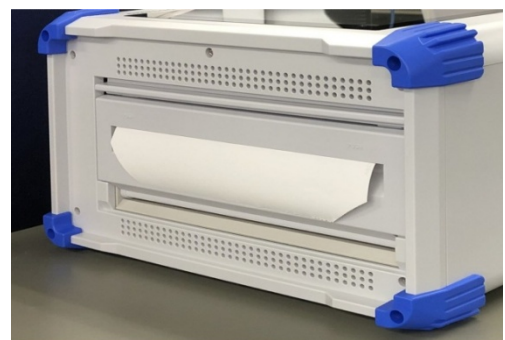

## 2.2. Turning the Power On/Off

### 2.2.1. Connecting the AC Power Cable

Be sure to check the following points before connecting the AC power cable to this product.

- Make sure that the power supply matches the rating indicated on the rating plate attached to this product.
- Ensure amp or interface units are inserted securely.

#### **WARNING**

- This product must be grounded before turning on the power.
- This grounding protection is for the safety of this product, as well as for that of the user and peripheral equipment.
  - If the AC power cable that comes with this product is connected to a 3-pin power outlet equipped with a protective conductor pin, the product is automatically grounded.
  - Do not use an extension cable without protective grounding.
  - Do not use this product when protective grounding cannot be performed using a power outlet that matches the supplied AC power cable.

### 2.2.2. Turning On the Power

Step 1. Perform the check indicated below.

<Items to check before turning on the power>

- Is this product installed in a safe location?
- Is the usage environment OK?
- Is the top of the touch panel free from any writing implements or tools, etc.?

Step 2. Upon confirming that all of the above check items are fine, connect the inlet side of the AC power cable to the AC socket of this product.

Step 3. Connect the plug of the AC power cable to the power outlet.

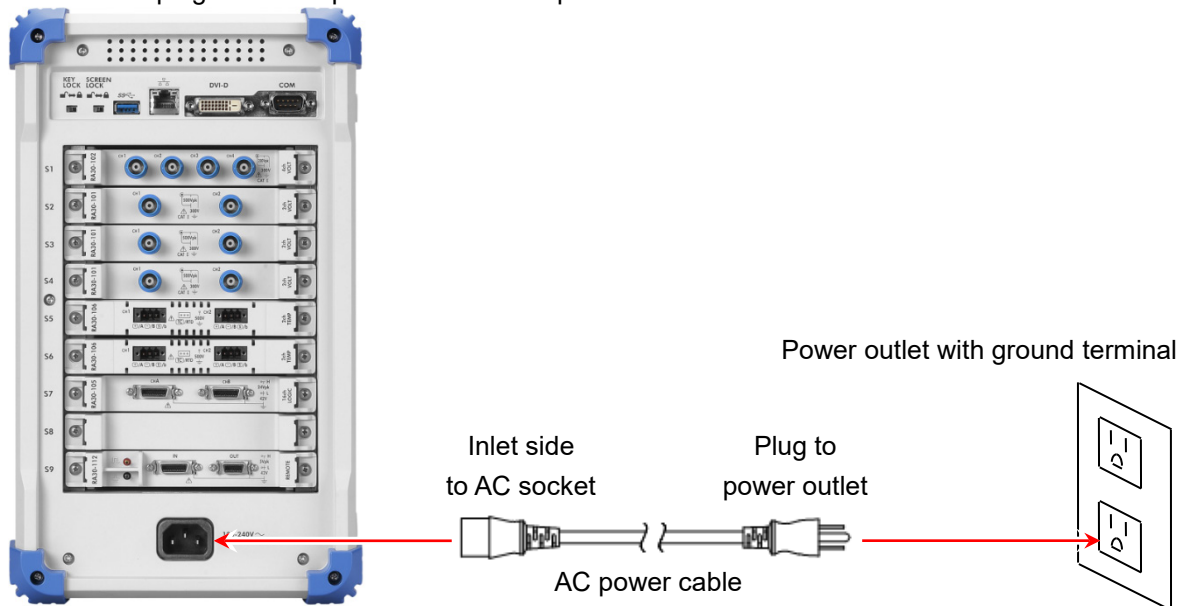



Step 4. Turn the **Power** switch of the product on.  
 When the power switch on the operation panel of the product is turned on, the green LED lights up and the power turns on.

**NOTE**

- Standby current flows to this product when the AC power cable is connected to the power outlet.
- Remove the power cable when the product will not be used for an extended period of time.

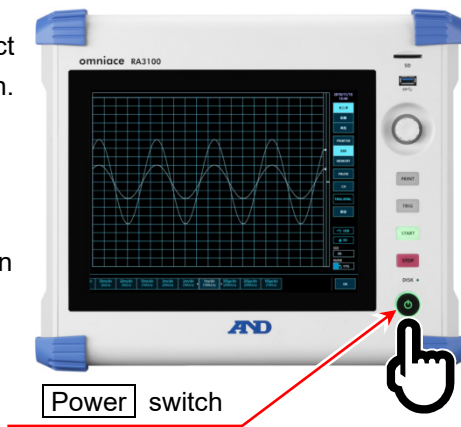

### 2.2.3. Confirming Normal Startup

The monitor screen of the RA3100 is displayed about one minute after turning the power on.

**NOTE**

- Do not touch the touch panel until the waveform monitor is displayed. Doing so may lead to erroneous operations.
- Immediately after purchase or initializing the main unit, measurement is turned off for all channels and no waveform is displayed.

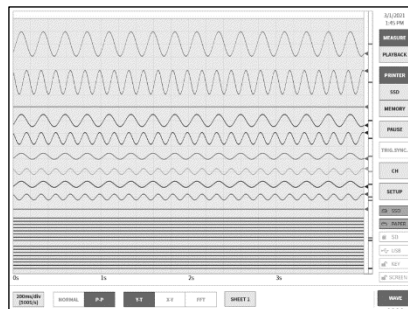

### 2.2.4. Preparing for More Precise Measurements

Warm up the product for about 60 minutes after turning on the power in order to perform more precise measurements.

After the warm up is complete, perform "Zero adjust" of the input modules.

See "4.Setup Measurement".

This completes the preparations for measurement.



### 2.2.5. Turning Off the Power

Step 1. When the **Power** key on the operation panel is pressed while the power is on, the shut down process starts and the [Shut down] dialog box indicated below is displayed on the center of the screen. Tap the **OK** key to shut down the product. Tap the **Cancel** key to continue without turning off the power.

If the **Power** key is pressed again while the [Shut down] dialog box is displayed, the product automatically shuts down.



**⚠ CAUTION**

- Make sure to shut down the product to turn off the power, as directly removing the power cable from the power outlet without shutting down can damage the files in the internal storage.

# 3. Flow of Measurement

This product records and play back input signals following the procedures described below.

## 3.1. Flow of Measurement

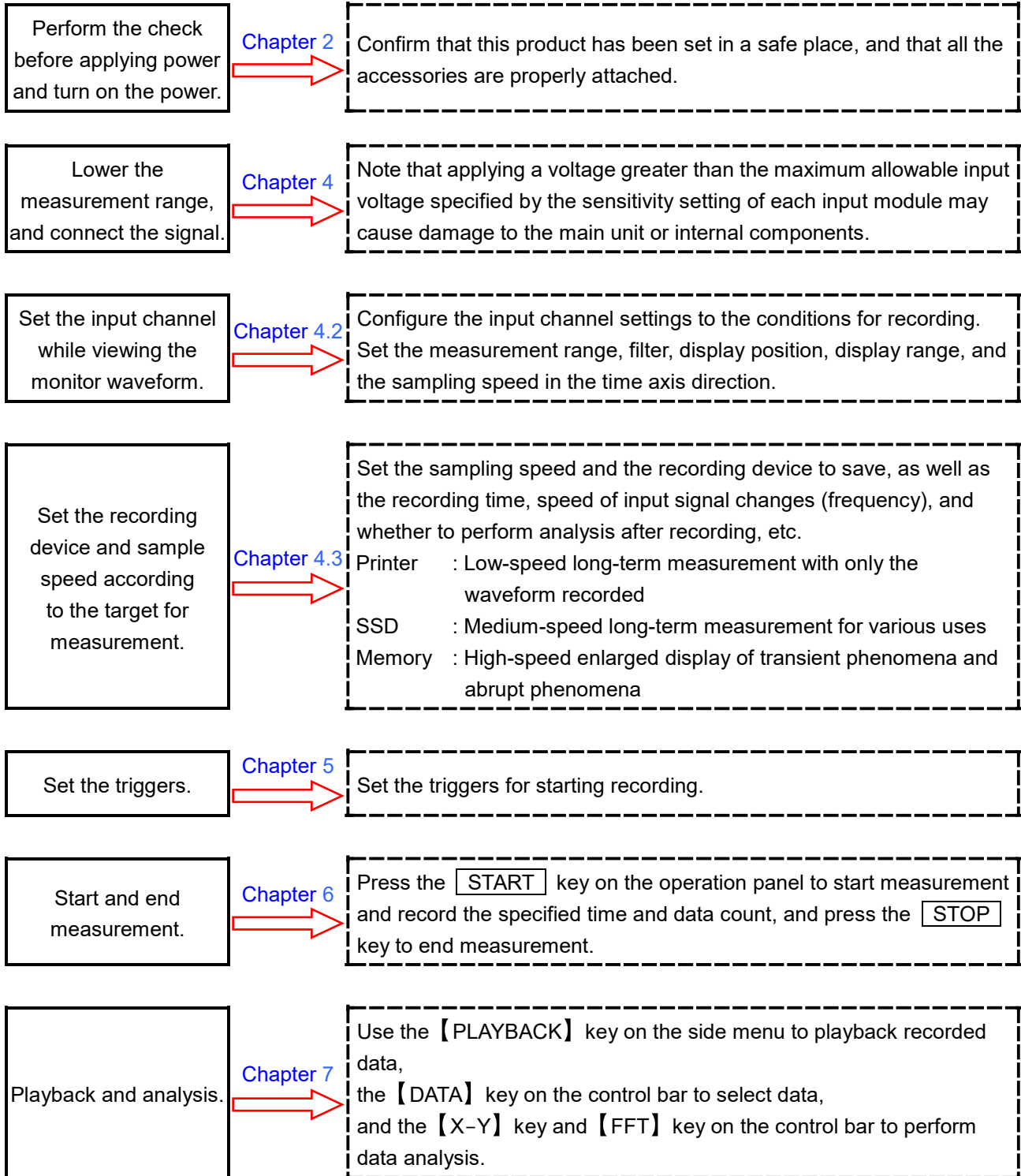

## 4. Configuring Measurement

### 4.1. Reducing the Input Sensitivity and Connecting the Input Cable

- Step 1. The input signal can be displayed and checked in realtime by switching the **【MEASURE /PLATBACK】** key on the side menu to **【MEASURE】**.
- Step 2. Tap the **【CH】** key on the side menu to display the channel setup sub menu.
- Step 3. When the **【Meas. range】** key is tapped in the channel setup sub menu, the border turns orange, the area around the rotary knob turns blue, and the rotary knob can be used to change the setting.
- Step 4. Turn the rotary knob counterclockwise to set the minimum input sensitivity.  
(Turning the rotary knob clockwise increases the sensitivity.)

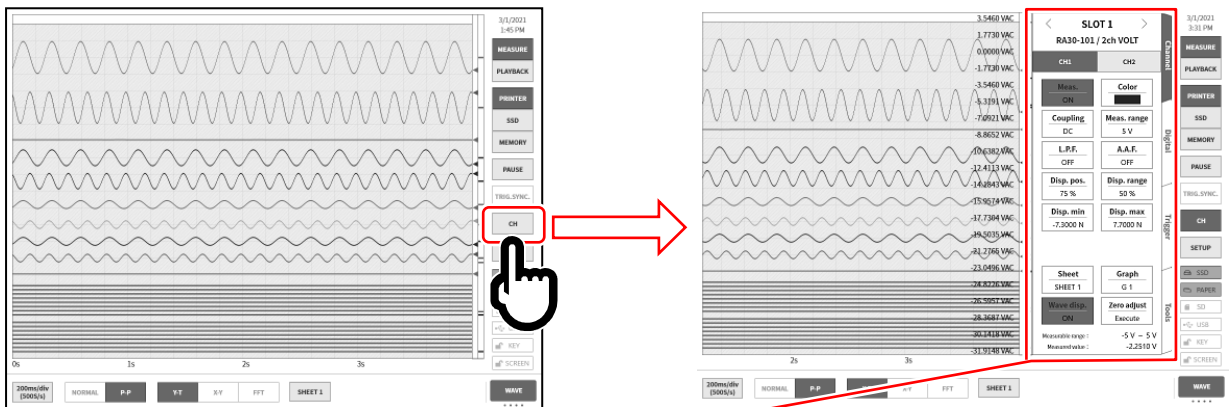

Channel setup sub menu

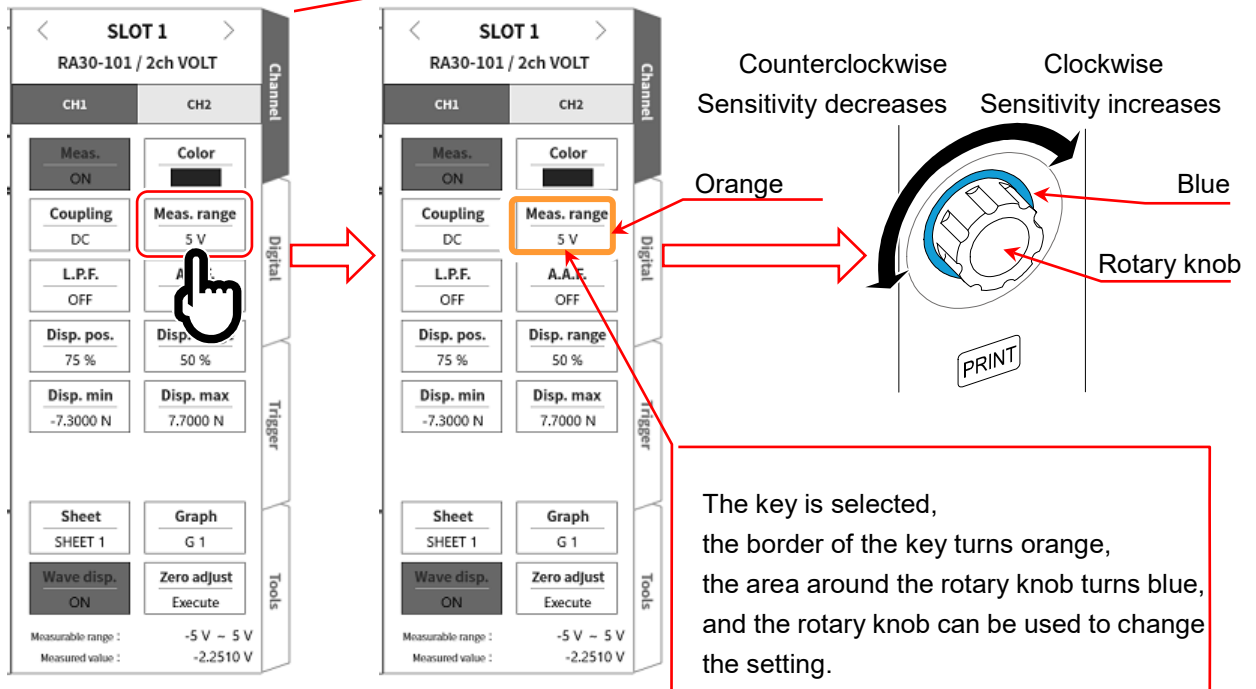

#### 4. Configuring Measurement - 4.1. Reducing the Input Sensitivity and Connecting the Input Cable

---

- Step 5. Tap the **【CHx】** tab in the channel setup sub menu to change the displayed channel.
- Step 6. To change the display slot of the input module, swipe the channel setup sub menu left or right, or tap the **【<】** or **【>】** key on the top.
- Step 7. Next, connect the insulation BNC cable (standard) to the BNC terminal of the input module.

### **WARNING**

- Do not input voltages that exceed the maximum allowed input voltage or withstand voltage to an input module.

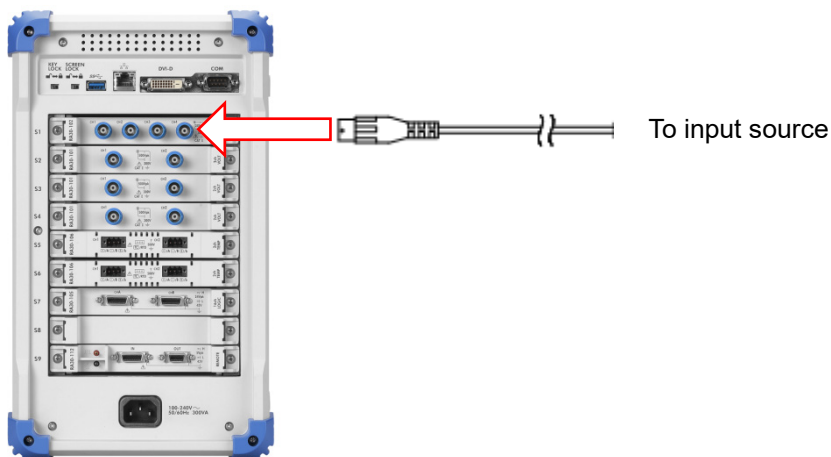

## 4.2. Setup the Input Channel

### 4.2.1. Channel Setup sub menu (For RA30-101)

(1) Slot number, input module type

(2) Change slot:

You can change the display slot by swiping this sub menu left or right or tapping the left [ < ] and right [ > ] key.

(3) Select channel: Select the channel in the slot.

(4) Meas. ON/OFF

ON: Measure and record the input signal.

(5) Color: Change the display color of the waveform monitor.

(6) Coupling: Switch the input signal coupling in the order DC → GND → AC.

(7) Meas. range:

Change the measurement range of the input channel. When this key is tapped, the rotary knob is enabled (the LED lights up) and the range can be changed by turning the knob.

(8) L.P.F.:

Change the low-pass filter of the input channel. When this key is tapped, the rotary knob is enabled (the LED lights up) and the filter can be changed by turning the knob.

(9) A.A.F.: Turns the anti-aliasing filter of the input channel on or off.

(10) Disp. pos.: Specify the position of the waveform monitor to display the specified range of the waveform display area. Specified as a percentage indicating the center position of the display range from the bottom of the graph when the full range of each graph is 100%.

(11) Disp. range: Specifies the display width in the amplitude direction of each graph.

Specified as the percentage of the display width when the full range of each graph is 100%.

Example) When the number of graph divisions is 1 and 50% is set, the waveform display is 10 div of the total width of 20 div.

(12) Disp. min: Set (by tapping the key and turning the knob) the display lower limit value (scale value) of the bottom of the display range.

(13) Disp. max: Set (by tapping the key and turning the knob) the display upper limit value (scale value) of the top of the display range.

(14) Sheet: Set the monitor display/printer print sheet of the set channel.

(15) Graph: Set the graph.

Tap the key to enable (light the LED of) the rotary knob, then turn the knob to change the graph.

(16) Wave disp.: When ON, the waveform is displayed. When OFF, the waveform is not displayed.

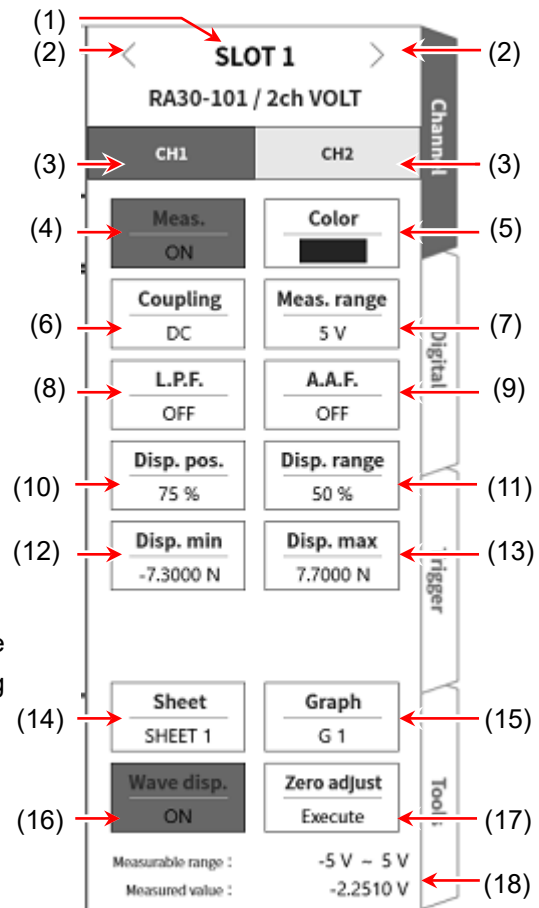

#### 4. Configuring Measurement - 4.2. Setup the Input Channel

---

- (17) Zero adjust: Cancels the input offset of the input channel. Execute zero adjust to perform more accurate measurement.
- (18) The available range and current measurement value monitor.

### 4.2.2. Set the Input Channels

The input waveform is displayed on the monitor when a signal is connected to the input module.  
 The overall procedure for setting the input channel is indicated below. See the following for details on each step.

- Step 1. Set coupling. (When the input module is a voltage module)
- Step 2. Set the measurement range according to the target for measurement.
- Step 3. Set the input filter.
- Step 4. Set the display range and display position.
- Step 5. Set the display minimum and display maximum.
- Step 6. Execute zero adjust.

#### Description of Step 1 (setting coupling)

Select the input coupling using the Coupling key in the channel setup sub menu.  
 Tap the Coupling key and turn the rotary knob to change the setting in the order DC → GND → AC.

Coupling	Contents
DC	Enables measurement of the actual input signal, including the DC and AC component.
AC	Measures the AC component of the input signal only. Set this when you want to measure only the amplitude of an AC signal, as it cancels the DC offset of the signal.
GND	Connects the channel input to GND without connecting the input signal inside the channel. Enables the input GND level to be checked with waveform monitoring or printer recording.

#### Description of Step 2 (setting the measurement range)

The input sensitivity can be changed in **Meas. range** in the channel setup sub menu.  
 The value displayed for the measurement range (RANGE) indicates the input (measurement) maximum value and corresponds to 10 div on the waveform monitor. When the display position is 50%, the full measurement range of ±RANGE (20 div) is displayed.

When the **Meas. range** key is tapped in the channel setup sub menu, the border turns orange, the area around the rotary knob turns blue, and the rotary knob can be changed.  
 Turn the rotary knob counterclockwise to reduce the sensitivity and clockwise to increase the sensitivity.  
 The setting values of the measurement range differ according to the type of input module.  
 For details, see the "RA3100 Instruction Manual".

When the input exceeds the measurement range and an over range occurs, **[OVER RANGE]** is displayed on the bottom right of the screen and the main unit emits a warning beep if the buzzer is enabled. Reduce the sensitivity with the measurement range so that the input signal does not exceed the range.

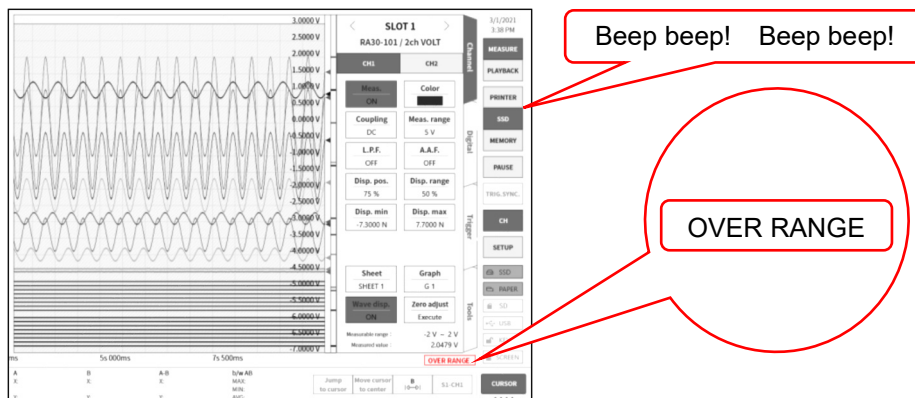

### Description of Step 3 (setting the filter) (procedure on page 29)

Set the filter of the selected channel.

This cuts out unnecessary frequency components and noise. As the filter differs according to the input module type, set the filter according to the characteristics of the input signal and measurement.

Low-pass filter (L.P.F.)

A gently sloping attenuation filter. Set the cutoff frequency in consideration of the frequency of the input signal.

Anti-aliasing filter (A.A.F.)

A steeply sloping attenuation low-pass filter. Enable this filter to automatically set the filter so that aliasing of the A/D data does not occur due to the sampling speed.

### Description of Step 4 (setting the display range and display position (waveform display area)) (procedure on page 29)

When displaying multiple channels, it may be difficult to recognize them because the waveforms overlap. Reducing the input sensitivity in the measurement range decreases the amplitude and changes the display position, which can stop the waveforms from overlapping and make them easier to recognize, but this also reduces the resolution of the data. The display range and display position settings can be used to change the display scale and display position of the waveform amplitude direction without reducing the resolution of the data of the channel being displayed.

Disp. range:

The display width in the amplitude direction of the waveform display area on the waveform monitor.

Specified as the percentage of the display width when the full range of each graph in the vertical direction is 100%.

Example) When the number of graph divisions is 1 and 40% is set, the waveform display is reduced to 8 div of the total width of 20 div.

Disp. pos.:

Specify the position of the waveform monitor to display the specified range of the waveform display area.

Specified as a percentage indicating the center position of the display range from the bottom of each graph when the full range of the monitor in the vertical direction is 100%.

When the **【Disp. range】** key or **【Disp. pos.】** key is tapped, the rotary knob is enabled and the setting value can be changed by turning the knob. The key can also be pressed and held to display numeric keys for directly entering values.

Relationship between the display range and display position of the input channel

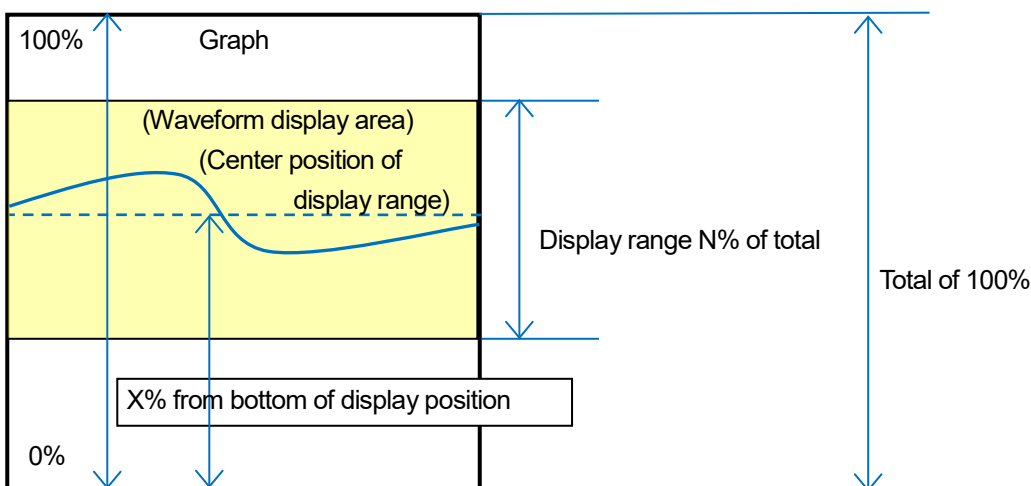



## Description of Step 5 (setting the display maximum and display minimum (waveform display scale)) (procedure on page 29)

If the amplitude of the input signal is smaller than the set range, the signal change may be hard to recognize.

In this case, you can change the scale of the upper limit value and lower limit value for the display range to enlarge the amplitude of the displayed signal.

Disp. max: Set the display upper limit value of the top of the display range.

Disp. min: Set the display lower limit value of the bottom of the display range.

When the **【Disp. max】** or **【Disp. min】** key is tapped, the rotary knob is enabled and the setting value can be changed by turning the knob. The key can also be pressed and held to display numeric keys for directly entering values.

Relationship between the display maximum and display minimum of the input channel

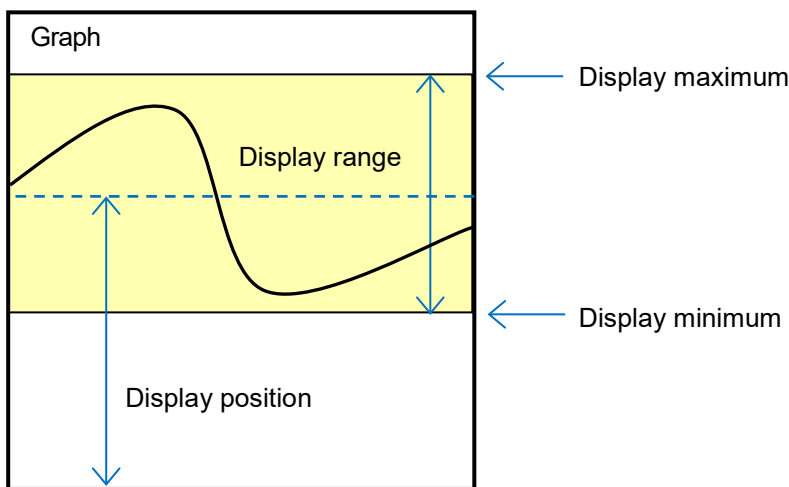

### NOTE

- If the sensitivity of the measurement range is increased to enlarge the amplitude, the amplitude of the input signal will only become a little bigger and the range may be exceeded or the input maximum value may not be able to be read, etc.

If the display is enlarged by changing the scale, the recorded data is recorded until the value set in the measurement range, and the display can only be enlarged.

## Description of Step 5 (zero adjust) (procedure on page 29)

After turning on the power, the internal temperature of the product will rise as time elapses, and cause temperature drift inside the input module, which leads to errors in the measurement data.

Execute zero adjust to cancel these errors.

In order to perform measurement with few errors, let the product warm up for 60 minutes after turning on the power, then tap the **【Zero adjust】** key in the channel setup sub menu to cancel the input drift. This function may not be available, depending on the type of input module.

### NOTE

- This function is for canceling internal offset and drift, and does not cancel the offset of the input signal.

## 4.3. Recording Setup

### 4.3.1. Setup the Sampling Speed

An image of the waveform recorded on the selected recording device (PRINTER, SSD, or MEMORY) is displayed on the waveform monitor.

The sampling speed of the image waveform recorded on the selected recording device is displayed on the left edge of the control bar.

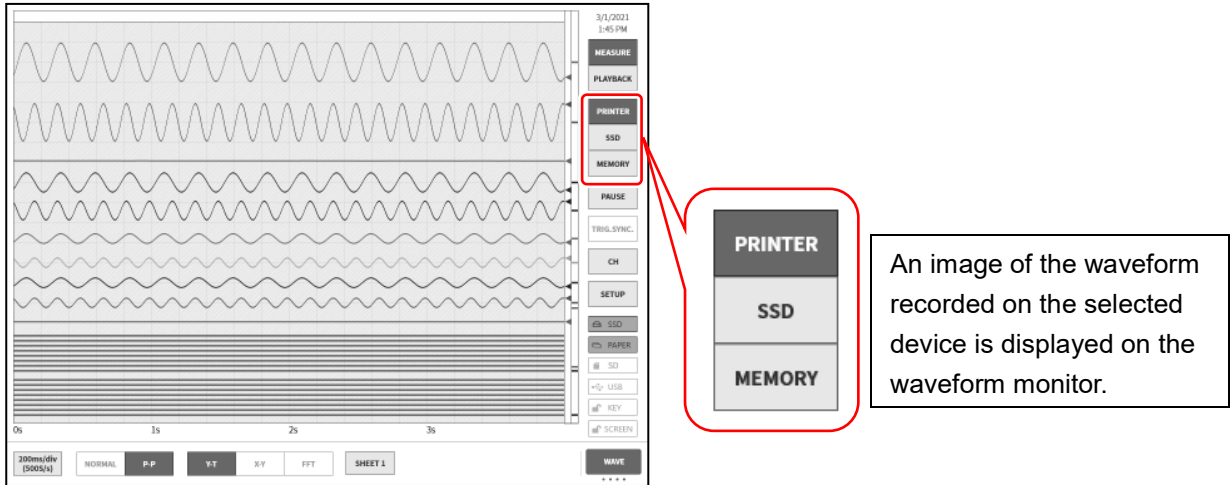

Tap to display the selectable sampling speed table.

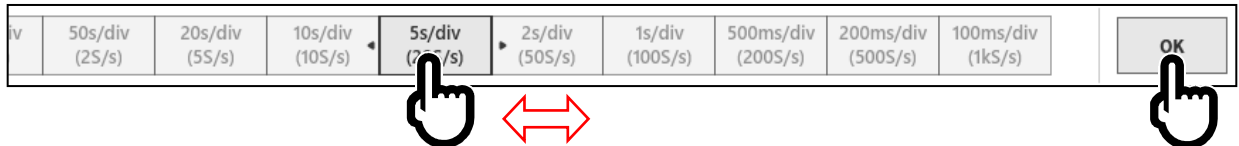

Tap the sampling speed to display the waveform sampled at that speed.

Drag the table to the left or right to display the hidden speed table.

When the sampling speed is decided, tap **【OK】** on the right edge to close the table.

### 4.3.2. Sampling Speed of Recording Device

There are three types of recording device (PRINTER, SSD, and MEMORY).

The sampling speed setting range and characteristics of each device are indicated below.

PRINTER	Setting range	100 ms/div (1 kS/s) to 10 min/div (10 S/min)
	Characteristics	Records the waveform to the long-term printer at low speed. Because the waveform is directly recorded to the recording paper, it is easy to confirm the input signal and suitable for viewing long-term trends. The recorded data is internally sampled at 20 MS/s and the waveform is recorded with P-P data, which enables recording of high-speed signals without loss.
SSD	Setting range	100 $\mu$ s/div (1 MS/s) to 10 min/div (10 S/min)
	Characteristics	Records the long-term data to the SSD at medium speed. NORMAL or P-P can be selected for the recorded data. When recorded with NORMAL data, FFT or X-Y analysis is possible in addition to standard Y-T waveforms. For P-P data, the data can be recorded for extended periods at a speed where the printer cannot record.
MEMORY	Setting range	5 $\mu$ s/div (20 MS/s) to 10 min/div (10 S/min)
	Characteristics	Records the data to the internal memory with high-speed sampling. The data is recorded when the trigger conditions set in advance are detected, and recording automatically ends when the specified sample count has been recorded. Only NORMAL can be selected for the recorded data. This is suitable for sudden input signals, rise/fall time, and measurement of the delay between signals.

### 4.3.3. NORMAL Sampling and P-P Sampling Data

This product has two data formats: NORMAL and P-P.

#### Normal Sampling

With normal sampling, the A/D value of the sampling period is recorded as data and used for waveform reproduction and data analysis.

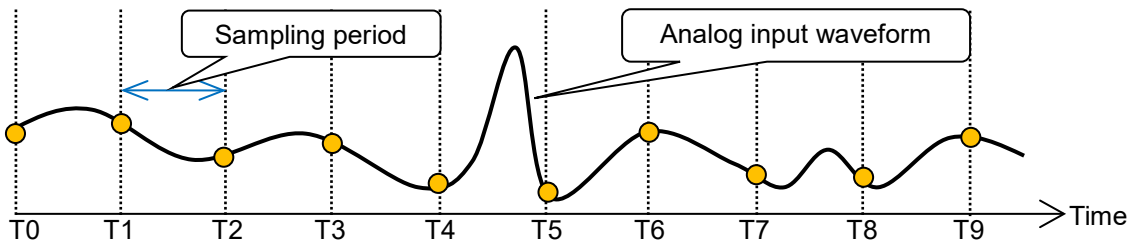

If the input signal is too fast for the sampling period, the waveform reproducibility may drop and lead to the unexpected loss of pulses. Raising the sampling speed improves the waveform reproducibility but increases the recorded data.

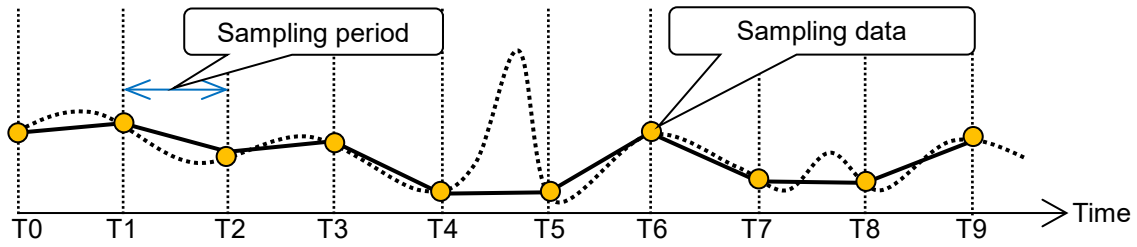

### P-P Sampling

P-P sampling performs sampling with the data within the sampling period as the fastest sampling (20 MS/s), to detect the peak values (maximum value and minimum value) and record those peak values as the recorded data.

This data format is suitable for the waveform playback of long-term recording, as it enables waveform reproducibility of a wide band of data, without sudden spike noise, etc.

A disadvantage is that it cannot perform data analysis after recording (average, RMS, FFT, etc.)

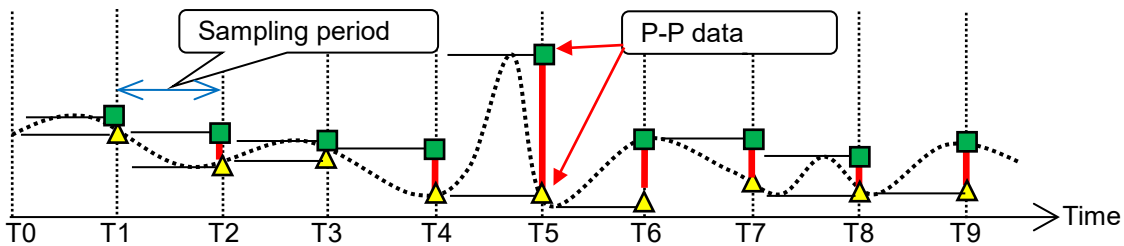

#### 4.3.4. Relationship between Sampling Speed and Chart Speed

The relationship between the sampling speed of this product and the chart speed of a conventional chart recorder is indicated in the table below.

Sampling Speed	Chart speed
100 ms/div (1 kS/s)	100 mm/s
200 ms/div (500 S/s)	50 mm/s
500 ms/div (200 S/s)	20 mm/s
1 s/div (100 S/s)	10 mm/s
2 s/div (50 S/s)	5 mm/s
5 s/div (20 S/s)	2 mm/s
10 s/div (10 S/s)	1 mm/s
20 s/div (5 S/s)	30 mm/min
50 s/div (2 S/s)	12 mm/min
100 s/div (1 S/s)	6 mm/min
2 min/div (50 S/min)	5 mm/min
5 min/div (20 S/min)	2 mm/min
10 min/div (10 S/min)	1 mm/min
EXT.	0.1 mm/pulse

## 5. Trigger Setup

### 5.1. Trigger Types

This product has two types of triggers :

Memory trigger for memory recording and Start trigger for starting recording.

### 5.2. Memory Trigger

Memory trigger is a signal for enabling memory recording, and is occurred when the trigger conditions of the channel specified in the trigger source are established.

When a trigger is detected, memory recording is performed with the data count set in the pre-trigger and memory block size, which represents a single recording operation. When the number of blocks to record is set to a multiple number, recording starts for the next block when one block has finished recording.

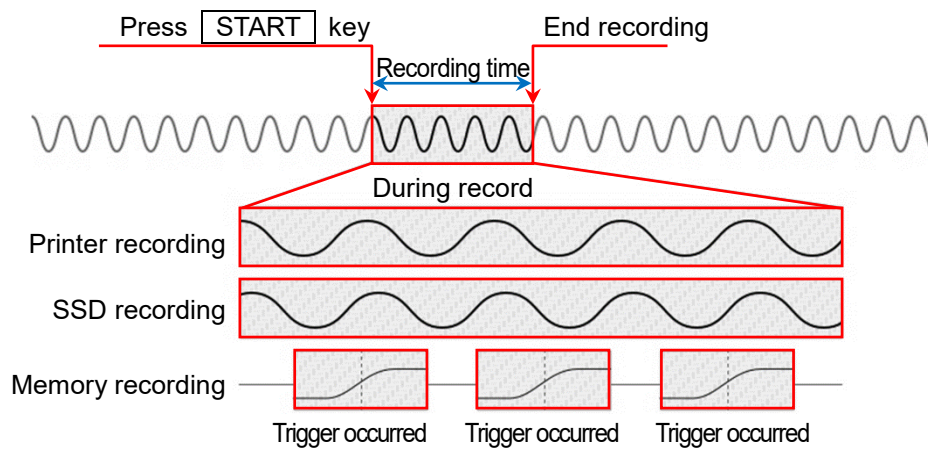

#### 5.2.1. Memory Trigger Setup

Step 1. Tap the **[CH]** key on the side menu to display the channel setup sub menu.

Step 2. Tap the **[Trigger]** tab on the bottom right of the channel setup sub menu to display the trigger setup screen.

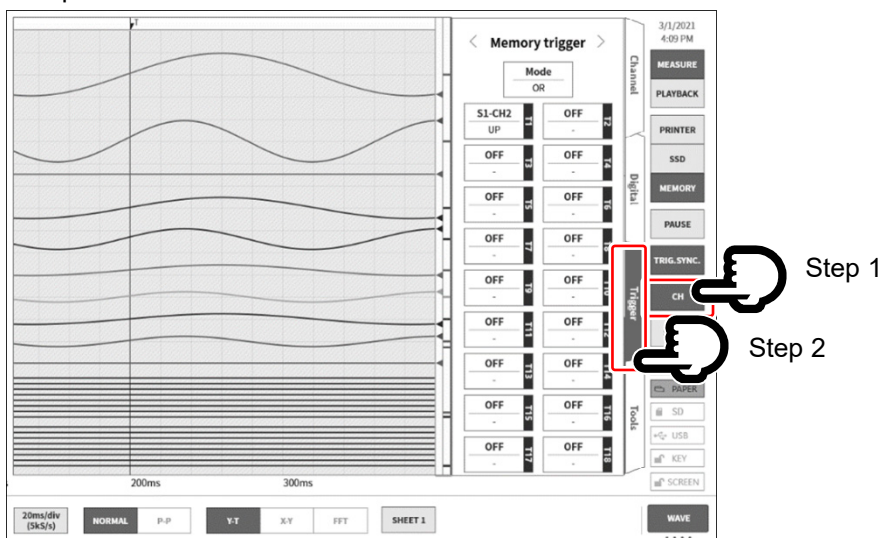

Step 3. Up to 18 trigger sources 【T1】 to 【T18】 can be set.

Tap the number of the trigger source to set to display the details screen.

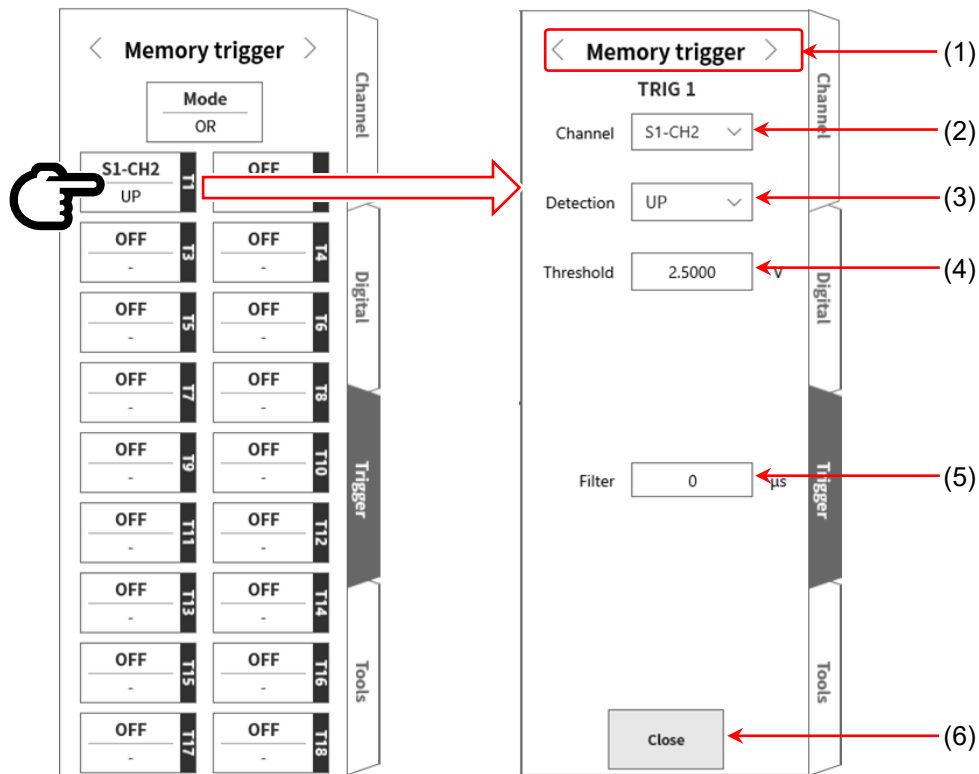

(1) Trigger menu selection:

Switches between the Memory trigger, Start trigger, or Memory block menu

(2) Channel: Selects the TRIGn source channel.

(3) Detection: Selects UP, DOWN, INTO WIN, or OUT WIN for the polarity of the trigger signal.

UP The trigger is detected when the value exceeds the trigger level (threshold).

DOWN The trigger is detected when the value is below the trigger level (threshold).

INTO WIN The trigger is detected when the value enters the range of the upper limit value or lower limit value of the trigger level.

OUT WIN The trigger is detected when the value leaves the range of the upper limit value or lower limit value of the trigger level.

(4) Threshold: Sets the trigger level (threshold).

For INTO WIN / OUT WIN, there are two settings: the upper threshold and lower threshold.

(5) Filter: Sets the filter time for noise removal.

(6) Close: Ends the setting operation and returns to the trigger list.

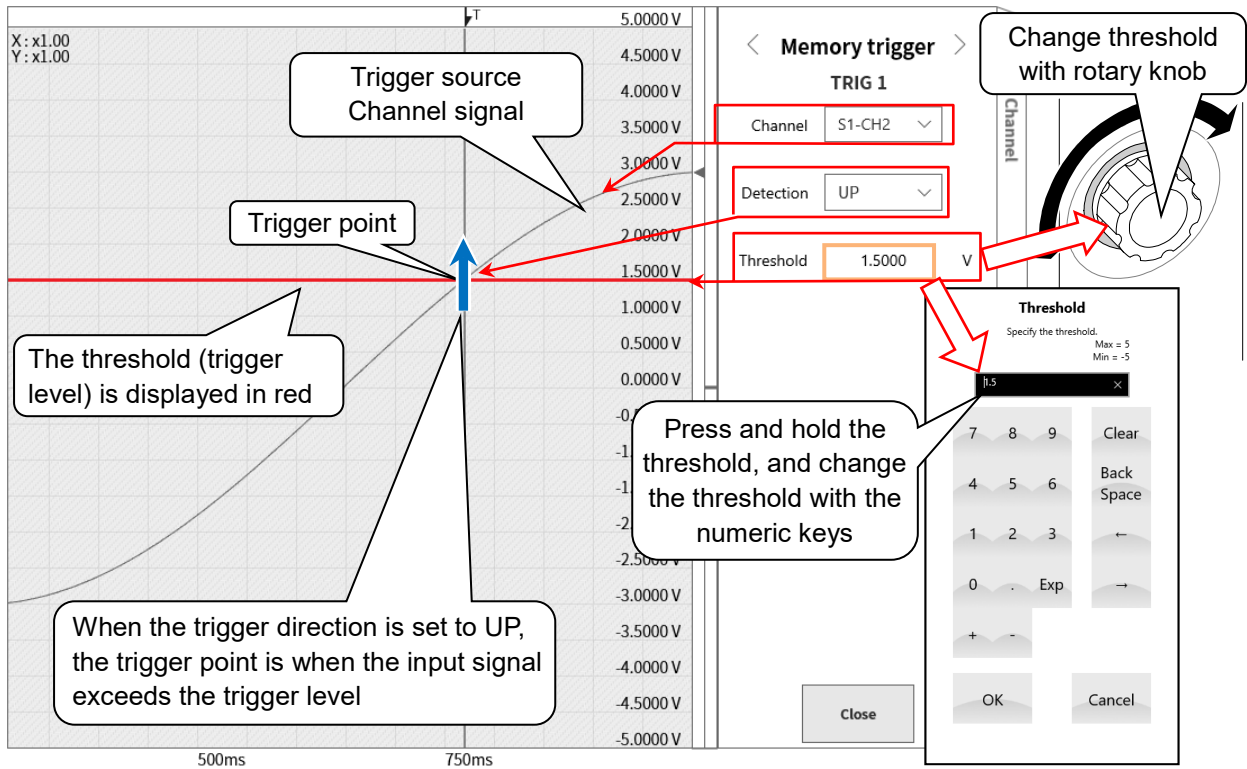

Description of trigger source (3) Detection and (4) Threshold (Settings on page 38)

- When the OR/AND trigger is used: (3) Trigger detection when the UP/DOWN trigger is selected for detection.

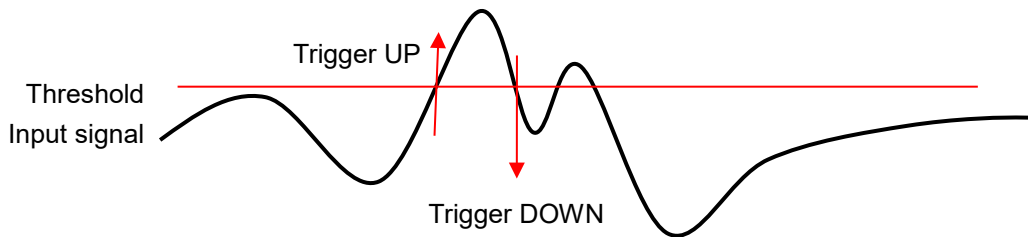

- When the window trigger is used: (3) Trigger detection when the INTO WIN / OUT WIN trigger is selected for detection.

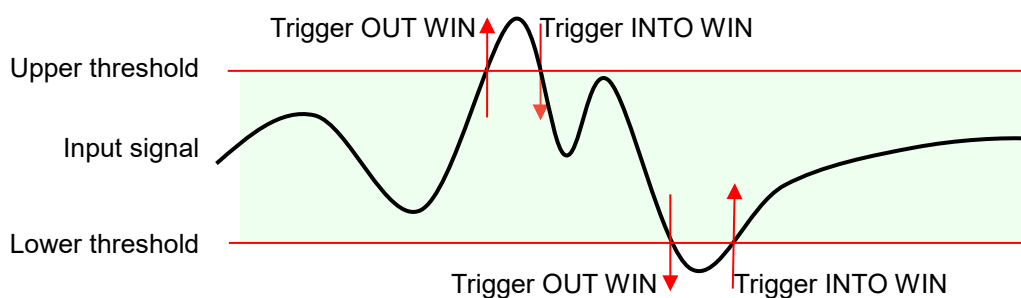

**CAUTION**

- The trigger level is a value relative to the set measurement range. The value also changes when the measurement range is changed.  
 (Example) When the trigger level is set to 10 mV when the range is 100 mV, and then the measurement range is changed to 200 mV, the trigger level is changed to 20 mV.

## Description of trigger source (5) Filter

(Settings on page 38)

□ Trigger filter

The trigger filter function ensures that a trigger is detected when the trigger conditions are met for a specified period of time, in order to prevent erroneous trigger detection due to noise or chattering in the signal near the trigger level.

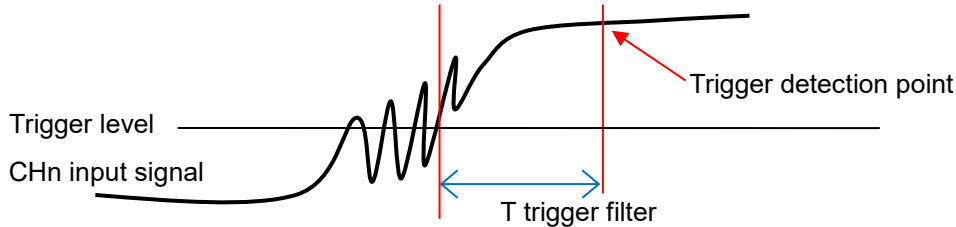

### 5.3. Pre-Trigger

When performing memory recording, a pre-trigger can be set to adjust the recording length before and after the trigger detection point in the memory block.

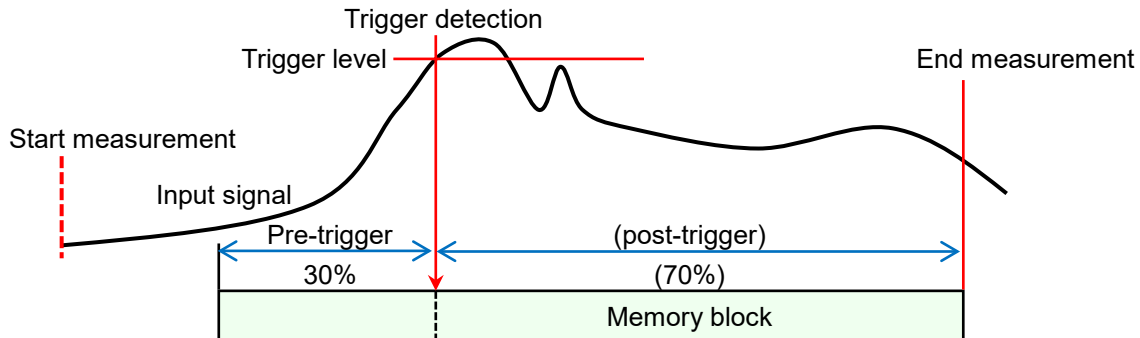

#### 5.3.1. Pre-Trigger Setup

- Tap the **【SETUP】** key on the side menu to display the settings menu.
- Tap the **【Recording】** tab in the recording settings to display the recording setup screen. The recording device settings are displayed below the recording settings.
- Tap **【Pre-Trigger】** on the right of memory recording to set the pre-trigger.

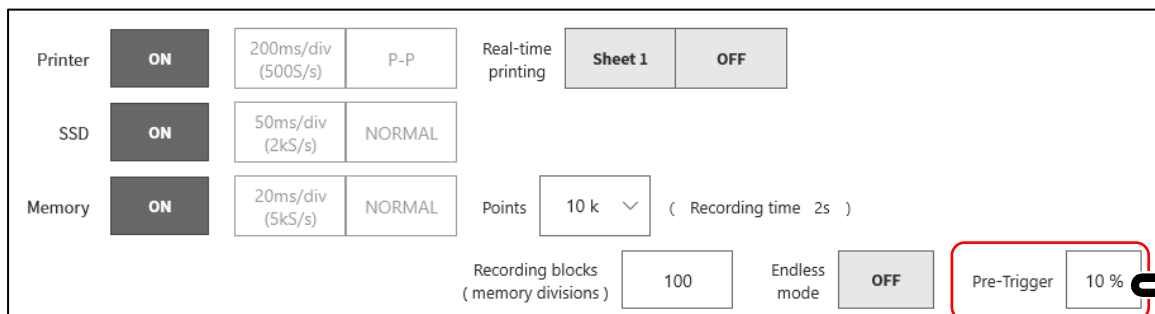



## 5.4. Start Trigger

The start trigger function starts recording when the trigger conditions are established for the channel specified in the trigger source. Press the **START** key on the operation panel to put the product in the standby state.

Printer recording, SSD recording, and memory recording start when the start trigger is detected.

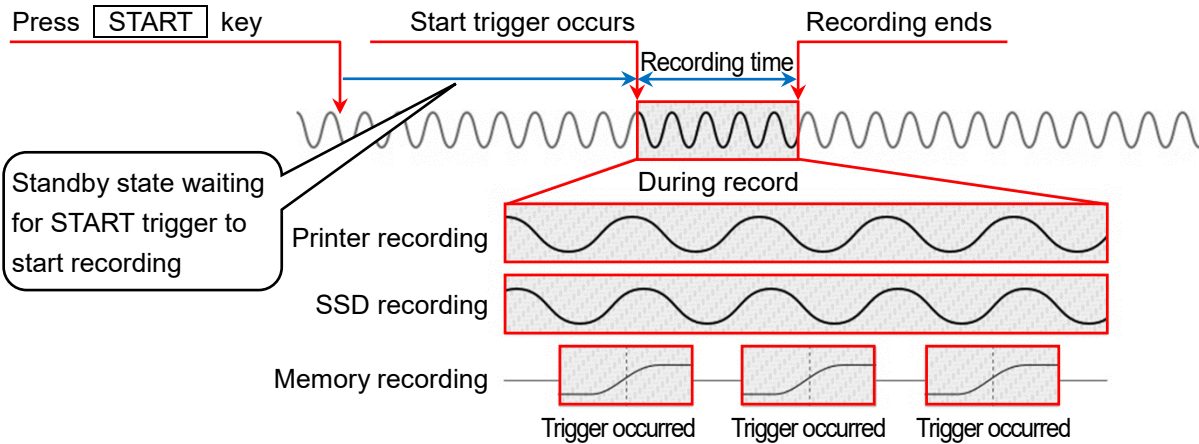

### 5.4.1. Start Trigger Setup

Step 1. Tap the **CH** key on the side menu to display the channel setup sub menu.

Step 2. Tap the **Trigger** tab on the bottom right of the sub menu to display the trigger setup screen.

Step 3. Tap the **trigger menu selection** on the top of the trigger setup screen (1) to display [Start trigger].

(1) Trigger menu selection: Switches the menu.

(2) Channel: Selects the start trigger source channel.

(3) Detection: Selects UP, DOWN, INTO WIN, or OUT WIN for the polarity of the trigger signal.

(4) Threshold: Sets the trigger level (threshold).

(5) Filter: Sets the filter time for noise removal.

The settings and operations of (1) to (5) are the same as the memory trigger on page 38.

# 6. Measuring Input Signals

## 6.1. State Transition of Main Unit Operation

This product is divided into three states according to the operation state: monitor, record, and playback. The **PRINT** key can also be pressed in the monitor display state to perform real-time waveform printing (pen recording) via the internal printer.

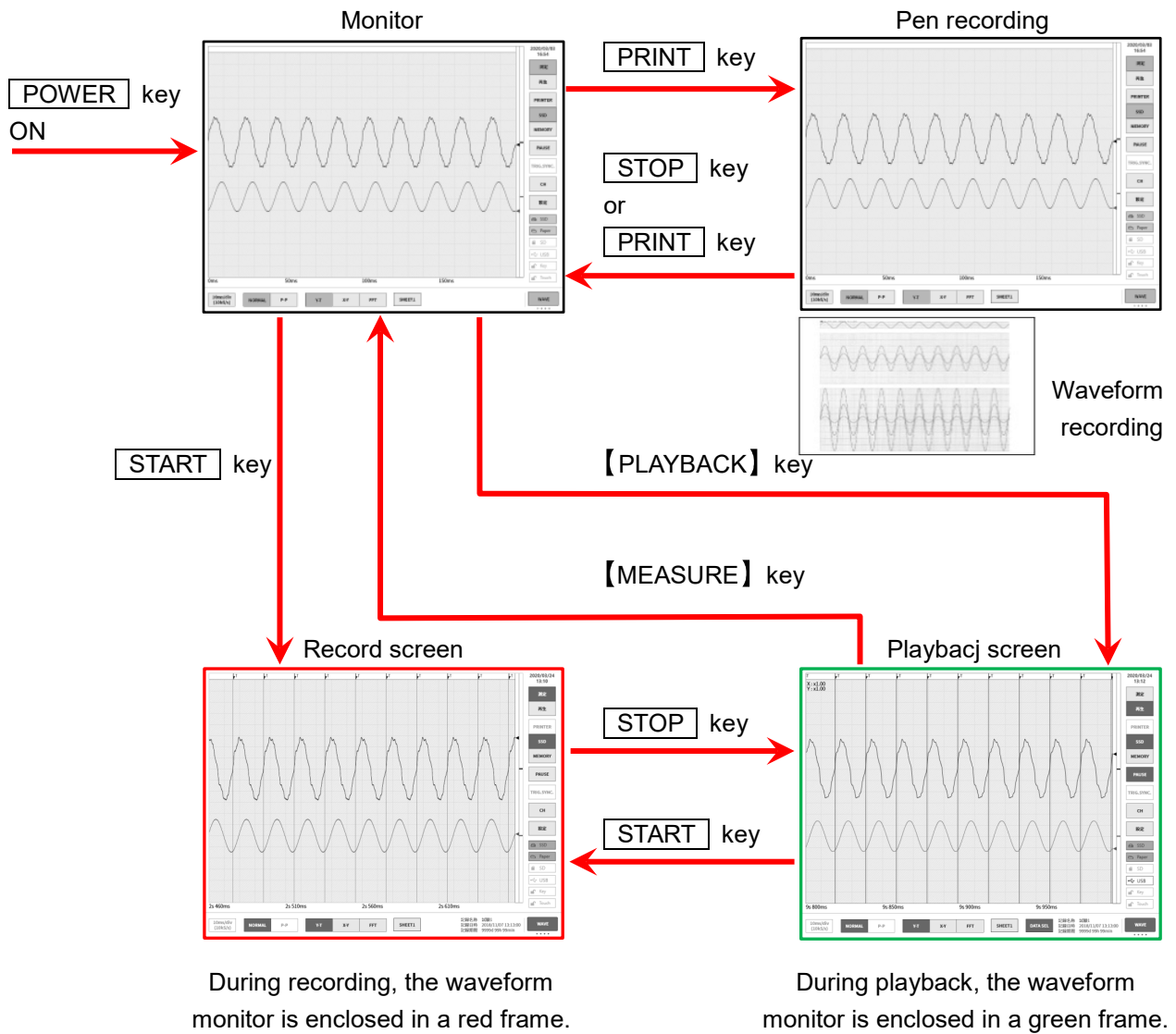

## 6.2. Monitor Display and Pen Recording

### 6.2.1. Monitor Display Function

Tap the recording device selection in the side menu to display the image waveform recorded on the selected device on the waveform monitor.

#### Printer recording

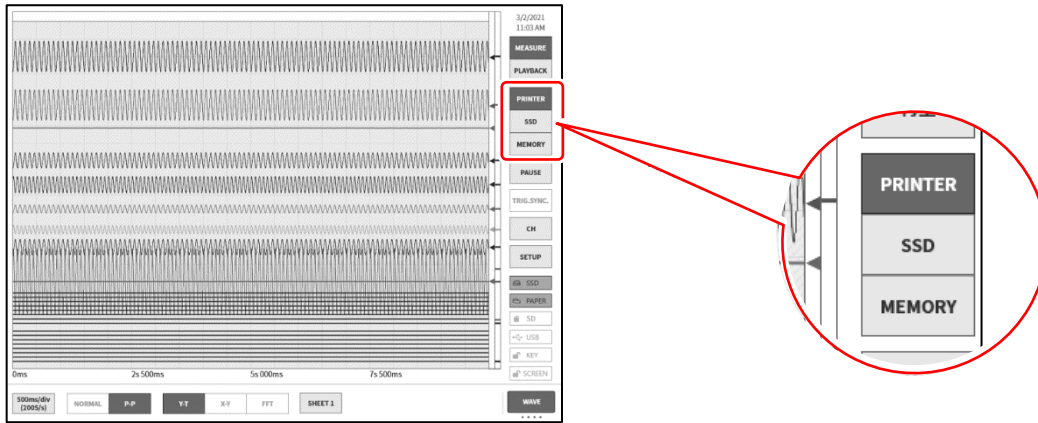

#### SSD recording

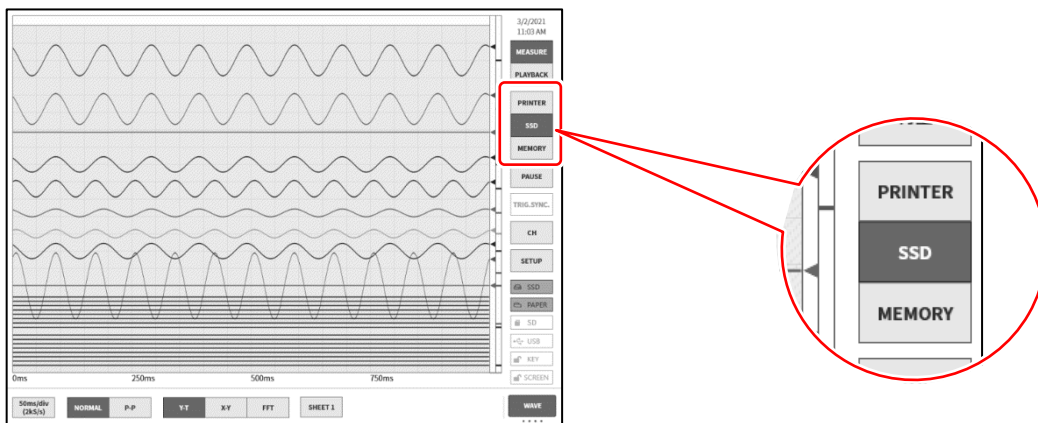

#### Memory recording

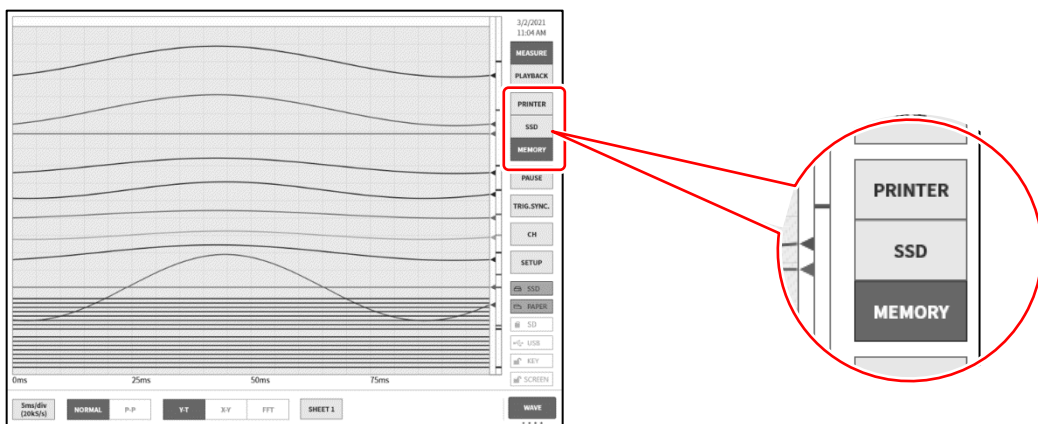

## Pausing

Tap the **【PAUSE】** key on the waveform monitor to stop the monitor.

In this state, you can pinch in (reduce) or pinch out (expand) the waveform on the waveform monitor.

You can also use one finger to drag the screen up, down, left, or right to move the display area.

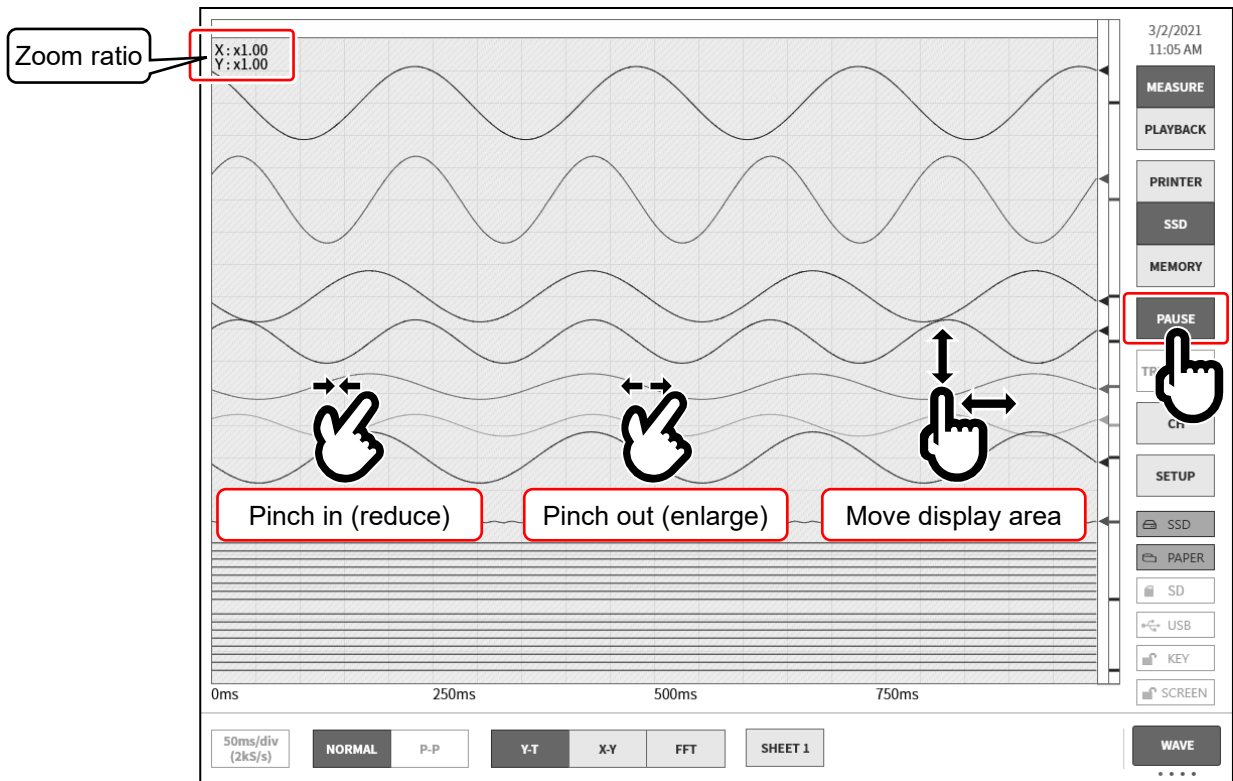

## Sampling Speed

Use the **【Sampling speed】** key on the left edge of the control bar to change the sampling speed according to the recording device. Set the optimal sampling speed while viewing the monitor waveform.

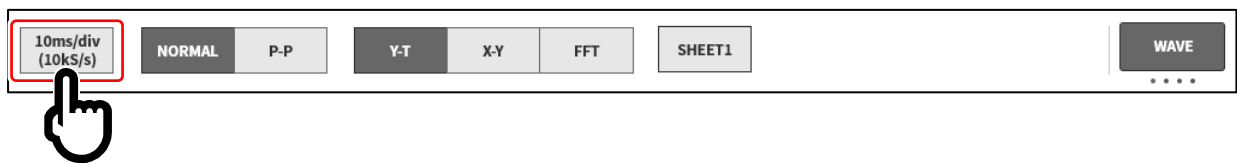

### X-Y Waveform and FFT Analysis

When **【SSD】** is selected as the recording device and **【NORMAL】** is selected as the data format, FFT analysis and the X-Y waveform display for the control bar waveform format are enabled.

#### X-Y waveform conditions

- Recording device: SSD
- Sampling speed: 1 kS/s or lower
- Data format: NORMAL
- Analog input amp: 2 channels or above

◆ X-Y waveform (1 screen)

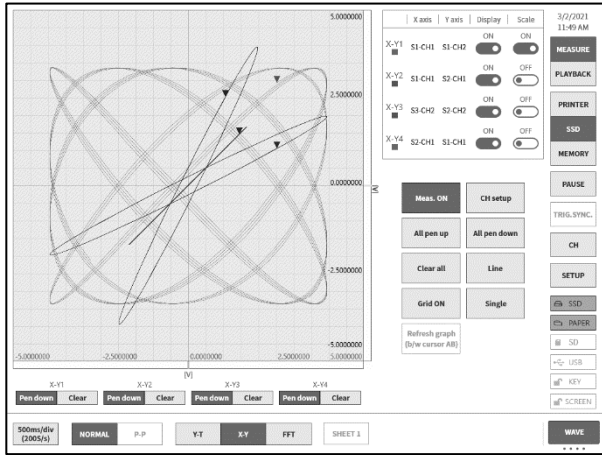

◆ X-Y waveform (4 screen)

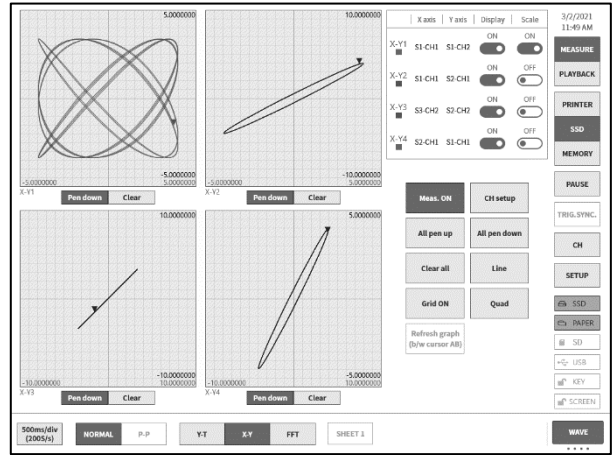

### FFT Analysis

#### FFT analysis conditions

- Recording device: SSD
- Sampling speed: 1 MS/s or lower
- Data format: NORMAL
- Analog input amp: 1 channel or 2 channel

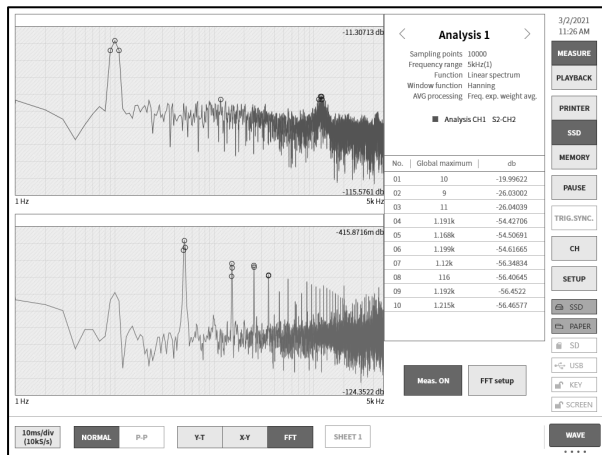

### 6.2.2. Pen Recording

Pen recording enables direct waveform printing to the recording paper without saving the measurement data.

This enables single-touch simple and certain waveform recording like a conventional pen recorder.

#### Pen Recording

Press the **PRINT** key on the operation panel when the waveform format is set to **【Y-T】** to perform real-time waveform printing with the printer block.

The chart speed (sampling speed) and input module settings can be changed while executing pen recording.

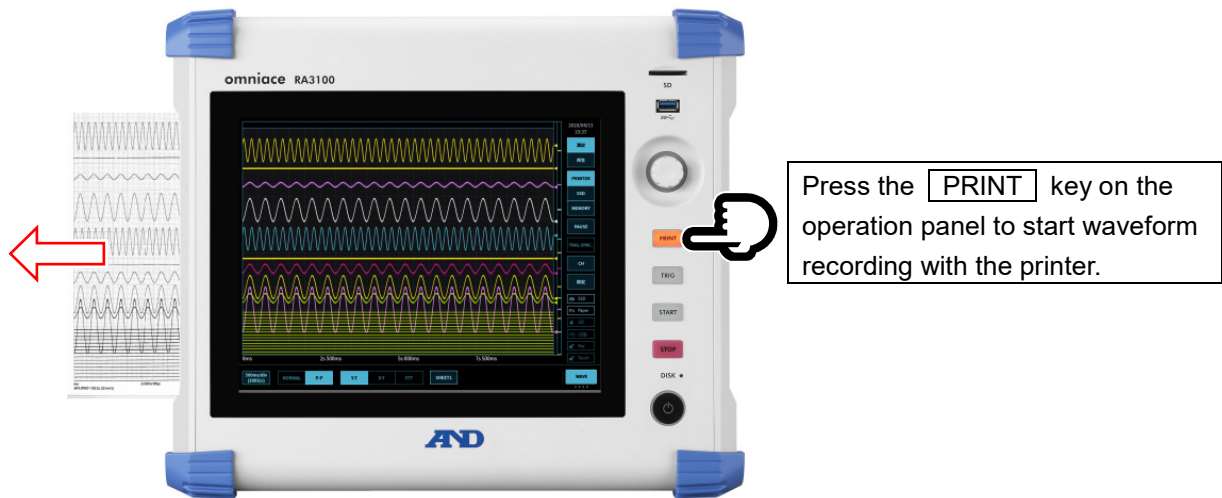

#### Pen Recording Mode

When **【PRINTER】** is selected as the recording device, tap the menu on the right edge of the control bar and select **【PENREC】** to enter the pen recording mode, which enables unique functions for recording to recording paper.

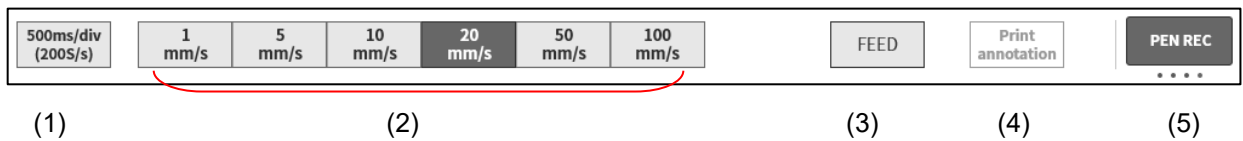

(1) Sampling speed set in **【WAVE】** on the control bar

(2) User defined chart speed (6 speeds):

Frequently used recording speeds can be registered in the preferences to enable single-touch chart speed settings.

(3) FEED: The recording paper is fed (idle feeding) while this is pressed.

(4) Annotation printing: Tap this key during waveform recording to print annotations together with the waveform.

### 6.2.3. Setup and Printing Annotations

This product has a function for printing header, annotation, and footer text before, during, and after waveform recording with the printer.

Tap the **[Annotation printing]** key during waveform recording to print annotations overlaid on the waveform. When CH name printing is enabled, the CH name is printed before printing the waveform.

#### Printing example

Header printing  
Prints a header  
before printing the  
waveform

Prints CH name  
before printing  
the waveform

Prints annotations  
overlaid on the  
waveform

Press the **[STOP]** key or **[PRINT]**  
key to end waveform printing.  
Recording ends after printing the  
footer.

The screenshot displays a multi-channel waveform recording interface. The top header contains the following information:

- Title: Operation Check Test
- Test No.: 0123456
- Test Day: March 3, 2020
- Test Place: Center
- Tester: OmniAce
- Test Contents: xxxxxxxx, yyyyyyyy, zzzzzzzz
- Input Conditions: CH1, CH2, CH3, CH4, CH5, CH6, CH7, CH8, CH9, CH10

The main display area shows multiple channels with waveforms:

- S1-CH1: A Voltage (sinusoidal wave)
- S1-CH2: B Voltage (sinusoidal wave)
- S4-CH1: Temperature (sinusoidal wave)
- S2-CH1, S2-CH2, S2-CH3, S2-CH4: Various waveforms
- S3-CH1, S3-CH2: Various waveforms
- S6-CH1, S6-CH2: Various waveforms

Annotations are overlaid on the waveforms, including the channel names and test details. The bottom of the screen shows "DATA SPEED = 100 S/s (1 s/div)" and a "5s" scale indicator.

## 6.3. Starting and Ending Recording

This product has three recording devices: printer, memory, or SSD. When recording is enabled for a device, the data recorded to each device is recorded to the SSD while it is recorded to the device. For the printer, the waveform data (P-P values) printed to the recording paper are also recorded to the SSD.

For the memory, the memory data is recorded to the SSD when memory recording ends.

### 6.3.1. Recording Setup

Tap **[SETUP]** → **[Recording setup]** on the side menu.

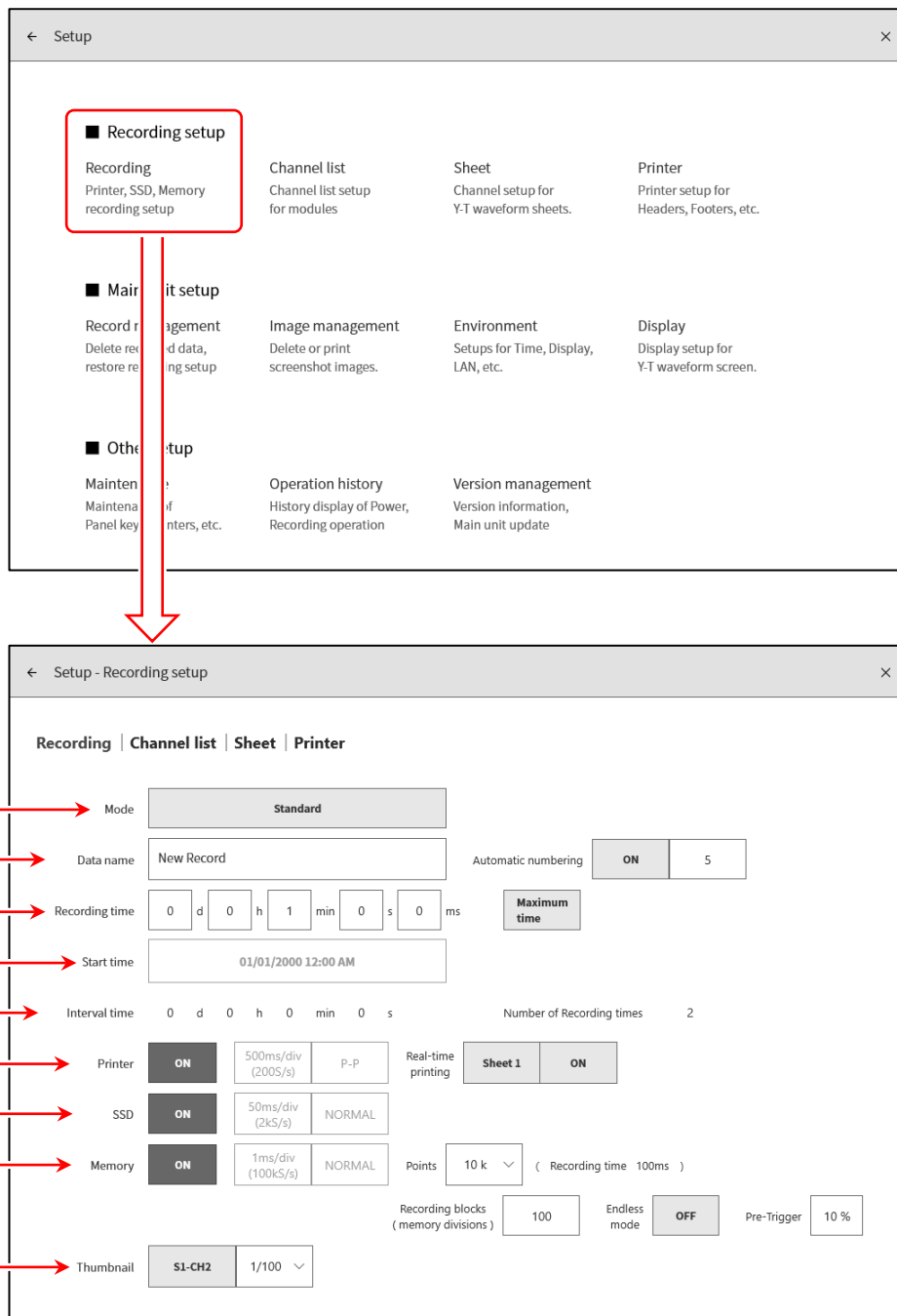



- (1) Mode: Selects the optimal mode from the nine recording modes.
- (2) Data name: Specifies the name of the recorded data.  
When [Automatic numbering] is enabled, numbers are automatically appended to the name.
- (3) Recording time: Ends recording after recording for the specified time after recording starts.
- (4) Start time: Starts recording at the specified time after starting measurement with the  key.
- (5) Interval time: Performs recording at the specified interval. Recording ends when recording has been performed the number of times specified in [Number of Recording times].
- (6) Recording device: Enables/disables recording to the recording device (Printer, SSD, or Memory).  
The devices can be set independently.
- (7) Printer : Enables/disables printer recording.  
When enabled, the P-P data is recorded to the SSD with sampling of printer recording.
- Real-time printing: When printer recording is enabled, real-time printing to the printer can be enabled/disabled.  
When enabled, the waveform of the specified sheet is printed from the printer while saving the data of the printer recording.  
When disabled, printing to the printer is not performed.
- (8) SSD: Enables/disables SSD recording.
- (9) Memory: Enables/disables memory recording.
- Points: Specifies the sampling count (the data count per channel) to record for each memory recording.
- Recording blocks: Specifies the number of blocks to record for memory recording.
- Endless mode: When the endless mode is enabled, the blocks start to be overwritten from the first block when the record blocks are full.
- Pre-trigger: Sets the pre-trigger in the memory block.
- (10) Thumbnail: Specifies the channels to display thumbnails for and the compression rate.

### 6.3.2. Starting and Ending Recording

#### Starting Recording

Press the **START** key on the operation panel to start device recording and enclose the screen with a red frame.



Red frame

#### Ending Recording

Recording ends when the recording time set in **Recording time** elapses or when the **STOP** key on the operation panel is pressed. Then the monitor screen automatically switches to the **PLAYBACK** screen and displays the last recording data.

The screen is enclosed in a green frame on the **PLAYBACK** screen.

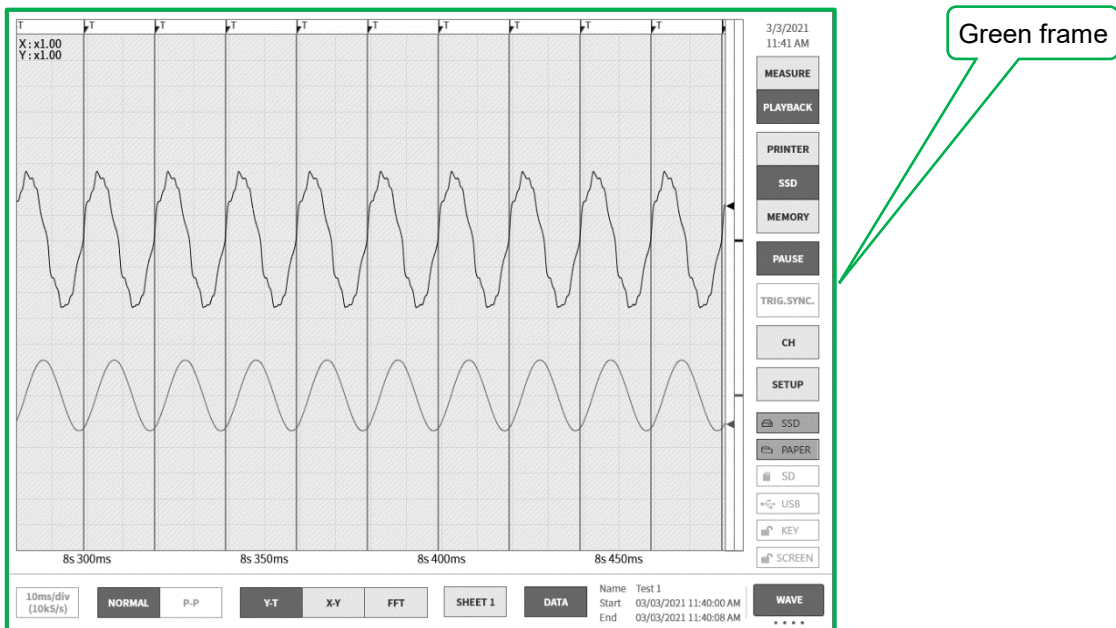

Green frame

When the memory waveform is displayed on the monitor, you can display the **【Trigger】** tab from **【CH】** on the side menu to display [Memory block] for checking the recorded memory data.

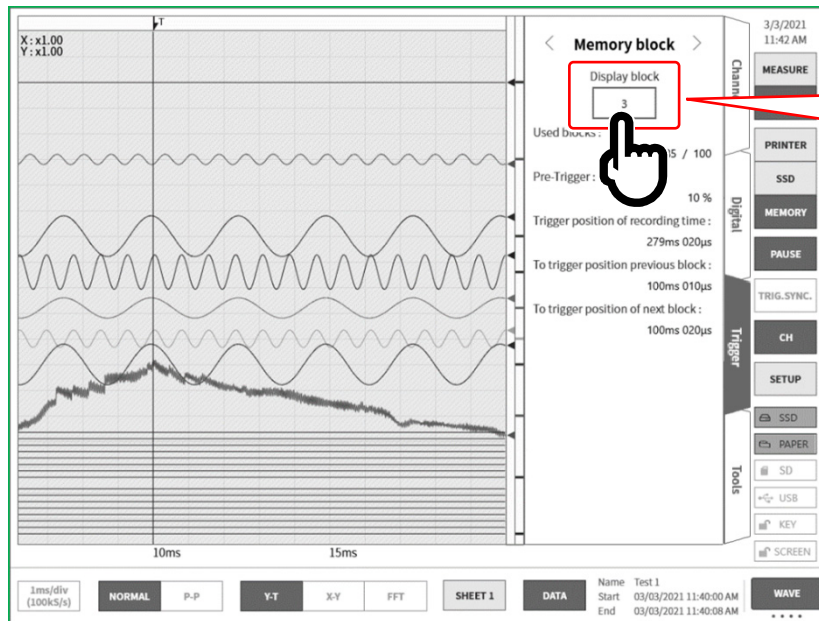

Tap and change the display block number with the rotary knob.

### 6.3.3. Pausing Recording and Scrolling Back

Start recording with the printer recorded or SSD recorded waveform displayed on the waveform monitor. The **【PAUSE】** key can be tapped on the side menu during recording to stop the monitor waveform but continue recording. Since the product is still in the recording state, [MEASURE] is selected on the side menu and the waveform frame remains red. Scroll the waveform monitor to the right in this state to scroll the waveform back and check the past waveform that has already been recorded. Scroll the waveform monitor to the left to display the waveform recorded after pausing. You can also pinch in (reduce)/pinch out (expand) the waveform.

Tap the **【PAUSE】** key again to monitor the waveform with the latest data.

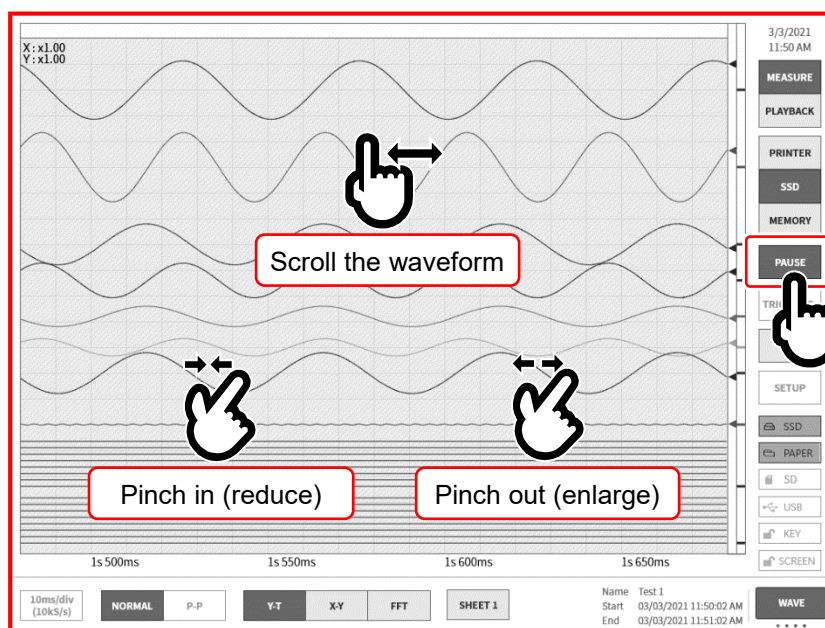

Tap the **【PAUSE】** key to stop the monitor.

## 7. Playback Recorded Data

To playback recorded data, tap **【PLAYBACK】** for **【MEASURE/PLAYBACK】** on the side menu to switch the monitor to the playback screen. The monitor automatically switches to the playback screen when measurement ends.

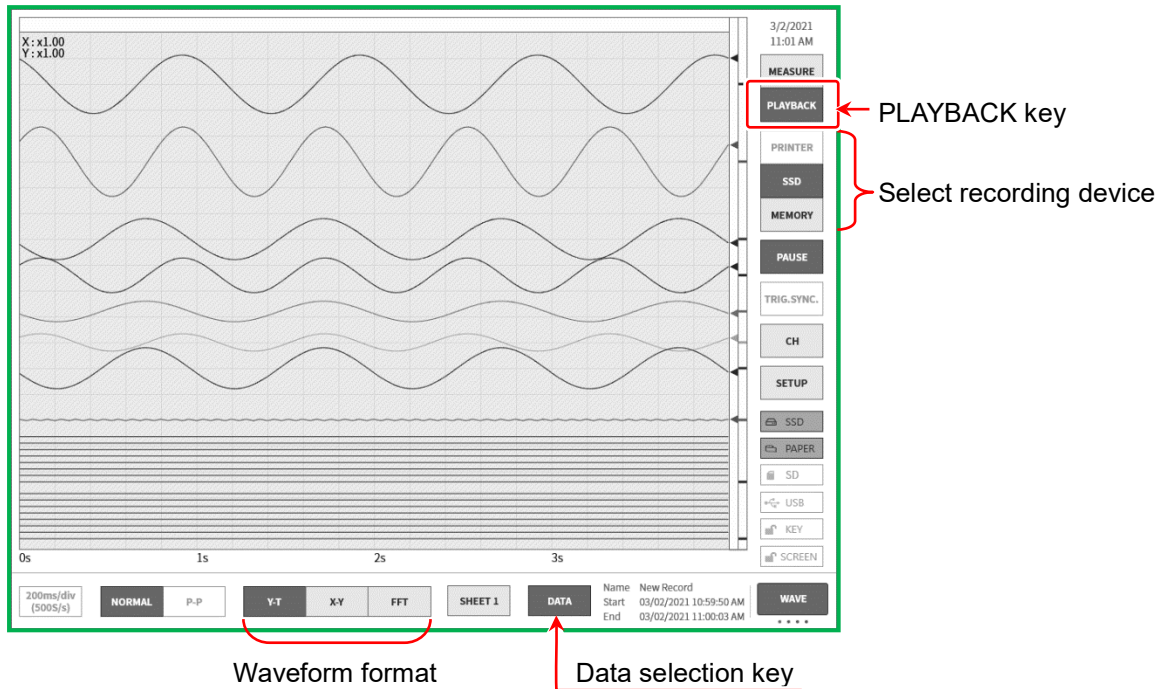

### 7.1. Select Recorded Data

Tap the **【DATA】** selection key on the control bar to display the recorded data list indicated below. Select the data and tap the **【OK】** key to display that waveform.

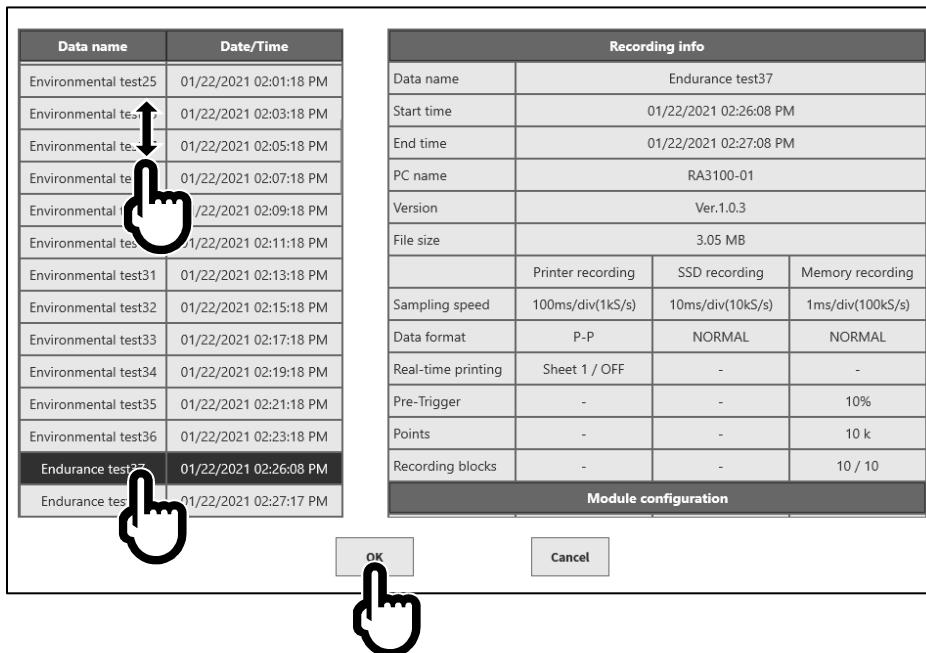

- Data name:** The recording name set in the recording settings. Setting an easy-to-understand name when recording makes it easier to search for the data to playback.
- Date/Time:** The date and time that the data was recorded
- Recording info:** Displays information on the selected recorded data.

## 7.2. Playback Recorded Data

By displaying a waveform in the playback monitor and selecting a device in the side menu, the waveform for each device when recording is displayed.

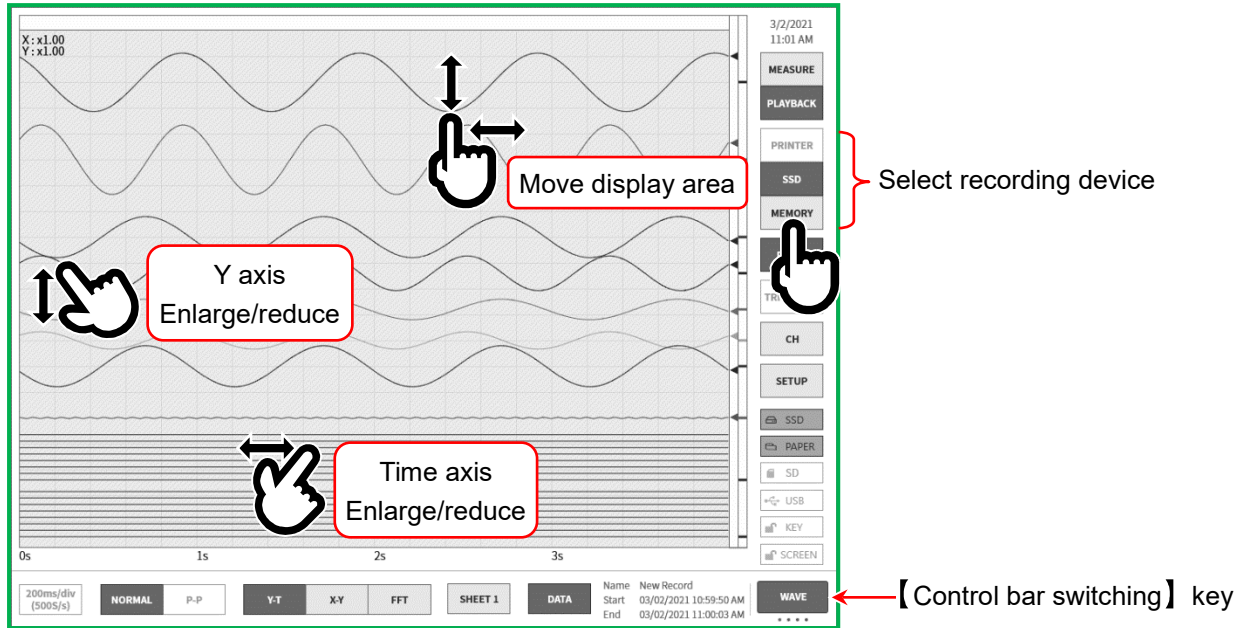

### 7.2.1. Thumbnails

Tap the 【Control bar switching】 key to switch the functions on the control bar in the order 【WAVE】 ⇒ 【THUMBNAIL】 ⇒ 【CURSOR】 ⇒ 【PENREC】 ⇒ 【WAVE】.

Select 【THUMBNAIL】 to display the thumbnail waveform of the channel set in the recording setup menu in the control bar area.

You can also tap the 【thumbnail display channel】 key to select the channel to display.

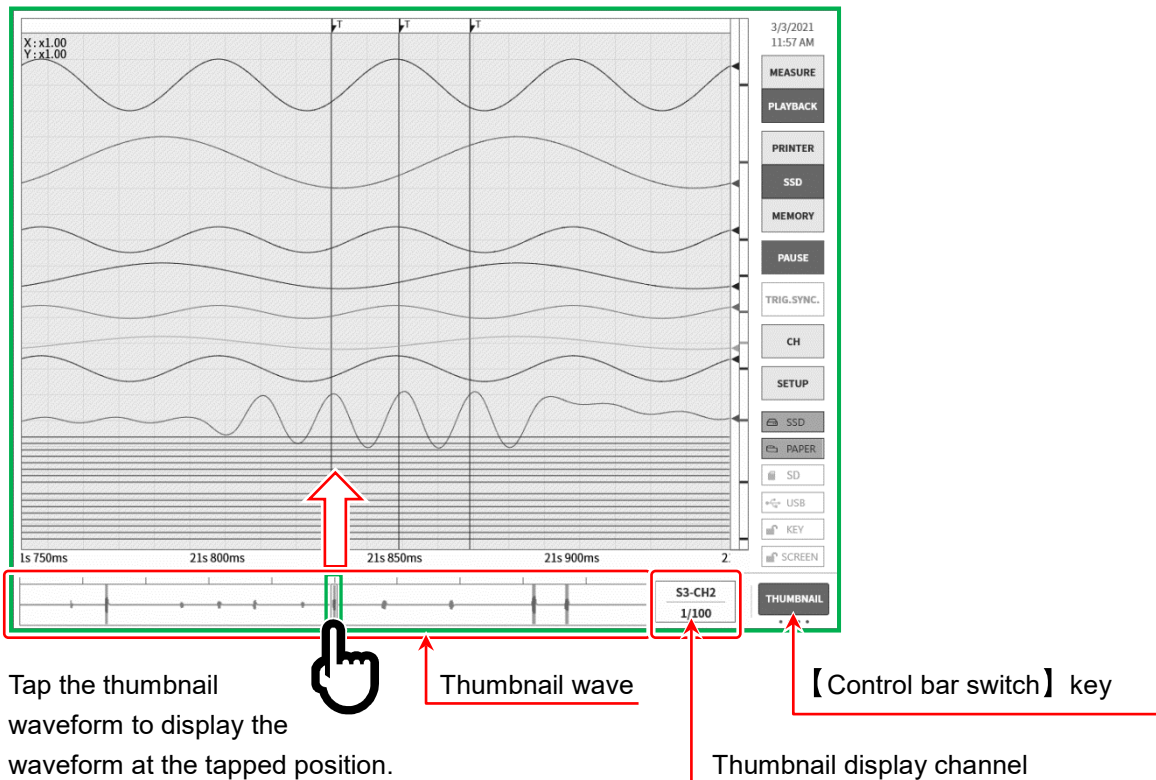

### 7.2.2. Cursors

When **[CURSOR]** is selected for the **[Control bar switching]** on the right edge of the control bar, the A and B time axis cursors are displayed.

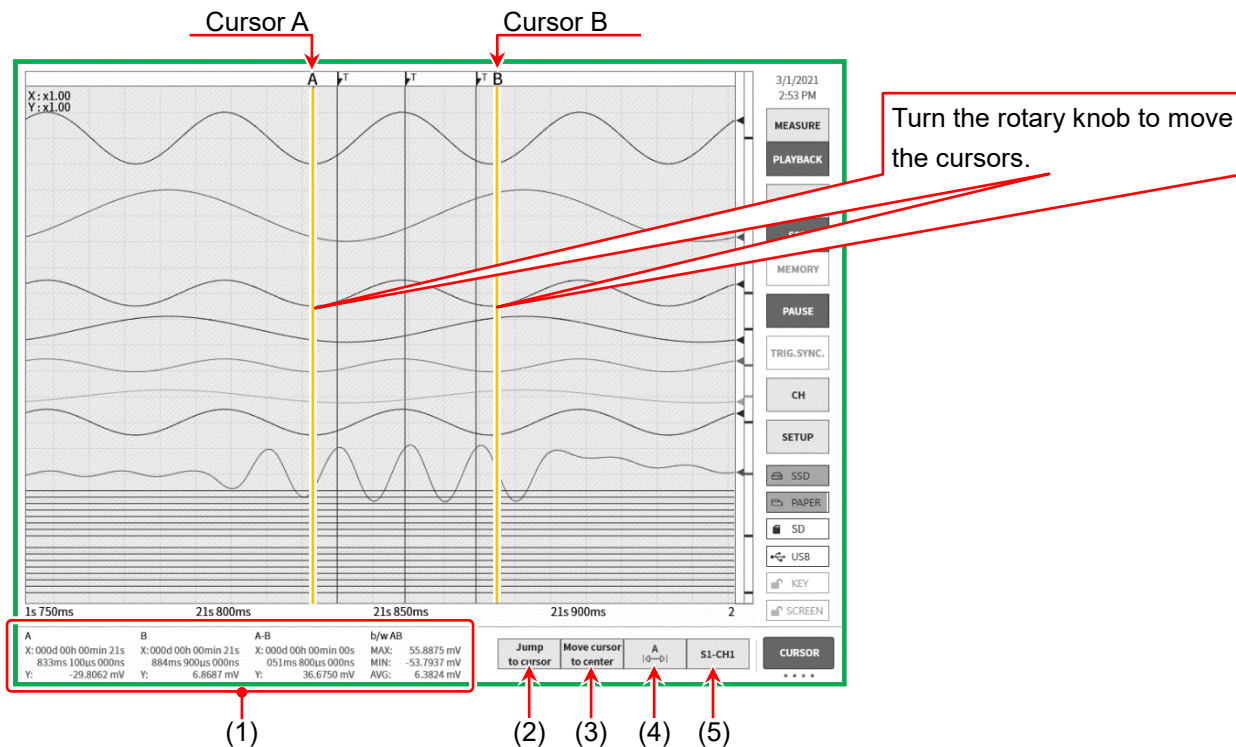

(1) Cursor position data information

- A: Recorded data information of the cursor A position  
X is the time from the first of cursor A, and Y is the data value at the position of cursor A.
- B: Recorded data information of the cursor B position  
X is the time from the first of cursor B, and Y is the data value at the position of cursor B.
- A-B: Information on the difference between cursors A and B  
X is the time between cursors A and B, and Y is the data difference value between cursors A and B.
- b/w AB: The maximum value (MAX), minimum value (MIN), and average value (AVG) between cursors A and B.  
However, this is disabled for printer recorded data because the P-P value is used. It is also disabled when the P-P value is selected for SSD recording.

(2) **[Jump to cursor]** key

Tap the key to move the waveform so that the cursor position is in the monitor center.

(3) **[Move cursor to center]** key

Tap the key to move the specified cursor to the monitor center.

(4) Cursor selection

Select the cursor to change the cursor position for. The cursor changes in the order

**[A] ⇒ [B] ⇒ [A-B]** each tap.

Turn the rotary knob with **[A]** selected to move cursor A.

Turn the rotary knob with **[B]** selected to move cursor B.

Turn the rotary knob with **[A-B]** selected to move with the distance between cursor A and cursor B maintained.

(5) Channel selection

Selects the channel to display in the cursor position information. Tap the **【channel selection】** key to display the channel selection screen indicated below, where you can select the channel to display in the cursor position information.

### 7.2.3. Printing Out

Press the **PRINT** key on the operation panel with the playback monitor displayed to use the printer to print the waveform between cursors A and B on the monitor.

#### **NOTE**

- After reading recorded data, cursor A indicates the start of the data and cursor B indicates the end of the data.  
Even if the time axis or waveform amplitude is enlarged on the monitor, the printer prints the recorded time axis and amplitude set in the channel settings.

### 7.3. Record Management

The method for managing data recorded with this product is explained below.

Tap **[Record management]** in the main unit settings in **[SETUP]** on the side menu to display the **[Record management]** screen.

A list of the recorded data on the internal SSD of the product is displayed on the left side of the **[Record management]** screen.

Tap the Data name or Date/Time in the recording data to display **[Recording info]** for that recorded data on the right.

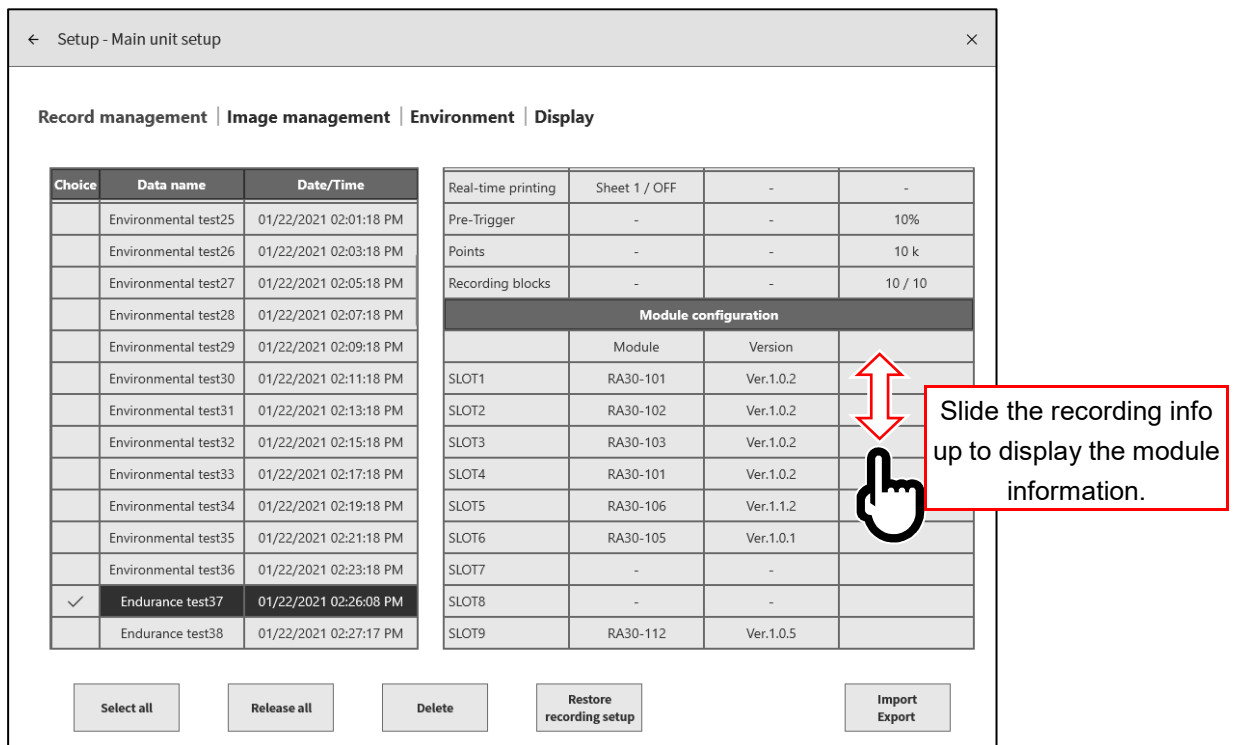
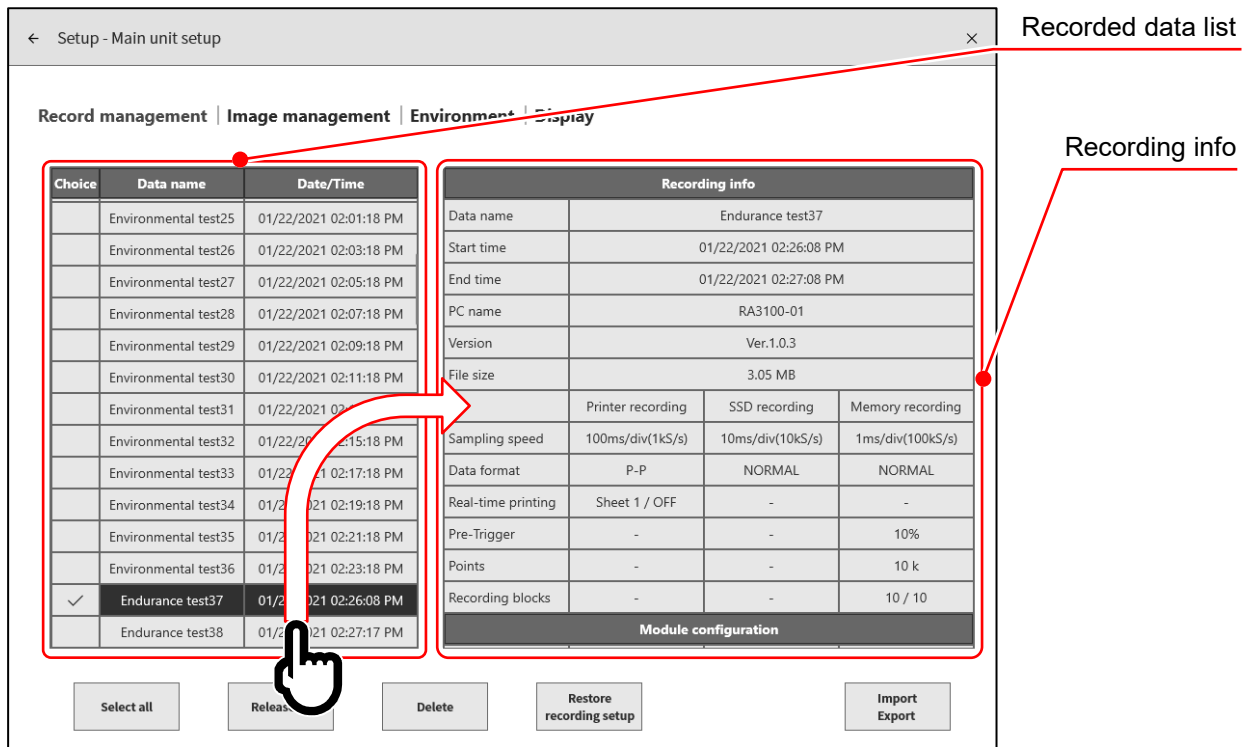



### 7.3.1. Export - Backing Up Recorded Data

Connect the external storage media (such as SD memory card or USB stick) to the main unit and confirm that the SD/USB indicator on the side menu activates.

Tap the **【Import/Export】** key on the bottom right of the **[Record management]** screen to display the external media selection dialog and select the target external media.

Please select SD card or USB.

SD card

OK Cancel

Tap **【OK】** to switch to the **[Import/Export]** screen.

Recorded data list on internal SSD

Recorded data list on external media

Place a check mark (✓) on the data to back up

Choice	Data name	Date/Time
	Environmental test25	01/22/2021 02:01:18 PM
	Environmental test26	01/22/2021 02:03:18 PM
	Environmental test27	01/22/2021 02:05:18 PM
	Environmental test28	01/22/2021 02:07:18 PM
	Environmental test29	01/22/2021 02:09:18 PM
	Environmental test30	01/22/2021 02:11:18 PM
	Environmental test31	01/22/2021 02:13:18 PM
	Environmental test32	01/22/2021 02:15:18 PM
	Environmental test33	01/22/2021 02:17:18 PM
	Environmental test34	01/22/2021 02:19:18 PM
	Environmental test35	01/22/2021 02:21:18 PM
✓	Environmental test36	01/22/2021 02:23:18 PM
✓	Endurance test37	01/22/2021 02:26:08 PM
✓	Endurance test38	01/22/2021 02:27:17 PM

Choice	Data name	Date/Time
	Environmental test25	01/22/2021 02:01:18 PM
	Environmental test26	01/22/2021 02:03:18 PM
	Environmental test27	01/22/2021 02:05:18 PM
	Environmental test28	01/22/2021 02:07:18 PM

Internal storage

SD card

« Import «

» Export »

Select all Release all

Select all Release all

Place a check mark (✓) in the selection field of the data to back up and tap the **【Export】** key in the center to export the recorded data.

### 7.3.2. Import - Reading Backup Data

Open the **[Import/Export]** screen in the same way as when exporting data, and import backup data backed up to external media to the main unit.

When importing, place a check mark (✓) in the recorded data list for external media on the right, and tap the **【Import】** key in the center.

When the same data as the backup exists in the internal storage, a cautionary dialog box is displayed, and you can select the appropriate operation using the **【Overwrite】**, **【Skip】**, or **【Cancel】** key.

Same recorded data exists in this unit.  
Data name Environmental test25  
Date/Time 01/22/2021 02:01:18 PM

Apply the same treatment to all subsequent conflicts

Overwrite Skip Cancel

### 7.3.3. Restoring Recording Settings

The recording settings of this product are saved together with the recorded data.

Select the data for the recording settings to restore/set again on the [Record management] screen, and tap the **【Restore recording settings】** key to set the recording settings to the main unit.

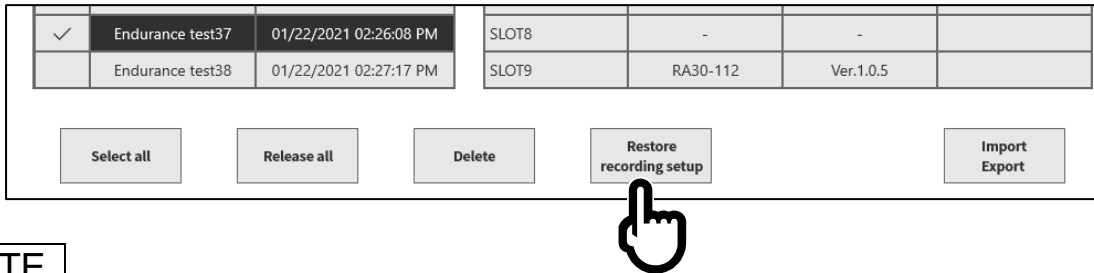

#### NOTE

- Saving the data with the recording settings in the recording name (such as pressing the **START** key then the **STOP** key in a short time) enables the recordings to be easily restored at a later date. The data saved for recording settings can be exported to external media by itself to easily restore recording condition settings.

### 7.3.4. Copying Screens and Exporting to External Media

Press and hold the **PRINT** key on the main unit operation panel to save the displayed screen as image data.

- When the [Screenshot] screen is displayed, use the **【Print】** key, **【Save to internal】** key, or **【Save to external】** key to save the screenshot data.
- (1) Tap the **【Print】** key to print the screenshot image from the printer.
  - (2) Tap the **【Save to internal】** key to save the image data to the SSD of the main unit.
  - (3) Tap the **【Save to external】** key to save the image data to external media (such as an SD memory card or USB stick).

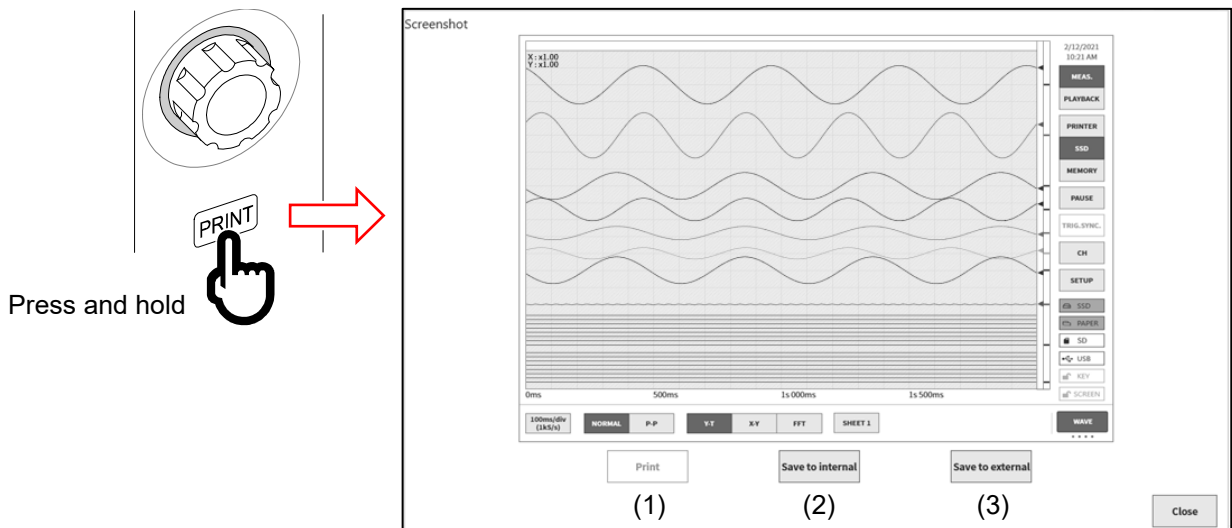

- The image data saved to the main unit is read from [Main unit settings] - [Record management] - [Image management] and can be exported, printed, or deleted with the **【Export】** key, **【Print】** key, or **【Delete】** key.

Tap the list on the left to display a preview of the image on the right.

Tap the selection field of the target image to place a check mark (✓), and press the **【Print】** key, **【Export】** key, or **【Delete】** key to execute the desired operation.

Setup - Main unit setup

Record management | Image management | Environment | Display

Choice	Date/Time
	01/22/2021 03:27:36 PM
	01/22/2021 03:29:15 PM
	01/22/2021 03:29:28 PM

Image list

Preview

Select all Release all Delete Print Export

## 8. Specifications

### 8.1. General Specifications

#### 8.1.1. Main Unit Basic Specifications

Item	Specifications		
Input block	Number of module slots	9 slots	
	Analog input	Maximum 36 channels	
	Logic input	Maximum 144 channels	
Recording device	Internal SSD	256 GB	
	Internal memory	4 GB	
	Internal printer	216 mm thermal printer	
Recording function	SSD recording	Directly recording to internal SSD	
	Memory recording	Recording high-speed phenomena to memory	
	Printer recording	Directly recording input signals to printer	
Sampling Speed	SSD recording	1 MS/s	to 10 S/min
	Memory recording	20 MS/s	to 10 S/min
	Printer recording	1 kS/s (100 mm/s)	to 10 S/min (1 mm/min)
Sampling accuracy	±10 ppm (max)	At all available temperature ranges	
Printer block	Thermal printer		
	Recording width	216 mm	
	Recording speed	100 mm/s to 1 mm/min	1, 2, 5 series
	Chart speed	Within ±2 % (25 °C, 65 % RH)	
	Recording paper	219 mm x 30 m	Paper roll (YPS-106, YPS-108)
		219 mm x 200 m	Z-fold paper (YPS-112)
Display block	12.1" XGA TFT color LCD (1024 x 768 dots)		
	With electrostatic capacitive touch panel (supporting two point multi-touch)		
Operation panel	Operation panel keys	POWER	Power on/off
		START	Start recording
		STOP	Stop recording
		TRIG	Forced trigger
		PRINT	Start printer recording/screen copy
	Rotary knob	Change measurement range or waveform position, etc.	
	Lock function	Key lock	Operation panel key lock
Screen lock		Touch panel key lock	
Interfaces	LAN, USB, SD, COM, DVI-D		
	For details, see " <a href="#">8.2.10. Interface Specifications</a> ".		

## 8.1.2. General Specifications

Item	Specifications		
Power	Rated power voltage	AC 100 to 240 V	
	Allowed range of variation in power voltage	AC 90 to 264 V	
	Rated power frequency	50/60 Hz	
	Allowed range of variation in power frequency	47 to 63 Hz	
	Withstand voltage	Between power and case	1500 V AC for 1 minute
	Insulation resistance	Between power and case	100 MΩ or more at 500 V DC
	Power consumption	For printer recording	300 VA (maximum printing state)
		When recording is stopped	80 VA
		For standby	5 VA (power cord connected and power off)
		Power fuse	Internal (not replaceable)
Locations for use	Indoor, Pollution Degree 2 *1, elevation 2000 m or lower		
Warmup time	60 minutes or longer		
Operating environment	Temperature	0 to 40°C	
	humidity	35 to 85 RH% or less (without condensation)	
Storage environment	Temperature	-20 to 60°C	
	humidity	20 to 85 RH% or less (without condensation)	
Vibration resistance	Sine wave vibration		
	Vibration frequency	10 to 55 Hz	
	Vibration level	20.0 m/s <sup>2</sup> , 3 axis, 20 cycles each	
	Random vibration		
	Vibration frequency	5 to 500 Hz	
	Acceleration rms value	X, Y axis 6.5 m/s <sup>2</sup> , Z axis 10.2 m/s <sup>2</sup> , 1 hour each	
Backup battery life	Approx. 10 years (ambient temperature 23°C), for clock backup		
Standards	Safety standards	EN61010-1	Overvoltage Category II (CAT II) *2
		EN61010-2-30	Measurement Category *3 Dependent on specifications of installed modules
	EMC	EN61326-1, class A	
Dimensions	Approx. 394 mm (W) x 334 mm (H) x 199 mm (D) *Excluding protrusions		
Mass	9.5 kg or less (main unit only)		
Warranty period	1 year		

\*1 The Pollution Degree indicates the level of pollution that can exist in the ambient environment.

Pollution degree 1: No pollution or only dry, non-conductive pollution occurs. The pollution has no influence.

Pollution degree 2: Only non-conductive pollution occurs except that occasionally a temporary conductivity caused by condensation is to be expected.

Pollution degree 3: Conductive pollution occurs, or dry, non-conductive pollution occurs which becomes conductive due to condensation which is to be expected.

Pollution degree 4: The pollution generates persistent conductivity caused by conductive dust or by rain or snow.

\*2 The Overvoltage Category (Installation Category) indicates how much overvoltage (impulse voltage) from an AC power supply an electrical device can withstand. Overvoltage Category II (CAT II) is suitable for devices powered by wire from the switchboard of a building.

\*3 The Measurement Category categorizes a testing or measurement circuit according to the type of main power circuit intended to be connected for testing or measurement, and differs according to the modules installed to this product. Use the product within the Measurement Category that meets the module specifications.

CAT II: Applies to testing and measurement circuits directly connected to the point of use (power outlet or similar location) of a low voltage main power supply system.

CAT III: Applies to testing and measurement circuits connected to the switchboard of the low voltage main power supply system in a building.

CAT IV: Applies to testing and measurement circuits connected to the source of the low voltage main power supply system in a building.

No category (O): Applies to circuits not directly connected to a main power supply.

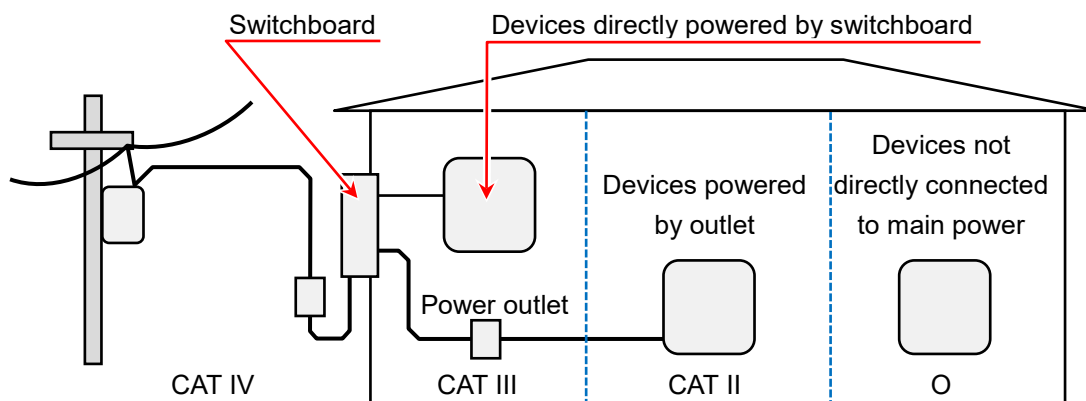

O : Other circuits not directly connected to main power

CAT II : Measurement Category II

CAT III : Measurement Category III

CAT IV : Measurement Category IV

## 8.2. Functional Specifications

### 8.2.1. Measurement Function

Item	Specifications	
Recording mode	The recording modes are indicated below. (1) Standard (2) Start time (3) Start trigger (4) Interval (N times) (5) Start time + Start trigger (6) Start trigger + Interval (N times) (7) Start time + Interval (N times) (8) Start time + Start trigger + Interval (N times) (9) Window recording	
Recording device	Recording to SSD, memory, or printer, and recording to various recording devices at the same time	
Display format	Y-T waveform	Y-T waveform with amplitude on vertical axis and time on horizontal axis
	X-Y waveform	Up to four sets of X-Y waveforms with a user-defined analog input channel specified for the X axis (horizontal) and Y axis (vertical).
	FFT waveform	FFT analysis waveform with maximum two channels
	Digital data	Displays data with numeric values
Sampling speed	Differs according to recording device.	
Maximum recording time	100 days	

## 8.2.2. SSD Recording

Item	Specifications	
Function	Records input data directly to the internal SSD.	
Recording device	Internal SSD	256 GB
Number of channels	Analog	36 ch (max)
	Logic	144 ch (max)
Data format	NORMAL data	Samples and records data at the set sampling speed.
	P-P data	Records the two peak values (max/min) of the data within the set sampling speed period sampled at 20 MS/s.
Sampling Speed	1 MS/s to 10 S/min	500 kS/s(max) for P-P data The speed can be set to 1, 2, or 5 series
	External synchronization sampling *1	Synchronization clock: 250 kHz or less
Information data	Records information related to the recorded data, such as the version of the product, module configuration, channel settings, data format, and recording time.	
Recorded data	Records input data, memory recording start data, and event data (trigger information, marks).	
Window recording	Records the last data specified at the recording time when recording stops. Cannot be used in conjunction with memory recording or printer recording.	
Playback processing	Y-T waveform	Display position changes via swiping and pinch in/pinch out operations to enlarge/reduce.
	FFT Analysis	When the recorded data is NORMAL, FFT analysis function processing is possible.
	X-Y waveform	When the recorded data is NORMAL, X-Y processing is possible, sampling 1 kS/s or below.

\*1 Available when the optional remote control module is installed.



### 8.2.3. Memory Recording

Item	Specifications	
Function	Records to the internal memory with high-speed sampling.	
Recording device	Internal memory	2 GW *1
	Record blocks (number of memory divisions)	Divided into 1 to 200 user-defined blocks
	Points	The number of data items per channel that can be recorded to a recording block 2 kW to 2 GW (selected in step 1-2-5)
Channels x points x blocks ≤ 2 GW		
Number of channels	Analog	36 ch (max), 18 ch at 20 MS/s
	Logic	144 ch (max)
Data format	NORMAL data	
Sampling speed	20 MS/s to 10 S/min	The speed can be set to 1, 2, or 5 series
Information data	Records information related to the recorded data, such as the version of the product, module configuration, channel settings, data format, and recording time.	
Recorded data	Records input data and trigger information.	
Playback processing	Y-T waveform	Display position changes via swiping and pinch in/pinch out operations to enlarge/reduce.

\*1 W(word) refers to a unit of data. 1 W = 2 bytes

### 8.2.4. Printer Recording

Item	Specifications		
Function	Directly records the input signal to the printer as a waveform.		
Recording drive	Internal printer	Thermal printer	
Number of printer recording channels	144 ch	The total analog and logical channels that can record to the SSD simultaneously	
	48 ch	The total number of analog and logical channels that can record to recording paper simultaneously, channel for printing to recording paper can be selected with sheet settings, and all channels can be printed with the playback function	
Data format	P-P data		
Recording speed	100 mm/s to 1 mm/min	1, 2, or 5 series,	
External synchronization*1	50 mm/s (500 Hz) max for external synchronization		
Recording resolution	Waveform amplitude direction	8 dots/mm	
	Time axis direction	100 S/div	
	Printing resolution	20 dots/mm	100 mm/s
		40 dots/mm	50 mm/s, external synchronization*1
	80 dots/mm	25 mm/s or less	

\*1 Available when the optional remote control module is installed.

## 8.2.5. Trigger Function

### [Basic trigger function]

Item	Specifications	
Trigger function	Start trigger	Start trigger for recording operation
	Memory trigger	Trigger for memory recording
Trigger type	Analog input signal *2	
	Level trigger	Trigger when an analog signal transects (rises above/falls below) the set threshold
	Window trigger	INTO WIN: Trigger when the analog signal enters the upper/lower limit range OUT WIN: Trigger when the analog signal leaves the upper/lower limit range
	Logic input signal *2	Logic signal bit pattern judgment trigger
	Bit pattern trigger	
	Forced trigger	When the trigger key of the operation panel is pressed
External trigger *1	When the external trigger input signal becomes active *1	
Trigger filter	This function generates a trigger if the trigger conditions continue to be established for the specified period of time (to ensure that a trigger is not generated by noise, etc.)	
	Filter time	0 to 100 s

\*1 Available when the optional remote control module is installed.

\*2 Analog input and logical input triggers (triggers from input channels) are collectively referred to as channel triggers.

### [Start trigger]

Item	Specifications
Trigger source	Channel trigger, forced trigger, external trigger
Channel trigger specified number of channels	1ch

### [Memory trigger]

Item	Specifications
Trigger source	Channel trigger, forced trigger, external trigger
Channel trigger specified number of channels	18 channel AND/OR setting available

## 8.2.6. Monitor Function

Item	Specifications		
Display screen	MEASURE	Displays the state waveform of the input signal	
	PLAYBACK	Playback the memory, SSD, or printer recorded data	
Waveform type	Y-T waveform, X-Y waveform, FFT waveform		
	Enables waveform display for an arbitrary analog signal and logic signal		
	Y-T waveform	Enables 48 channel/sheet signal display	
	X-Y waveform	Enables a maximum of four X-Y waveform sets to be displayed	
	FFT waveform	Enables FFT analysis results to be displayed for a maximum of two channels	
Y-T waveform display			
Display width	20 div x 20 div		
	Time axis (T axis)	1 div = 100 samples	
	Amplitude axis (Y axis)	1 div = 1/10 RANGE (with display range at 100%)	
	Display area	Specifies the display position, display range, display maximum, and display minimum	
Sheet	Enables waveform screens to be managed as three waveform screens (display channel sets)		
Display functions	Numeric value display	Numeric value display of input signal	
	Scale	Scale display of amplitude axis	
	Grid	Grid display of waveform area	
	Trigger/mark	Displays detected trigger/mark	
	Cursor	Displays two cursors	
		Displays the signal information (position and value) of the cursors, information on the differences between cursors, maximums, minimums, and averages	
		Pen position	Displays the signal amplitude position
	Zero position	Displays the signal zero position	
Time display	Displays the time on the bottom of the display area		
Pinch in/out	Enlarges/reduces the display waveform		
TRIG.SYNC	Updates the waveform display screen when the trigger conditions are established		

## 8.2.7. X-Y Waveform

Item	Specifications	
Data selection	SSD recorded data	Data format: Normal data
X-Y axis	X axis channel:	User-defined analog channel
	Y axis channel:	User-defined analog channel
	Four waveforms can be set	
Sampling speed	1 kS/s (max)	
Display format	Select single screen or quad screen	
	Single	Displays four sets of X-Y waveforms on a single screen
	Quad	Displays a separate X-Y waveform on each of four screens

## 8.Specifications -8.2.Functional Specifications

Item	Specifications	
Pen up	Pauses measurement	The pen up operation can be performed for one waveform at a time or all waveforms at once
Pen down	Resumes measurement	The pen down operation can be performed for one waveform at a time or all waveforms at once
Clear	Clears the displayed waveform	The clear operation can be performed for one waveform at a time or all waveforms at once
Refresh graph	Redraws the X-Y waveform between cursors A and B on the Y-T waveform display monitor.	
Display functions	Dot/line	Renders the X-Y waveform with dots or lines
	Scale	Input signal scale display of X axis and Y axis
	Grid	Grid display of waveform area
	Pen position	Displays the input signal position
	Zero position	Displays the signal zero position
	Pinch in/out	Enlarges/reduces the waveform

### 8.2.8. FFT Analysis

Item	Specifications	
Data selection	SSD recorded data	Data format: NORMAL data
Sampling points	Set the analysis sampling points: Select 1000, 2000, 5000, or 10000 points	
Frequency range	500 kHz (max), the frequency range is calculated as 1 or 2 x the sampling speed	
Analysis range selection	Selects the analysis range using two cursors.	
Window function	Supports amplitude gain using a window function. Hanning, hamming, rectangular	
Analysis function	Time scale waveform, linear spectrum, RMS spectrum, power spectrum, power spectrum density, 1/1 octave analysis, 1/3 octave analysis, cross power spectrum, transfer function, coherence function	
Analysis count	2	
Display format	One screen/two screen	
X axis scale	Time, linear frequency, log frequency, 1/1 octave, 1/3 octave	
Y axis scale	Amplitude, linear real part, linear imaginary part, linear amplitude, log amplitude, phase	
Manual scale	Manually sets the X axis and Y axis display area	
Averaging	Time simple averaging, frequency simple averaging, frequency exponential weight averaging, frequency axis peak hold, None	
Average number of additions	1 to 10	
Peak value display	Identifies a maximum of 10 local maximums or global maximums from the analysis results.	
Cursor	Displays two cursors for each analysis and displays the X value and Y value of each cursor.	
Pinch in/out	Enlarges/reduces the FFT analysis results with pinch in/pinch out operations.	

## 8.2.9. Setup / Record Management

Item	Specifications
Recording Setup	
Recording	<p>Mode: Nine type recording mode display and selection.</p> <p>Data name: Recording name, automatic numbering.</p> <p>Recording time: Recording time setting for one time, maximum time settable from remaining SSD capacity.</p> <p>Start time: Set the recording start time</p> <p>Interval time: Set the Interval time and number of recordings</p> <p>Printer: Enable/disable printer recording when performing measurement, sheet selection, enable/disable real-time waveform printing during measurement.</p> <p>SSD: Enable/disable SSD recording when performing measurement.</p> <p>Memory: Enable/disable memory recording when performing measurement, record blocks, points, endless mode, pre-trigger settings.</p> <p>Thumbnails: Sets the channels to displayed in the thumbnails on the monitor and the compression ratio for the display from 1/10 to 1/100.</p>
Channel List	<p>Common: Displays and configures a list of common Setup set in modules and the input module installed in this product.</p> <p>Display items: Channel number, module type.</p> <p>Display items and settings: Channel name, measurement, sheet, color, display position, display range, display maximum, and display minimum.</p> <p>Conversion: List of physical conversion for the installed analog input module.</p> <p>Display items and settings: Conversion method (2-pt /gain), conversion value (conversion 1, conversion 2), unit.</p> <p>List by input module type:</p> <p>Displays and configures a list of the settings unique to each module. Each item can be configured individually or together.</p>
Sheet	List of registered channels and channel registration to sheets 1 to 3
Printer	<p>Printing: Print settings for the header, annotation, footer, grid, date, recording name, time axis, and recording speed printed at the same time as the printer printing</p> <p>Text settings: Inputs and imports/exports text for printing headers, annotations, and footers 60 characters for the text (in the paper feed direction) x 86 lines (waveform amplitude direction)</p> <p>Chart speed: Sets a user-defined chart speed. Six speed settings can be set.</p>

Item	Specifications		
Record Management	List of recorded data	Displays a list of the data recorded to this product.	
	Choice	Selects recorded data in the list. Multiple data can be selected.	
	Select all	Selects all the recorded data in the list.	
	Release all	Deselects all the data in the list.	
	Delete	Deletes the selected recorded data.	
	Export / Import	Export	Writes recorded data to USB memory or an SD memory card.
		Import	Reads recorded data saved on USB memory or an SD memory card.
	Restore recording setup	Reads settings information from the selected recorded data and sets it in the main unit.	
Image Management	Image list	Displays a list of the images recorded to this product.	
	Choice	Selects images in the list. Multiple data can be selected.	
	Select all	Selects all the image data in the list.	
	Release all	Deselects all the data in the list.	
	Delete	Deletes the selected images.	
	Print	Prints the selected images from the printer.	
	Export	Outputs the selected images to USB memory or an SD memory card.	
Environment	PC name	Sets the name of the main unit using 15 characters or less. This name is used for identification purposes on the network and in recorded data.	
	Language	English	
	Time zone	Sets the time zone (regional standard time). Daylight savings time available.	
	Date and time	Sets the current date and time.	
	Backlight timer		Backlight timer automatic disable setting Select [OFF], [1 minutes], [5 minutes], [10 minutes], [30 minutes], or [60 minutes]
			The backlight of the LCD display automatically turns off at the set time.
	Display brightness	Sets the brightness of the LCD display.	
Display	Grid	Switches the grid lines of the waveform screen on or off.	
	Trigger line	Switches the trigger lines of the waveform screen on or off.	
	Mark line	Switches the mark lines of the waveform screen on or off.	

## 8.2.10. Interface Specifications

Item	Specifications	
LAN	Supported standard	IEEE802.3 (1000BASE-T, 100BASE-TX, 10BASE-T)
	Connector	RJ-45
	Number of ports	1
USB	Supported standard	USB3.0
	Connector	Type-A
	Number of ports	2
SD	Supported standard	SD standard (SD/SDHC/SDXC supported)
	Connector	Slot for SD memory cards
	Number of ports	1
COM	Supported standard	EIA-574
	Connector	D-Sub9
	Number of ports	1
DVI-D	Supported standard	DVI-D (dual link not supported)
	Connector	DVI-D
	Number of ports	1

## 8.2.11. Communication Setup

Item	Specifications	
Network Settings	IP address setup	Select to automatically retrieve or manually set the IP address. When manually setting the IP address, the IP address, subnet mask, and default gateway can be manually set.
	IP address	Set the IP address.
	Subnet mask	Set the subnet mask.
	Default gateway	Set the default gateway.
	DNS server address setup	Select to automatically retrieve or manually set the DNS server. When manually setting the DNS server the preferred DNS server and alternate DNS server can be set.
	Preferred DNS server	Set the preferred DNS server.
	Alternate DNS server	Set the alternate DNS server.
RS-232C Settings	Baud rate	Select the RS-232C baud rate. 300 to 460800 bps
	Data bits	The RS-232C data bit length, fixed to 8 bits
	Stop bits	Select the RS-232C stop bits. Select 1 or 2 bits.
	Parity	Select the RS-232C parity. None, odd, even, mark, or space
	Flow control	Select the RS-232C flow control method. Select none, XON/XOFF, or hardware (CTS/RTS).

## 8.2.12. Other Settings

## (Maintenance / Operation History / Version Management)

Item	Specifications
SSD check	SSD life remaining, health check, and loading test
Fan check	Displays the state of the internal cooling fan
LCD check	LCD screen check and pixel defect check
Brightness check	LCD back light brightness control check
Printer	Prints a test patten from the printer Printer state check: System, motor, head temperature, printer cover, recording paper
Buzzer	Controls the buzzer on/off to check the buzzer
Panel keys	Press the panel keys to check whether they operate normally
Panel key LED	Turns the panel LEDs on/off to check whether they operate normally
Initialization	Returns the settings of the main unit to the factory defaults.
Operation history display	Displays the history of the past 100 operations.
Version management	Displays the serial number and version of this product and the version information of each module



## 8.3. Exterior

### 8.3.1. Main Unit Exterior

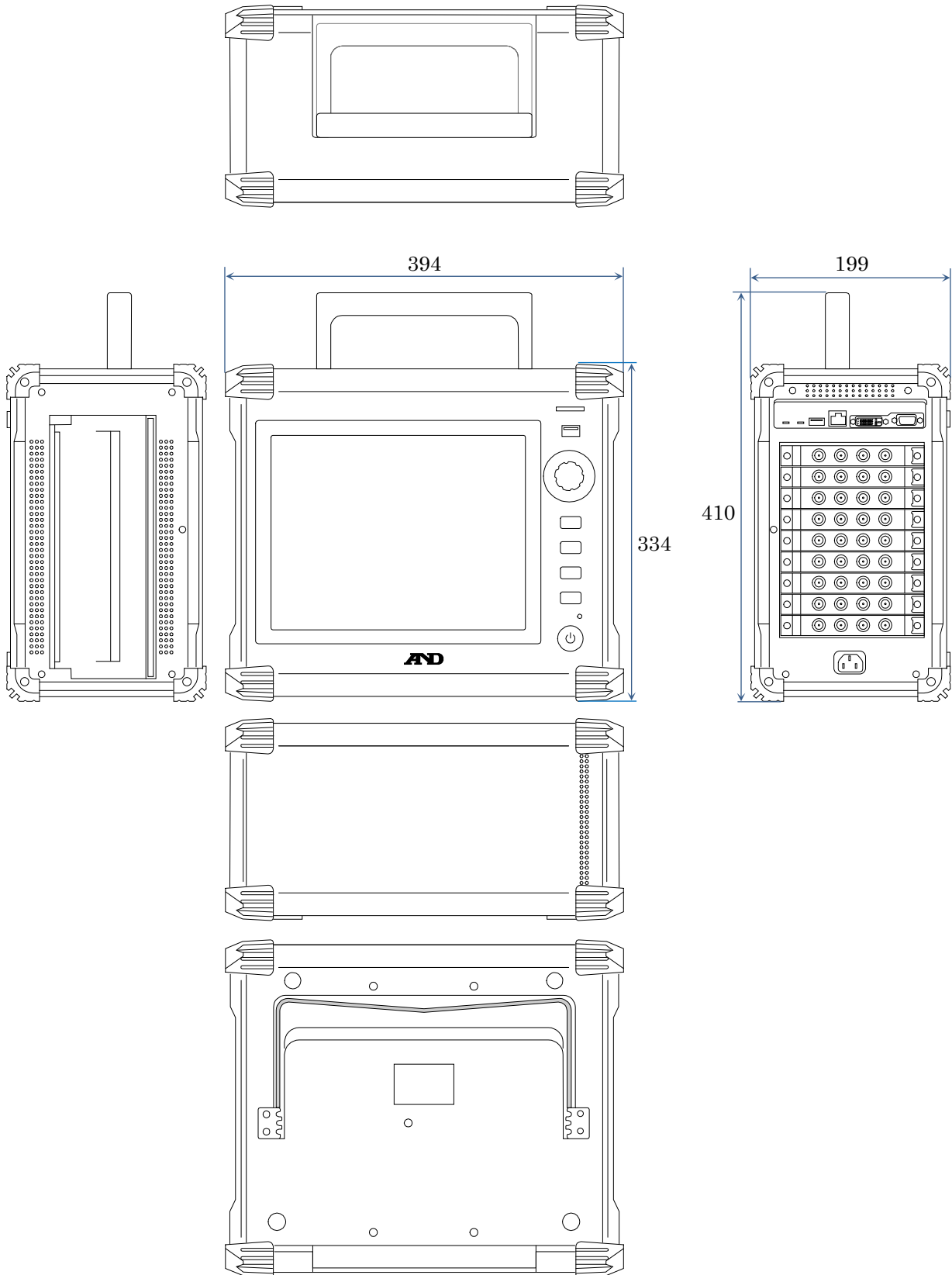

# Information on Software Licenses

The software embedded in this product includes software components owned by third parties. The licenses for the software components embedded in this product are indicated below.

## SIL Open Font License

Copyright 2014-2021 Adobe (<http://www.adobe.com/>), with Reserved Font Name 'Source'. Source is a trademark of Adobe in the United States and/or other countries.

This Font Software is licensed under the SIL Open Font License, Version 1.1.

This license is copied below, and is also available with a FAQ at: <http://scripts.sil.org/OFL>

-----  
SIL OPEN FONT LICENSE Version 1.1 - 26 February 2007  
-----

## PREAMBLE

The goals of the Open Font License (OFL) are to stimulate worldwide development of collaborative font projects, to support the font creation efforts of academic and linguistic communities, and to provide a free and open framework in which fonts may be shared and improved in partnership with others.

The OFL allows the licensed fonts to be used, studied, modified and redistributed freely as long as they are not sold by themselves. The fonts, including any derivative works, can be bundled, embedded, redistributed and/or sold with any software provided that any reserved names are not used by derivative works. The fonts and derivatives, however, cannot be released under any other type of license. The requirement for fonts to remain under this license does not apply to any document created using the fonts or their derivatives.

## DEFINITIONS

"Font Software" refers to the set of files released by the Copyright Holder(s) under this license and clearly marked as such. This may include source files, build scripts and documentation.

"Reserved Font Name" refers to any names specified as such after the copyright statement(s).

"Original Version" refers to the collection of Font Software components as distributed by the Copyright Holder(s).

"Modified Version" refers to any derivative made by adding to,

deleting, or substituting -- in part or in whole -- any of the components of the Original Version, by changing formats or by porting the Font Software to a new environment.

"Author" refers to any designer, engineer, programmer, technical writer or other person who contributed to the Font Software.

#### PERMISSION & CONDITIONS

Permission is hereby granted, free of charge, to any person obtaining a copy of the Font Software, to use, study, copy, merge, embed, modify, redistribute, and sell modified and unmodified copies of the Font Software, subject to the following conditions:

- 1) Neither the Font Software nor any of its individual components, in Original or Modified Versions, may be sold by itself.
- 2) Original or Modified Versions of the Font Software may be bundled, redistributed and/or sold with any software, provided that each copy contains the above copyright notice and this license. These can be included either as stand-alone text files, human-readable headers or in the appropriate machine-readable metadata fields within text or binary files as long as those fields can be easily viewed by the user.
- 3) No Modified Version of the Font Software may use the Reserved Font Name(s) unless explicit written permission is granted by the corresponding Copyright Holder. This restriction only applies to the primary font name as presented to the users.
- 4) The name(s) of the Copyright Holder(s) or the Author(s) of the Font Software shall not be used to promote, endorse or advertise any Modified Version, except to acknowledge the contribution(s) of the Copyright Holder(s) and the Author(s) or with their explicit written permission.
- 5) The Font Software, modified or unmodified, in part or in whole, must be distributed entirely under this license, and must not be distributed under any other license. The requirement for fonts to remain under this license does not apply to any document created using the Font Software.

#### TERMINATION

This license becomes null and void if any of the above conditions are not met.

#### DISCLAIMER

THE FONT SOFTWARE IS PROVIDED "AS IS", WITHOUT WARRANTY OF ANY KIND, EXPRESS OR IMPLIED, INCLUDING BUT NOT LIMITED TO ANY WARRANTIES OF MERCHANTABILITY, FITNESS FOR A PARTICULAR PURPOSE AND NONINFRINGEMENT

OF COPYRIGHT, PATENT, TRADEMARK, OR OTHER RIGHT. IN NO EVENT SHALL THE COPYRIGHT HOLDER BE LIABLE FOR ANY CLAIM, DAMAGES OR OTHER LIABILITY, INCLUDING ANY GENERAL, SPECIAL, INDIRECT, INCIDENTAL, OR CONSEQUENTIAL DAMAGES, WHETHER IN AN ACTION OF CONTRACT, TORT OR OTHERWISE, ARISING FROM, OUT OF THE USE OR INABILITY TO USE THE FONT SOFTWARE OR FROM OTHER DEALINGS IN THE FONT SOFTWARE.





Omniace  
RA3100

Simple Instruction Manual

1WMPD4004445B

3rd Edition



### **A&D Company, Limited**

3-23-14 Higashi-Ikebukuro, Toshima-ku, Tokyo 170-0013, JAPAN  
Telephone: [81] (3) 5391-6132 Fax: [81] (3) 5391-1566

### **A&D ENGINEERING, INC.**

1756 Automation Parkway, San Jose, California 95131, U.S.A.  
Telephone: [1] (408) 263-5333 Fax: [1] (408) 263-0119

### **A&D INSTRUMENTS LIMITED**

Unit 24/26 Blacklands Way, Abingdon Business Park, Abingdon, Oxfordshire OX14 1DY United Kingdom  
Telephone: [44] (1235) 550420 Fax: [44] (1235) 550485

### **A&D AUSTRALASIA PTY LTD**

32 Dew Street, Thebarton, South Australia 5031, AUSTRALIA  
Telephone: [61] (8) 8301-8100 Fax: [61] (8) 8352-7409

### **A&D KOREA Limited**

한국에이.엔.디(주)  
서울특별시 영등포구 국제금융로6길33 (여의도동) 맨하탄빌딩 817 우편 번호 07331  
( 817, Manhattan Bldg., 33. Gukjegeumyung-ro 6-gil, Yeongdeungpo-gu, Seoul, 07331 Korea )  
전화: [82] (2) 780-4101 팩스: [82] (2) 782-4264

### **OOO A&D RUS**

### **ООО "ЭЙ энд ДИ РУС"**

Почтовый адрес: 121357, Российская Федерация, г.Москва, ул. Верейская, дом 17  
Юридический адрес: 117545, Российская Федерация, г. Москва, ул. Дорожная, д.3, корп.6, комн. 86  
( 121357, Russian Federation, Moscow, Vereyskaya Street 17 )  
тел.: [7] (495) 937-33-44 факс: [7] (495) 937-55-66

### **A&D Instruments India Private Limited**

### **ऐ&डी इन्स्ट्रुमेंट्स इण्डिया प्रा० लिमिटेड**

509, उद्योग विहार, फेस -5, गुडगांव - 122016, हरियाणा, भारत  
( 509, Udyog Vihar, Phase-V, Gurgaon - 122016, Haryana, India )  
फोन : [91] (124) 4715555 फैक्स : [91] (124) 4715599

### **A&D SCIENTECH TAIWAN LIMITED. A&D台灣分公司 艾安得股份有限公司**

台湾台北市中正區青島東路5號4樓  
( 4F No.5 Ching Tao East Road, Taipei Taiwan R.O.C. )  
Tel : [886](02) 2322-4722 Fax : [886](02) 2392-1794

### **A&D INSTRUMENTS (THAILAND) LIMITED**

บริษัท เอ แอนด์ ดี อินสตรูमेंท์ (ไทยแลนด์) จำกัด  
168/16 หมู่ที่ 1 ตำบลรังสิต อำเภอธัญบุรี จังหวัดปทุมธานี 12110 ประเทศไทย  
( 168/16 Moo 1, Rangsit, Thanyaburi, Pathumthani 12110 Thailand )  
Tel : [66] 20038911