

RA3100

Omniace

Communication command

Instruction Manual



A&D Company, Ltd.

CAUTION

- (1) Turn off the power when an error occurs with the product.
If it is not possible to trace the cause of a problem, please contact our sales representative.
- (2) The contents of this manual are subject to change without notice.
- (3) This manual is copyrighted with all rights reserved. This manual may not be reproduced, modified, or translated without the written permission of A&D Company, Limited. No parts of this manual may be transcribed without permission.
- (4) Please let us know if any points are unclear or missing in this manual.
- (5) A&D Company, Limited. will not be held responsible for any damages or loss of income caused by the operation of this device or any direct, indirect, special, or inevitable damages caused by defects in the product, even if there is notice that the corresponding damages may occur. We will also not be held responsible for any third-party claims of rights. At the same time, we will not be held responsible for any loss of data. We will not be held responsible for any issues that arise that are caused by problems with the manual.

© 2022 A&D Company, Limited.

- Omnice is a registered trademark of A&D Company, Limited.
- Microsoft, Windows and Windows 10 IoT are trademarks or registered trademarks of Microsoft Corporation in the United States and other countries.
- Software owned by Adobe Corporation in the United States is used based on the SIL Open Font License.
- Product names and company names in this manual are trademarks or registered trademarks of their respective owners in Japan and other countries.

Introduction

We thank you for your purchase of our data acquisition product OMNIACE RA3100 (hereinafter "the RA3100" or "this product").

This instruction manual explains how to use the communication interface and the communication commands when controlling communication using the LAN interface or the RS-232C interface.

Please read this manual carefully to use this product correctly before using this product.

Please read this instruction manual, which is provided on the included CD, as it gives details of the functions and operations of the input module and the RA3100. Read the corresponding manuals of the PC (controller) connected to the interface to ensure correct use.

If you have questions or are unsure of the instructions given in this manual, please contact us.













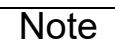

<Instruction manual>

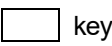
Name	Descriptions
RA3100 instruction manual	Operations and settings of parameters for RA3100 are described.

Symbols in This Manual

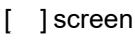
Terms and symbols used in this manual denote as follows.

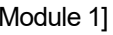
 WARNING	This indicates a condition or practice that could result in personal injury or loss of life, or may result in light injury or physical damage if this equipment is misused due to neglect of a Warning.
 CAUTION	This indicates a condition or practice that could result in light injury or damage to the equipment or other property if this equipment is misused due to neglect of a Caution.
 Note	This indicates a condition or practice that could result in incorrect operation or damage to data if this equipment is misused due to neglect of a Note.
 Tips	This indicates configuration limitations and additional explanations.
	Reference page
	A tap is the act of lightly touching an item such as a key displayed on the screen with a finger. Example: Used for selecting or setting screen keys.
 key	Enclosed characters represent a key name on the operation panel. Example:  key
 key	Text enclosed in  indicates touch panel keys displayed on the screen. Example:  key
 screen	Text enclosed in  indicates the text of items on the screen. Example: 
k (lower case) K (upper case)	Example: 1 kg = 1000 g 1 KB = 1024 bytes

Introduction

The meaning of the notation and symbols used for messages is indicated below.

< >	Defined value
[]	May be omitted
{ } 	Select one of the items in the curly brackets

Contents

Introduction	3
<Instruction manual>	3
Symbols in This Manual.....	3
1. Communication settings.....	7
1.1. Preparing the product.....	7
1.1.1. Connections of communication ports	7
1.1.2. Network setup for LAN port	8
1.1.3. Communication parameters of RS-232C (COM port)	10
2. Overview of communication commands	11
2.1. Communication format	11
2.1.1. Message format.....	11
2.1.2. Communication protocol.....	15
2.2. Command List	16
2.2.1. Command groups	16
2.2.2. Command List	16
3. Details of command	18
3.1. Settings of main unit (S commands)	18
3.1.1. S01: Common recording configuration and querying	18
3.1.2. S02: Memory recording configuration and querying	19
3.1.3. S03: SSD recording configuration and querying	21
3.1.4. S04: Printer recording configuration and querying	22
3.1.5. S21: Start-trigger configuration and querying (analog input signal)	23
3.1.6. S22: Start-trigger configuration and querying (logical input signal).....	24
3.1.7. S24: Memory-trigger configuration and querying (analog input signal)	25
3.1.8. S25: Memory-trigger configuration and querying (logical input signal)	27
3.1.9. S26: Memory-trigger mode configuration and querying	28
3.1.10. S30: Channel format configuration and querying	28
3.1.11. S31: Logical input display signal configuration and querying	30
3.1.12. S32: Scale conversion configuration and querying	32
3.1.13. S33: Unit list configuration and querying.....	33
3.1.14. S34: Recording name configuration and querying	34
3.1.15. S35: Thumbnail configuration and querying.....	34
3.1.16. S36: Print parameter configuration and querying.....	35
3.1.17. S37: Header, footer, and annotation configuration and querying.....	36
3.1.18. S39: Y-T waveform format configuration and querying	37
3.1.19. S40: X-Y waveform configuration and querying	38
3.1.20. S41: X-Y waveform channel configuration and querying	38
3.1.21. S42: FFT analysis configuration and querying	39
3.1.22. S43: Waveform area division configuration and querying	42
3.1.23. S44: Feed length configuration and querying	43
3.1.24. S45: Recording information XML file output configuration and querying	44
3.1.25. S46: Division count configuration and querying	44
3.1.26. S48: Measurement mode configuration and querying	45
3.1.27. S49: TRIG key function configuration and querying.....	45
3.1.28. S50: Data transfer configuration and querying.....	46

Table of contents

3.1.29.	S51: Date and time configuration and querying	47
3.1.30.	S52 : CSV format configuration and querying	48
3.2.	Module setting (M commands).....	49
3.2.1.	M01: RA30-101 (2ch voltage module) configuration and querying	49
3.2.2.	M02: RA30-102 (4ch voltage module) configuration and querying	50
3.2.3.	M03: RA30-103 (2ch high speed voltage module) configuration and querying	51
3.2.4.	M04: RA30-104 (2ch AC strain module) configuration and querying	52
3.2.5.	M05: RA30-105 (16ch logic module) configuration and querying	54
3.2.6.	M06: RA30-106 (2ch temperature module) configuration and querying	55
3.2.7.	M07: RA30-107 (2ch high voltage module) configuration and querying	57
3.2.8.	M08: RA30-108 (2ch frequency module) configuration and querying.....	58
3.2.9.	M09: RA30-109 (2ch acceleration module) configuration and querying	61
3.2.10.	M12: RA30-112 (remote control module) configuration and querying	64
3.2.11.	M13: RA30-113 (4ch voltage module) configuration and querying	65
3.3.	Reading information (I commands).....	67
3.3.1.	I00: Reading information of main unit, type, serial No.	67
3.3.2.	I04: Reading board information of input module	67
3.3.3.	I05: Reading the status of main unit.....	68
3.3.4.	I07: Recording setting error readout.....	69
3.3.5.	I09: Physical quantity calculation coefficient readout.....	70
3.3.6.	I10: Recording data count readout.....	71
3.3.7.	I11: Data transfer status readout	71
3.3.8.	I12: Used block count readout.....	71
3.4.	Execution process (E commands)	72
3.4.1.	E01: Execute canceling the input offset (zero-cancel).....	72
3.4.2.	E07: Execute start and end recording	72
3.4.3.	E15: Feed execution.....	73
3.4.4.	E16: Execute print header, footer and annotation	73
3.4.5.	E17: TRIG execution	73
3.4.6.	E18: MARK execution	74
3.4.7.	E19: PRINT control.....	74
3.4.8.	E22: BAL execution	74
3.4.9.	E23: Bridge check	75
3.4.10.	E24: TEDS readout	75
3.4.11.	E25: Count reset.....	76
3.4.12.	E27: Recorded data deletion.....	76
3.4.13.	E29: Data transfer manual control.....	77
3.4.14.	E32: Saved data deletion	77
4.	Specifications of hardware.....	78
4.1.	LAN port	78
4.2.	COM port.....	78
5.	Appendix	79
5.1.	Command operation procedure	79
5.1.1.	Recording settings.....	79
5.1.2.	Start or stop recording	80
5.2.	Cautions when using the scale conversion function and wave inversion function	81

1. Communication settings

The RA3100 is equipped with an interface with a LAN port and a COM port (RS-232C), which are used to connect to peripherals.

LAN port is 1000BASE-T, 100BASE-TX and 10BASE-T in accordance with IEEE802.3.

Cables conforming to the relevant standards of the connections should be used.

Use crossover cables when directly connecting to a computer using RS-232C.

1.1. Preparing the product

1.1.1. Connections of communication ports

The interface is mounted on the rear panel of the RA3100. Connect a cable to the LAN port when using ethernet. Connect a cable to the RS-232C when using COM port.

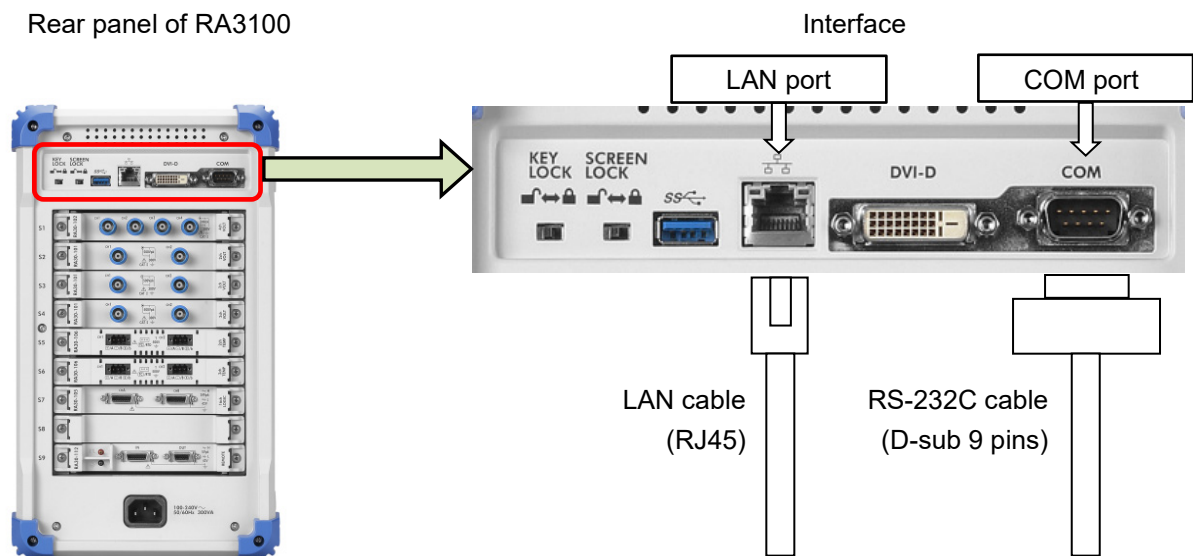

Connection using LAN cable

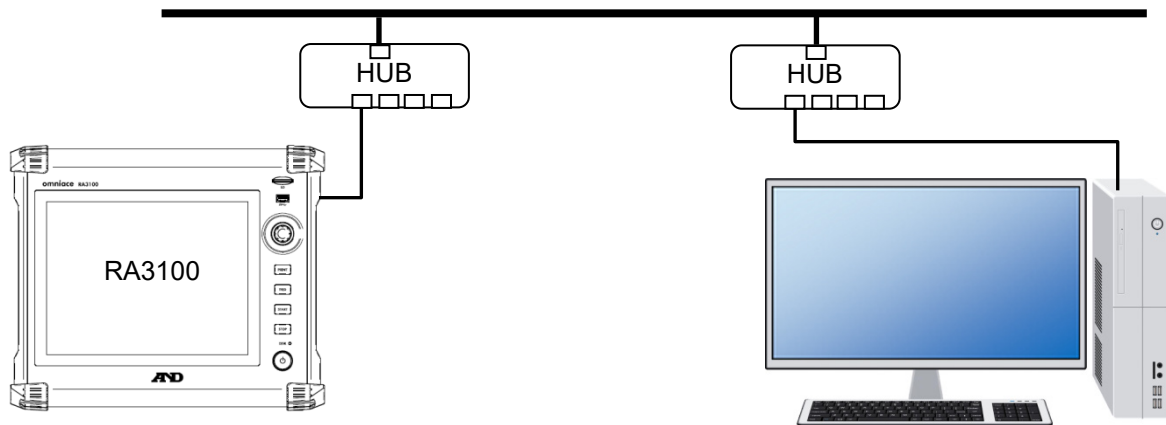

Connection using RS-232C cable

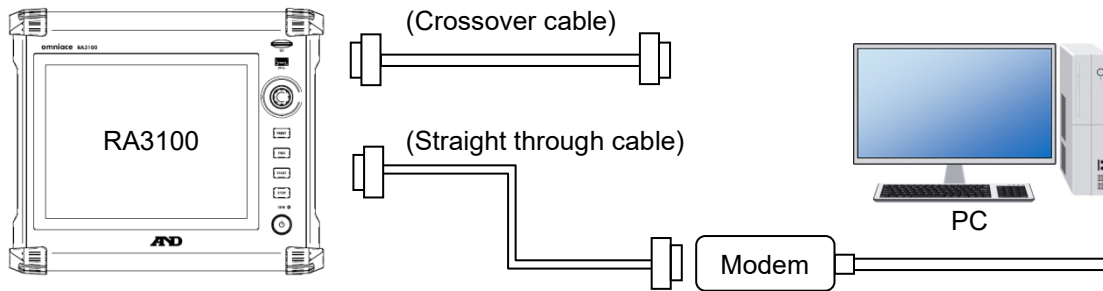

Use crossover cable when connecting to computer, DTE device and others using RS-232C.
Use straight through cable when connecting to DCE device.

1.1.2. Network setup for LAN port

This section describes for setup of LAN port.

The current settings are displayed by the following procedure.

Step 1 Tap **[Setup]** key of the "**side menu**" on the display block.

Step 2 Tap **[Comm.]** on the [Main unit setup] screen to display the [Comm.] settings screen, which indicates the current setting values.

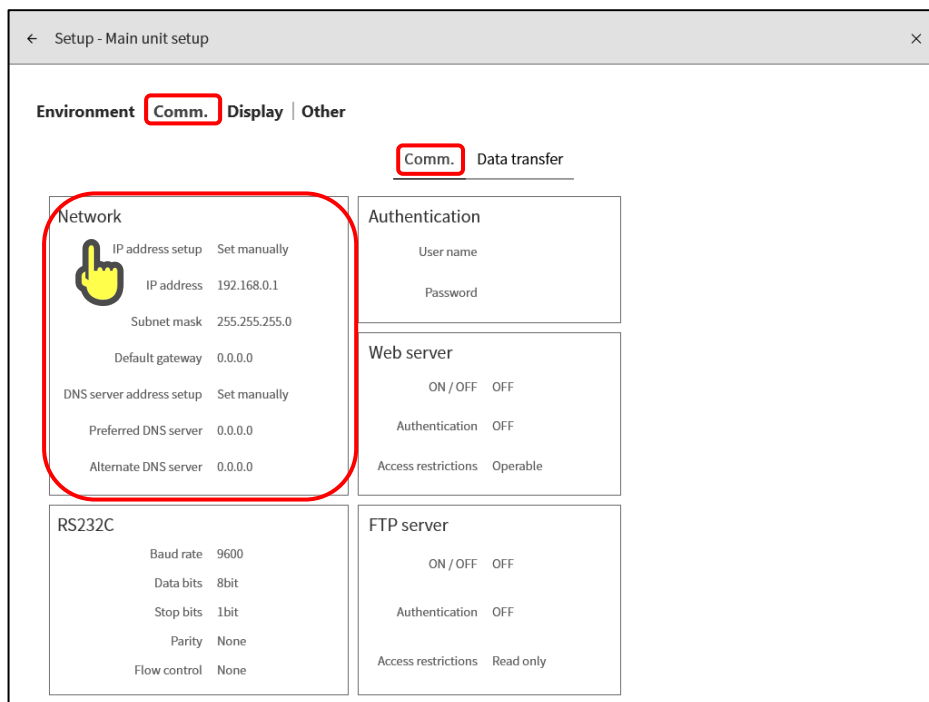

Tap the Network box to display the network settings screen.

Consult a network manager for the settings when connecting to an ethernet network.

(1) IP address setup:

Select whether to "obtain automatically" or "set manually".

When "obtain automatically" is selected, IP address is set automatically by the DHCP server on the network. Then, the address of the DNS server is set automatically because automatic setup of the DNS server is enabled.

When "set manually" is selected, IP address, subnet mask, gateway and DNS server address needs to be set manually.

(2) IP address:

Specify an IP address that is a unique number on the network and consists of a network address + device address if "obtain automatically" is selected.

Example:

IP address of the RA3100 is set to "192.168.0.1". IP address of computer is set to "192.168.0.10".

(3) Subnet mask:

The value that defines the IP address range (subnet).

In the case of "192.168.0.1", the subnet mask should be set to "255.255.255.0".

(4) Default gateway:

Sets the IP address of the gateway device for connecting the network that the product is connected to with external networks.

(5) Preferred DNS server:

Sets the IP address of the preferred DNS server on the network. The DNS server converts automatically domain name to IP address.

(6) Alternate DNS server:

Sets the IP address of the alternate DNS server on the network.

Network setup dialog box

The screenshot shows a 'Network' dialog box with the following elements:

- (1) IP address setup: Set manually (dropdown)
- (2) IP address: 192, 168, 0, 1
- (3) Subnet mask: 255, 255, 255, 0
- (4) Default gateway: 0, 0, 0, 0
- DNS server address setup: Set manually
- (5) Preferred DNS server: 0, 0, 0, 0
- (6) Alternate DNS server: 0, 0, 0, 0
- Buttons: OK, Cancel

Tips

Specify port number "3000" when using the LAN port to communicate with an external device.

1.1.3. Communication parameters of RS-232C (COM port)

The current settings are displayed by the following procedure.

Step 1 Tap **【 Setup】** key of the "**side menu**" on the display block.

Step 2 Tap **【 Environment】** key of "**Main unit setup**" item of the [Setup] screen.

Step 3 Tap the RS-232C box to display the RS-232C settings screen.

When using the RS-232C port of this product to communicate with an external device, match the RS-232C settings with those of the PC.

(1) Baud rate:

Sets the RS-232C data transmission speed.

300 / 600 / 1200 / 2400 / 4800 / 9600 / 14400 / 19200 /
38400 / 57600 / 115200 / 230400 / 460800 bps

(2) Data bits:

The number of bits in one byte of data. Fixed to 8 bits.

(3) Stop bits:

The stop bits in one byte of data. Select 1 or 2 bits.

(4) Parity:

The parity bit for one byte of data.

None, Odd, Even, Mark, or Space

(5) Flow control:

The flow control of communication using CTS/RTS.

None, Xon/Xoff, or Hardware

RS-232C setup dialog box

The image shows a screenshot of the RS-232C setup dialog box. The dialog box has a title bar that says "RS232C". Inside the dialog box, there are five settings, each with a number in parentheses to its left: (1) Baud rate is set to 9600; (2) Data bits is set to 8bit; (3) Stop bits is set to 1bit; (4) Parity is set to None; (5) Flow control is set to None. Each setting is followed by a dropdown arrow. At the bottom of the dialog box, there are two buttons: "OK" and "Cancel".

2. Overview of communication commands

When this product is connected to a PC via LAN or RS-232C and receives a command from the PC, it executes the process according to the command. LAN is TCP/IP socket communication, and RA3100 communicates as a server.

Note

- When communicating, there is no particular distinction between LAN or RS-232C communication ports, and processing is performed when a command is received. However, if commands are received from both ports at the same time, it may cause malfunctions to occur, so only one of the communication ports should be used.
- Use ASCII and UTF-8 codes for communication of the RA3100. Characters of JIS, SJIS, EUC codes and others become a garbled text.

2.1. Communication format

2.1.1. Message format

In order to control the RA3100 from a PC, messages are used for communication between the PC and RA3100.

Messages sent from the PC to the RA3100 are command messages and messages sent from the RA3100 to the PC are response messages. Response messages include ACK messages and NAK messages.

One response message is always returned for one command message.

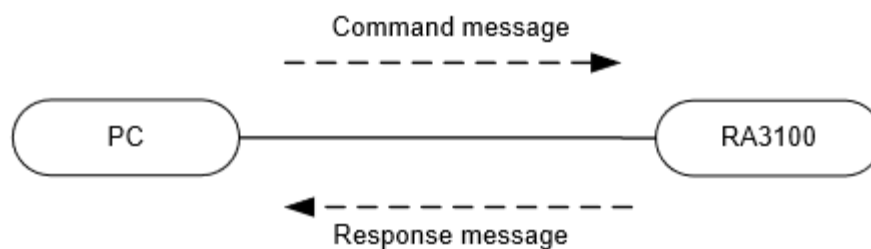

A message consists of a frame and terminator (delimiter).

The terminator is <CR><LF> [0x0D0A].

Format:

Message	
Frame	Terminator
<FRAME>	<CR><LF>

Command message

The frame of a command message includes a command and its parameters, and enables configuration, readout, or execution to be processed.

You can add a question mark (?) to a command to submit a query regarding the current parameter setting information.

If parameters are included, they are separated with a separator (single-byte space).

Format:

Command	Question mark	Separator	Parameter
<CMD>	[?]	<SP>	<PARAMS>

(Example) I00
 S03 1,12,,0
 S03?
 S30? 1,1

<CMD>

Three characters expressing the type of command. For details, refer to "2.2 Command List".

<SP>

A single-byte space [0x20].

<PARAMS>

Multiple parameters are separated with comma "," [0x2C].

Enclose the string parameter of a signal name etc. with <STX> [0x02] and <ETX> [0x03].

Use ASCII and UTF-8 codes for the string parameter.

Exponential, decimal and integer notation can use when exponential notation is used in a parameter description.

It is not necessary to specify a value for a parameter unless the setting is to be changed.

Response message

When a command message is recognized and processed successfully, an ACK message (normal response) is returned.

If an error such as a format error or execution error occurs for the command message, an NAK message (error response) is returned.

ACK message (normal response)

There are two types of ACK message: standard ACK and ACK with data.

Standard ACK

The frame consists of a confirmation response and reception command.

The confirmation response and reception command are separated with a separator (single-byte space).

Format:

Confirmation response	Separator	Reception command
ACK	<SP>	<CMD>

(Example) ACK S01

ACK with data

The frame consists of a confirmation response, reception command, and data.

The confirmation response and reception command are separated with a separator (single-byte space).

The confirmation response and data are separated with a comma (,).

Format:

Confirmation response	Separator	Reception command	Comma	Data
ACK	<SP>	<CMD>[?]	,	<DATA>

(Example) ACK I05,1
ACK S03?,1,12,,0

<DATA>

Multiple parameters are separated with comma "," [0x2C].

Enclose the string parameter of a signal name etc. with <STX> [0x02] and <ETX> [0x03].

Use ASCII and UTF-8 codes for the string parameter.

NAK message (error response)

There are three types of NAK message: execution error NAK, frame error NAK, and busy error NAK.

Execution error NAK

The response message when an error occurs with the received command.

The frame consists of a confirmation response, reception command, error number, and parameter number.

The confirmation response and reception command are separated with a separator (single-byte space).

The reception command, error number, and parameter number are separated with a comma (,).

Format:

Confirmation response	Separator	Reception command	Comma	Error number	Comma	Parameter number
NAK	<SP>	<CMD>[?]	,	<ERR>	,	<PARAMNUM>

(Example) NAK S01,4,1
NAK M01?,7,-1

Frame error NAK

The response message when a command message cannot be recognized.

The frame consists of a confirmation response and type.

The confirmation response and type are separated with a separator (single-byte space).

Format:

Confirmation response	Separator	Type
NAK	<SP>	<TYPE>

(Example) NAK HAD

Busy error NAK

The response message when another command is being processed.

The frame consists of a confirmation response and type.

The confirmation response and type are separated with a separator (single-byte space).

Format:

Confirmation response	Separator	Type
NAK	<SP>	BSY

(Example) NAK BSY

<ERR>

Error number and descriptions are as follows:

When an error occurs, the following error numbers are replied as a parameter of NAK.

() means system error inside of the RA3100.

Error number	Descriptions
1	Command busy.
2	Settings cannot be changed because recording is continued.
3	Unknown command.
4	Parameter is out of range.
5	Number of parameters is incorrect.
6	Time out.
7	(Unknown device)
8	(Common memory error)
9	Deficiency of required parameter.
10	Storage device has been filled.
11	Full memory.
12	(Internal bus error)
13	Execution failure.

<PARAMNUM>

Parameter number shows which parameter in receiving command has failed.

Negative value is replied to parameter number if it cannot be identified.

<TYPE>

The types of frame errors are indicated in the table below.

Type	Descriptions
HAD	3-character command could not be recognized.
DEL	A terminator could not be recognized in the command message.
FMT	Syntax error.

2.1.2. Communication protocol

When a command is issued from a PC, this product always responds with an ACK or NAK message once the process is complete after reception. The PC should execute the next process after confirming this response.

- * The ACK message for some commands is sent before the process is complete. Refer to the remarks in each command.

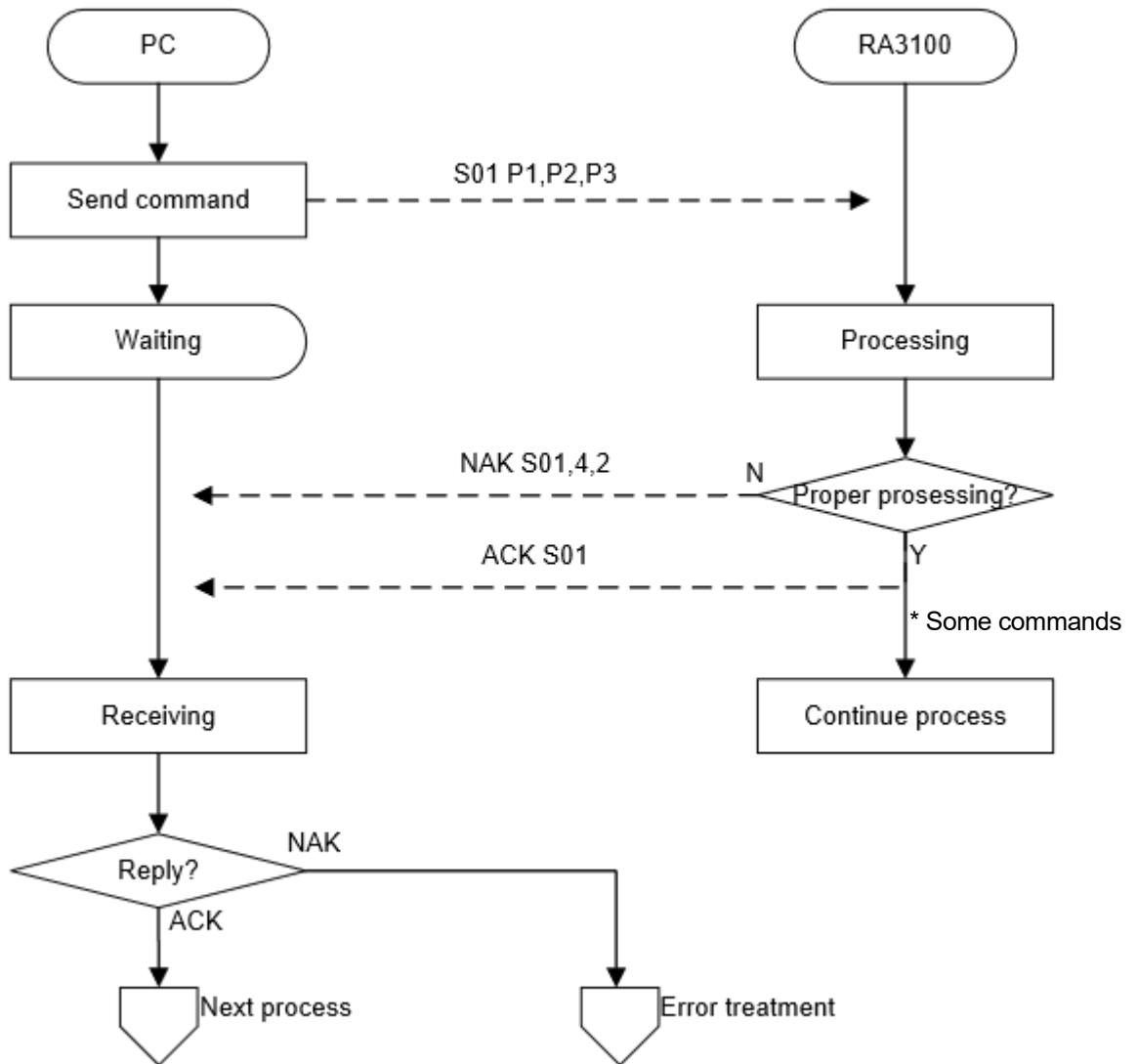

*Dotted lines indicate communication

2.2. Command List

First character of 3-character command shows type of command. Other characters show content of command.

Example : S04

S : S command

04 : Settings of recording printer

2.2.1. Command groups

Types of command are as follows:

First character	Descriptions	Details
S	S command : Settings of main unit	3.1. Settings of main unit
M	M command : Module setting	3.2. Module setting
I	I command : Reading information	3.3. Reading information
E	E command : Execution process	3.4. Execution process

2.2.2. Command List

Settings of main unit (S commands)

Command	Descriptions	Details
S01	Common recording configuration and querying	S01
S02	Memory recording configuration and querying	S02
S03	SSD recording configuration and querying	S03
S04	Printer recording configuration and querying	S04
S21	Start-trigger configuration and querying (analog input signal)	S21
S22	Start-trigger configuration and querying (logical input signal)	S22
S24	Memory-trigger configuration and querying (analog input signal)	S24
S25	Memory-trigger configuration and querying (logical input signal)	S25
S26	Memory-trigger mode configuration and querying	S26
S30	Channel format configuration and querying	S30
S31	Logical input display signal configuration and querying	S31
S32	Scale conversion configuration and querying	S32
S33	Unit list configuration and querying	S33
S34	Recording name configuration and querying	S34
S35	Thumbnail configuration and querying	S35
S36	Print parameter configuration and querying	S36
S37	Header, footer, and annotation configuration and querying	S37
S39	Y-T waveform format configuration and querying	S39
S40	X-Y waveform configuration and querying	S40
S41	X-Y waveform channel configuration and querying	S41
S42	FFT analysis configuration and querying	S42
S43	Waveform area division configuration and querying	S43
S44	Feed length configuration and querying	S44
S45	Recording information XML file output configuration and querying	S45
S46	Division count configuration and querying	S46
S48	Measurement mode configuration and querying	S48
S49	TRIG key function configuration and querying	S49
S50	Data transfer configuration and querying	S50
S51	Date and time configuration and querying	S51
S52	CSV format configuration and querying	S52

Module setting (M commands)

Command	Descriptions	Details
M01	RA30-101 (2ch voltage module) configuration and querying	M01
M02	RA30-102 (4ch voltage module) configuration and querying	M02
M03	RA30-103 (2ch high speed voltage module) configuration and querying	M03
M04	RA30-104 (2ch AC strain module) configuration and querying	M04
M05	RA30-105 (16ch logic module) configuration and querying	M05
M06	RA30-106 (2ch temperature module) configuration and querying	M06
M07	RA30-107 (2ch high voltage module) configuration and querying	M07
M08	RA30-108 (2ch frequency module) configuration and querying	M08
M09	RA30-109 (2ch acceleration module) configuration and querying	M09
M12	RA30-112 (remote control module) configuration and querying	M12
M13	RA30-113 (4ch voltage module) configuration and querying	M13

Reading information (I commands)

Command	Descriptions	Details
I00	Reading information of main unit, type, serial No.	I00
I04	Reading board information of input module	I04
I05	Reading the status of main unit	I05
I07	Recording setting error readout	I07
I09	Physical quantity calculation coefficient readout	I09
I10	Recording data count readout	I10
I11	Data transfer status readout	I11
I12	Used block count readout	I12

Executions process (E commands)

Command	Descriptions	Details
E01	Execute canceling the input offset (zero-cancel)	E01
E07	Execute start and end recording	E07
E15	Feed execution	E15
E16	Execute print header, footer and annotation	E16
E17	TRIG execution	E17
E18	MARK execution	E18
E19	PRINT control	E19
E22	BAL execution	E22
E23	Bridge check	E23
E24	TEDS readout	E24
E25	Count reset	E25
E27	Recorded data deletion	E27
E29	Data transfer manual control	E29
E32	Saved data deletion	E32

3. Details of command

3.1. Settings of main unit (S commands)

3.1.1. S01: Common recording configuration and querying

Command	S01
Command message	Setting: S01 <P1>,<P2>, . . . ,<P13> Query: S01?
Response message	Setting: ACK S01 Query: ACK S01?,<P1>,<P2>, . . . ,<P13>
Remarks	Configures or submits a query on the common settings regarding main unit recording. Refer to " Setup Details " – " Recording " in the instruction manual of the RA3100.

Parameters

P1	Recording mode
Data range	0 to 8 0 : Basic 2 : START trigger 4 : Start time + START trigger 6 : Start time + Interval time 8 : Window record 1 : Start time 3 : Interval time 5 : START trigger + Interval time 7 : Start time + START trigger + Interval time

P2	Record number of interval time mode
Data range	1 to 10000
Remarks	Available number of settings is different due to recording time, type of recording media and remaining capacity of SSD.

P3	Maximum recording time
Data range	0 or 1 0 : Invalid 1 : Effective
Remarks	If effective, recording time is maximum time that can be used remaining capacity of SSD at starting time. In this case, maximum time is calculated with remaining capacity, "sampling rate" and "number of recordings". If invalid, value of recording time is used.

P4	Recording time
Data range	1 to 8640000000 Specify each recording time in unit of millisecond.
Remarks	Range of recording time varies by remaining capacity, "sampling rate" and "number of recordings". Maximum recording time is 100 days. If recording time beyond the maximum time is specified, it becomes error.

Parameters

P1	Management of memory recording
Data range	0 to 2 0 : Memory recording OFF 1 : Memory recording ON Overwrite mode OFF 2 : Memory recording ON Overwrite mode ON

P2	Sampling speed of memory recording
Data range	0 to 25
Remarks	Refer to " Table of sampling speed " concerning of relationship between parameter number and sampling speed.

P3	(Internal reservation)
Data range	Omit always

P4	Number of recorded blocks (number of memory divisions)
Data range	1 to 200

P5	Block size of memory recording (number of points)
Data range	0 to 18 0 : 2 k 1 : 5 k 2 : 10 k 3 : 20 k 4 : 50 k 5 : 100 k 6 : 200 k 7 : 500 k 8 : 1 M 9 : 2 M 10 : 5 M 11 : 10 M 12 : 20 M 13 : 50 M 14 : 100 M 15 : 200 M 16 : 500 M 17 : 1 G 18 : 2 G Unit is number of points
Remarks	Block size is number of recording data for each channel.

P6	Pre-trigger
Data range	0 to 99

P7	(Internal reservation)
Data range	Omit always

P8	Synchronization control trigger for monitor
Data range	0 or 1 0 : Disabled 1 : Enabled

Table of sampling speed for memory recording

P2	Sampling
0	6 s
1	3 s
2	1.2 s
3	1 s
4	500 ms
5	200 ms
6	100 ms

P2	Sampling
7	50 ms
8	20 ms
9	10 ms
10	5 ms
11	2 ms
12	1 ms
13	500 μs

P2	Sampling
14	200 μs
15	100 μs
16	50 μs
17	20 μs
18	10 μs
19	5 μs
20	2 μs

P2	Sampling
21	1 μs
22	500 ns
23	200 ns
24	100 ns
25	50 ns

3.1.3. S03: SSD recording configuration and querying

Command	S03
Command message	Setting: S03 <P1>,<P2>,<P3>,<P4> Query: S03?
Response message	Setting: ACK S03 Query: ACK S03?,<P1>,<P2>,<P3>,<P4>
Remarks	Configures settings or submits a query regarding SSD recording. Refer to " Setup Details " - " Recording " in the instruction manual of the RA3100.

Parameters

P1	Management of SSD recording
Data range	0 or 1 0 : OFF 1 : ON
Remarks	When SSD recording is used, settings of trigger window of recording mode can use.

P2	Sampling speed of SSD recording
Data range	0 to 21, 63
Remarks	Range of sampling speed depends on Normal / P-P of data format. Refer to " Table of sampling speed for SSD recording " concerning of sampling speed.

P3	(Internal reservation)
Data range	Omit always

P4	Data format
Data range	0 or 1 0 : NORMAL data format 1 : P-P data format

Table of sampling speed for SSD recording

P2	Sampling	Data format	
		NORMAL	P-P
0	6 s	○	○
1	3 s	○	○
2	1.2 s	○	○
3	1 s	○	○
4	500 ms	○	○
5	200 ms	○	○
6	100 ms	○	○
7	50 ms	○	○
8	20 ms	○	○
9	10 ms	○	○
10	5 ms	○	○

P2	Sampling	Data format	
		NORMAL	P-P
11	2 ms	○	○
12	1 ms	○	○
13	500 μs	○	○
14	200 μs	○	○
15	100 μs	○	○
16	50 μs	○	○
17	20 μs	○	○
18	10 μs	○	○
19	5 μs	○	○
20	2 μs	○	○
21	1 μs	○	✕
63	EXT	○	○

3.1.5. S21: Start-trigger configuration and querying (analog input signal)

Command	S21
Command message	Setting: S21 <P1>,<P2>, . . . ,<P7> Query: S21?
Response message	Setting: ACK S21 Query: ACK S21?,<P1>,<P2>, . . . ,<P7>
Remarks	Configures settings or submits a query regarding the start-trigger when the trigger source is analog input. Refer to " Trigger Setup " - " Start Trigger " in the instruction manual of the RA3100.

Parameters

P1	Management of start trigger (Analog input channel)
Data range	0 or 1 0 : Invalid 1 : Effective

P2	Slot number
Data range	1 to 9
Remarks	Input slot number of channel to set as start-trigger source

P3	Channel number
Data range	1 to 4
Remarks	Channel number of channel to set as trigger source

P4	Threshold value (upper threshold value) of window trigger
Data range	-32000 to 32000
Remarks	The parameter value is expressed as an AD count value. For information on the AD count value, refer to " Appendix " - " Relationship between AD Count Value and Measured Value " in the instruction manual of the RA3100. Trigger source has exceeded upper threshold value when using WINDOW (IN/OUT). Specify value more than lower threshold value when using WINDOW (IN/OUT). Specify the same threshold value when using UP and DOWN. For cautions when the scale conversion function and wave inversion function are enabled, refer to " 5.2. Cautions when using the scale conversion function and wave inversion function ".

P5	Threshold value (lower threshold value) of window trigger
Data range	-32000 to 32000
Remarks	The parameter value is expressed as an AD count value. For information on the AD count value, refer to " Appendix " - " Relationship between AD Count Value and Measured Value " in the instruction manual of the RA3100. Trigger source has been below threshold value when using UP and DOWN. Trigger source has been below lower threshold value when using WINDOW (IN/OUT). Specify value less than upper threshold value when using WINDOW (IN/OUT). For cautions when the scale conversion function and wave inversion function are enabled, refer to " 5.2. Cautions when using the scale conversion function and wave inversion function ".

3.1.8. S25: Memory-trigger configuration and querying (logical input signal)

Command	S25
Command message	Setting: S25 <P1>,<P2>, . . . ,<P8> Query: S25? <P1>
Response message	Setting: ACK S25 Query: ACK S25?,<P1>,<P2>, . . . ,<P8>
Remarks	Configures settings or submits a query regarding the trigger when the trigger source is logical input. Refer to "Trigger Setup" - "Memory trigger" in the instruction manual of the RA3100.

Parameters

P1	Trigger source
Data range	1 to 18 1 : T1 2 : T2 . . . 18 : T18 Selection of source
Remarks	Specifies the target trigger source.

P2	Management of trigger source
Data range	0 or 1 0 : Invalid 1 : Effective

P3	Slot number
Data range	1 to 9
Remarks	Input slot number of channel to set as trigger source

P4	Channel number
Data range	A, B A : CHA B : CHB
Remarks	Channel number of channel to set as trigger source

P5	Logic channel
Data range	0 to 255
Remarks	Channel to use for trigger detection A parameter value is summed up values of CHn to be used trigger input. CH1 : 1 CH2 : 2 CH3 : 4 CH4 : 8 CH5 : 16 CH6 : 32 CH7 : 64 CH8 : 128

P6	Bit pattern
Data range	0 to 255
Remarks	H/L trigger detection for each channel A parameter value is summed up values of CHn that detects trigger at H level. CH1 : 1 CH2 : 2 CH3 : 4 CH4 : 8 CH5 : 16 CH6 : 32 CH7 : 64 CH8 : 128

P7	Trigger detection
Data range	0 to 1 0 : OR 1 : AND
Remarks	Specify trigger detection either OR or AND for each channel of CH1 to CH8.

P8	Filter time
Data range	1 to 10000000 (10 s) Specify it in unit of s
Remarks	Filter time is the same as filter time of analog start trigger.

3.1.9. S26: Memory-trigger mode configuration and querying

Command	S26
Command message	Setting: S26 <P1> Query: S26?
Response message	Setting: ACK S26 Query: ACK S26?,<P1>

Parameters

P1	Trigger mode
Data range	0 to 2 0 : OFF 1 : OR 2 : AND
Remarks	OFF : Memory-trigger mode is disabled. OR : In the case of OR, it acts as a trigger when one of the valid trigger sources is detected. AND : In the case of AND, it acts as a trigger when all valid trigger sources are detected. Refer to " Trigger Setup " – " Memory trigger " in the instruction manual of the RA3100.

3.1.10. S30: Channel format configuration and querying

Command	S30
Command message	Setting: S30 <P1>,<P2>, . . . ,<P12> Query: S30? <P1>,<P2>
Response message	Setting: ACK S30 Query: ACK S30?,<P1>,<P2>, . . . ,<P12>
Remarks	Refer to " Using Optional Modules " – " 2ch Voltage Module (RA30-101) " in the instruction manual of the RA3100.

Parameters

P1	Slot selection
Data range	1 to 9, F
Remarks	Specify slot number that the target module is installed. If F is specified, all modules are target.

P2	Channel selection
Data range	1 to 9, F 16 Channel Logic Module (RA30-105) 1 : CHA 2 : CHB, F
Remarks	Specify target channel. If F is specified, all channels of modules specified with P1 are target.

P3	Signal name
Data range	Enter a string. Maximum 40 characters, encoded in UTF-8.
Remarks	Insert strings between <STX> [0x02] and <ETX> [0x03].

P4	Color
Data range	1 to 18 1 : Light blue 2 : Pink 3 : Yellow 4 : White 5 : Light green 6 : Purple 7 : Blue 8 : Light yellow-green 9 : Red 10 : Dark gray 11 : Reddish purple 12 : Bright blue 13 : Olive green 14 : Pale yellow-green 15 : Orange 16 : Pale purple 17 : Pale pink 18 : Green
Remarks	When logic module is used, 8 CH of CHA and CAB become the same color.

P5	Display position
Data range	0.0 to 100.0

P6	Display range
Data range	1.0 to 100.0

P7	Display minimum
Data range	-RANGE to RANGE
Remarks	A display error may occur due to resolution between settings and input value. Example : S30 1,1,,,,,-100,30,1,,

P8	Display maximum
Data range	-RANGE to RANGE
Remarks	A display error may occur due to resolution between settings and input value. (Input example) S30 1,1,,,,,-100,30,1,,

P9	Sheet number
Data range	1 to 3
Remarks	The operation when this is set is as follows. * When specified channel is OFF, NAK is responded. * When specified sheets exceed 48 CH or more, NAK is responded. * When slot or channel is F, even if channel is OFF or sheets exceed 48 CH or more, ACK is responded. (Settings are not reflected.)

3.1.12. S32: Scale conversion configuration and querying

Command	S32
Command message	Setting: S32 <P1>,<P2>, . . . ,<P10> Query: S32? <P1>,<P2>
Response message	Setting: ACK S32 Query: ACK S32?, <P1>,<P2>, . . . ,<P10>
Remarks	Refer to " Setup Details " - " Conversion (Physical Quantity Conversion) " in the instruction manual of the RA3100.

Parameters

P1	Slot selection
Data range	Setting: 1 to 9, F Query: 1 to 9
Remarks	Specify slot number that the target module is installed. If F is specified, all modules are target.

P2	Channel selection
Data range	Setting: 1 to 4, F Query: 1 to 4
Remarks	Specify channel of module specified with P1. If F is specified, all channels of modules specified with P1 are target.

P3	Conversion method
Data range	0 to 2 0 : Not used 1 : compensation 2 : 2 points
Remarks	Refer to the instruction manual of the RA3100.

P4	Compensation : Gain
Data range	-7.922816E+10 to 7.922816E+10
Remarks	Gain when "1: Compensation" is selected for conversion method in P3

P5	Compensation : Offset
Data range	-7.922816E+10 to 7.922816E+10
Remarks	Offset when "1: Compensation" is selected for conversion method in P3

P6	2 points : Pre-conversion 1
Data range	-7.922816E+10 to 7.922816E+10
Remarks	Value of pre-conversion 1 when "2: 2 points" is selected for conversion method in P3

P7	2 points : Post-conversion 1
Data range	-7.922816E+10 to 7.922816E+10
Remarks	Value of post-conversion 1 when "2: 2 points" is selected for conversion method in P3

P8	2 points : Pre-conversion 2
Data range	-7.922816E+10 to 7.922816E+10
Remarks	Value of pre-conversion 2 when "2: 2 points" is selected for conversion method in P3

P9	2 points : Post-conversion 2
Data range	-7.922816E+10 to 7.922816E+10
Remarks	Value of post-conversion 2 when "2: 2 points" is selected for conversion method in P3

P10	Unit
Data range	0 to 11
Remarks	Specify unit from unit list. 0 is default unit of module.

3.1.13. S33: Unit list configuration and querying

Command	S33
Command message	Setting: S33 <P1>,<P2>, •••,<P11> Query: S33?
Response message	Setting: ACK S33 Query: ACK S33?, <P1>,<P2>, •••,<P11>
Remarks	Insert strings between <STX> [0x02] and <ETX> [0x03]. Refer to " Setup Details " - " Conversion (Physical Quantity Conversion) " in the instruction manual of the RA3100.

Parameters

P1	Unit 1
Data range	Enter a string. Maximum 10 characters, encoded in UTF-8.

P2	Unit 2
Data range	Enter a string. Maximum 10 characters, encoded in UTF-8.

– Abbreviation –

P11	Unit 11
Data range	Enter a string. Maximum 10 characters, encoded in UTF-8.

3.1.16. S36: Print parameter configuration and querying

Command	S36
Command message	Setting: S36 <P1>,<P2>, ••• ,<P12> Query: S36?
Response message	Setting: ACK S36 Query: ACK S36?, <P1>,<P2>, ••• ,<P12>
Remarks	Configures settings or submits a query to the printer regarding the print parameters. Refer to " Setup Details " - " Printer " in the instruction manual of the RA3100.

Parameters

P1	Header
Data range	0 to 3 0 : OFF 1 : Text 2 : Signal name 3 : Text & signal name

P2	Annotation
Data range	0 to 1 0 : OFF 1 : Text

P3	Footer
Data range	0 to 3 0 : OFF 1 : Text 2 : Scale value 3 : Text & scale value

P4	Grid
Data range	0 to 4 0 : OFF 1 : 10 mm STD 2 : 10 mm 3 : 5 mm STD 4 : 5 mm

P5	Date / data name
Data range	0 to 3 0 : OFF 1 : Date 2 : Recording name 3 : Date & recording name

P6	Line number of date / data name
Data range	1 to 86

P7	Trigger / mark
Data range	0 to 1 0 : OFF 1 : ON

P8	Line number of trigger / mark
Data range	1 to 86

P9	Time axis
Data range	0 to 1 0 : OFF 1 : ON

P10	Line number of time axis
Data range	1 to 86

P11	Recording speed
Data range	0 to 2 0 : OFF 1 : Sampling speed 2 : Chart speed

P12	Line number of recording speed
Data range	1 to 86

3.1.17. S37: Header, footer, and annotation configuration and querying

Command	S37
Command message	Setting: S37 <P1>,<P2>,<P3> Query: S37? <P1>,<P2>
Response message	Setting: ACK S37 Query: ACK S37?,<P1>,<P2>,<P3>
Remarks	Configures settings or submits a query regarding the printed text. Refer to " Setup Details " - " Printer " in the instruction manual of the RA3100. Header, footer and annotation can print using command of " 3.4.4. E16: Execute print header, footer and annotation ".

Parameters

P1	Type of this text
Data range	0 to 2 0 : Header 1 : Annotation 2 : Footer
Remarks	Specifies the target.

P2	Line number
Data range	1 to 86
Remarks	Specifies the target line number.

P3	Text
Data range	Enter a string. Maximum 60 characters, encoded in UTF-8.
Remarks	Insert strings between <STX> [0x02] and <ETX> [0x03]. Use characters of UTF-8 code.

Example of command input : Annotation text is printed at 10th line.

S37 1,10,<STX>Title:<ETX>

3.1.18. S39: Y-T waveform format configuration and querying

Command	S39
Command message	Setting: S39 <P1>,<P2>,<P3>, . . . ,<P7> Query: S39?
Response message	Setting: ACK S39 Query: ACK S39?, <P1>,<P2>,<P3>, . . . ,<P7>
Remarks	Configures settings or submits a query regarding the Y-T waveform displayed on the monitor. Refer to " Setup Details " - " Display Setup " in the instruction manual of the RA3100.

Parameters

P1	Grid
Data range	0 to 2 0 : OFF 1 : Dark 2 : Bright

P2	Trigger
Data range	0 to 1 0 : OFF 1 : ON

P3	Mark
Data range	0 to 1 0 : OFF 1 : ON

P4	Interlocked waveform to cursor position
Data range	0 to 1 0 : OFF 1 : ON

P5	Search result line
Data range	0 to 1 0 : OFF 1 : ON

P6	Notation of X axis
Data range	0 to 2 0 : OFF 1 : date 2 : Point

P7	TSP/BSP
Data range	0 to 1 0 : OFF 1 : ON

3.1.19. S40: X–Y waveform configuration and querying

Command	S40
Command message	Setting: S40 <P1>,<P2>,<P3> Query: S40?
Response message	Setting: ACK S40 Query: ACK S40?, <P1>,<P2>,<P3>
Remarks	Configures settings or submits a query regarding X-Y waveform display. Refer to "Playback Recorded Data" - "X–Y Waveform" in the instruction manual of the RA3100.

Parameters

P1	Dot/Line switching
Data range	0 to 1 0 : Dot 1 : Line

P2	Grid display
Data range	0 to 1 0 : OFF 1 : ON

P3	Display scale
Data range	1 to 4 1 : X-Y1 2 : X-Y2 3 : X-Y3 4 : X-Y4

3.1.20. S41: X–Y waveform channel configuration and querying

Syntax	S41
Command message	Setting: S41 <P1>,<P2>, . . . ,<P5> Query: S41? <P1>
Response message	Setting: ACK S41 Query: ACK S41?, <P1>,<P2>, . . . ,<P5>
Remarks	Configures settings or submits a query regarding the input channels for the X axis and Y axis of the X-Y waveform. Refer to "Playback Recorded Data" - "X–Y Waveform" in the instruction manual of the RA3100.

Parameters

P1	X–Y channel
Data range	1 to 4
Remarks	Specify target X-Y channel.

P2	Slot number of Z axis channel
Data range	1 to 9

P3	Input channel of X axis
Data range	1 to 4
Remarks	Same channel as Y axis cannot be selected.

3.Details of command – 3.1.Settings of main unit (S commands)

P6	Analysis 1 : Analysis function					
Data range	0 to 9	0 : Time scale waveform	1 : Linear spectrum	2 : RMS spectrum	3 : Power spectrum	4 : Power spectrum density
		5 : 1/1 octave analysis	6 : 1/3 octave analysis	7 : Cross power spectrum	8 : Transfer function	9 : Coherence function
P7	Analysis 1 : X axis					
Data range	0 to 4	0 : Time	1 : Linear Hz	2 : Log Hz	3 : 1/1 Oct	4 : 1/3 Oct
P8	Analysis 1 : Y axis					
Data range	0 to 5	0 : Linear	1 : Lin-Rel	2 : Lin-Img	3 : Lin-Amp	4 : Log-Amp
			5 : Phase			
P9	Analysis 1 : Manual scale					
Data range	0 to 1	0 : OFF	1 : ON			
P10	Analysis 1 : Maximum value of manual scale					
Data range	-7.922816E+28 ~ 7.922816E+28					
P11	Analysis 1 : Minimum value of manual scale					
Data range	-7.922816E+28 ~ 7.922816E+28					
P12	Analysis 1 : Slot number of signal analysis CH1					
Data range	0 to 9					
P13	Analysis 1 : Channel of signal analysis CH1					
Data range	0 to 4					
P14	Analysis 1 : Slot number of signal analysis CH2					
Data range	0 to 9					
P15	Analysis 1 : Channel of signal analysis CH2					
Data range	0 to 4					
P16	Analysis 1 : Peak value					
Data range	0 to 1	0 : Maximum value	1 : Local maximum value			
P17	Analysis 2 : Analysis function					
Data range	0 to 9	0 : Time scale waveform	1 : Linear spectrum	2 : RMS spectrum	3 : Power spectrum	4 : Power spectrum density
		5 : 1/1 octave analysis	6 : 1/3 octave analysis	7 : Cross power spectrum	8 : Transfer function	9 : Coherence function

Number	1	2	3	4	5	6	7	8	9
Number of lines of graph	P3	P6	P9	P12	P15	P18	P21	P24	P27
Grid display	P4	P7	P10	P13	P16	P19	P22	P25	P28
Number of space lines	P5	P8	P11	P14	P17	P20	P23	P26	P29

Number	10	11	12	13	14	15	16	17	18
Number of lines of graph	P30	P33	P36	P39	P42	P45	P48	P51	P54
Grid display	P31	P34	P37	P40	P43	P46	P49	P52	P55
Number of space lines	P32	P35	P38	P41	P44	P47	P50	P53	

3.1.23. S44: Feed length configuration and querying

Command	S44
Command message	Setting: S44 <P1> Query: S44?
Response message	Setting: ACK S44 Query: ACK S44?,<P1>
Remarks	Configures settings or submits a query regarding the feed length. Refer to " Setup Details " – " Printer " in the instruction manual of the RA3100.

Parameter

P1	Feed length
Data range	0 to 100
Remarks	Feed length after printing (mm)

3.1.26. S48: Measurement mode configuration and querying

Command	S48
Command message	Setting: S48 <P1> Query: S48?
Response message	Setting: ACK S48 Query: ACK S48?,<P1>
Remarks	Configures settings or submits a query regarding the measurement mode. Refer to " Measurement Setup " – " Selecting the Measurement Mode " in the instruction manual of the RA3100.

Parameter

P1	Measurement mode
Data range	0 to 1 0: R&D mode 1: MFG mode

3.1.27. S49: TRIG key function configuration and querying

Command	S49
Command message	Setting: S49 <P1> Query: S49?
Response message	Setting: ACK S49 Query: ACK S49?,<P1>
Remarks	Performs assignment or submits a query regarding the operation panel TRIG key. Refer to " Setup Details " – " Other (Main Unit Setup) " in the instruction manual of the RA3100.

Parameter

P1	TRIG key assignment function
Data range	0 to 1 0: TRIG 1: FEED

3.1.28. S50: Data transfer configuration and querying

Command	S50
Command message	Setting: S50 <P1>,<P2>, ••• ,<P9> Query: S50?
Response message	Setting: ACK S50 Query: ACK S50?,<P1>,<P2>, ••• ,<P9>
Remarks	Configures settings or submits a query regarding data transfer. Refer to " Setup Details " – " Data Transfer " in the instruction manual of the RA3100.

Parameters

P1	Data transfer ON/OFF
Data range	0 to 1 0: OFF 1: ON

P2	Transfer mode
Data range	0 to 2 0: Always 1: When recording 2: Manual
Remarks	Can only be changed when data transfer (P1) is set to OFF

P3	Data type
Data range	0 to 1 0: PRINTER 1: SSD
Remarks	Can only be changed when data transfer (P1) is set to OFF

P4	Protocol
Data range	0 to 1 0: TCP 1: UDP
Remarks	Can only be changed when data transfer (P1) is set to OFF

P5	UDP destination IP address
Data range	IP address (four numbers separated by dots) (Example) 192.168.0.2
Remarks	Can only be changed when data transfer (P1) is set to OFF

P6	UDP destination port
Data range	0 to 65535
Remarks	Can only be changed when data transfer (P1) is set to OFF

P7	Transfer data
Data range	0 to 1 0: One-shot 1: Continuous
Remarks	Can only be changed when data transfer (P1) is set to OFF

P8	Decimation
Data range	1 to 1000
Remarks	Can only be changed when data transfer (P1) is set to OFF

P9	Time stamp
Data range	0 to 1 0: OFF 1: ON
Remarks	Can only be changed when data transfer (P1) is set to OFF

3.1.29. S51: Date and time configuration and querying

Command	S51
Command message	Setting: S51 <P1>,<P2>,...,<P6> Query: S51?
Response message	Setting: ACK S51 Query: ACK S51?,<P1>,<P2>,...,<P6>
Remarks	Configures or submits a query on the date and time of the main unit. P1, P2, and P3 (for the date) or P4, P5, and P6 (for the time) must be set together. To set the date or time only, abbreviate using commas. Example of setting the date only: S51 2024,1,1,,,

Parameters

P1	Year of date
Data range	2000 to 2099

P2	Month of date
Data range	1 to 12

P3	Day of date
Data range	1 to 31

P4	Hour of time
Data range	0 to 23

P5	Minute of time
Data range	0 to 59

P6	Second of time
Data range	0 to 59

3.1.30. S52 : CSV format configuration and querying

Command	S52
Command message	Setting: S52 <P1>,<P2>,...,<P7> Query: S52?
Response message	Setting: ACK S52 Query: ACK S52?,<P1>,<P2>,...,<P7>
Remarks	Configures whether to output header information to the CSV data. Refer to " Main Unit Setup " - " Other " - " CSV Format " in the instruction manual of the RA3100.

Parameters

P1	Header information
Data range	0 to 1 0: OFF 1: ON
Remarks	Configures whether to output header information to the CSV data.

P2	Maximum data output per file
Data range	0 to 1 0: 60k 1: 1M
Remarks	Set the maximum sample count to output per file.

P3	Separator symbol
Data range	0 to 3 0: comma 1: semicolon 2: space 3: tab
Remarks	Set the symbol to use for separating the items of the CSV data.

P4	Decimal point symbol
Data range	0 to 1 0: period 1: comma
Remarks	Set the symbol to use for decimal points in the numeric values of the CSV data.

P5	External sampling X axis unit conversion
Data range	0 to 1 0: OFF 1: ON
Remarks	Set whether to perform X axis unit conversion for external sampling.

P6	External sampling ΔX
Data range	1E-12 to 7.922816E+10
Remarks	Set the amount of change in the X axis for external sampling when P5 is set to "1".

P7	External sampling X axis unit
Data range	Enter a string. Maximum 10 characters, encoded in UTF-8.
Remarks	Set the unit of the X axis for external sampling when P5 is set to "1". Enclose the string between <STX> [0x02] and <ETX> [0x03]. Example: <STX>V<ETX>

P8	CAL value
Data range	1 to 9999
Remarks	The unit of the parameter value is 10^{-6} strain. For cautions when the scale conversion function is enabled, refer to " 5.2. Cautions when using the scale conversion function and wave inversion function ".

P9	R-FINE
Data range	-8000.0 to 8000.0
Remarks	The unit of the parameter value is 10^{-6} strain. For cautions when the scale conversion function and wave inversion function are enabled, refer to " 5.2. Cautions when using the scale conversion function and wave inversion function ".

P10	B.V.
Data range	0 to 1 0: 0.5 Vrms 1: 2 Vrms

3.2.5. M05: RA30-105 (16ch logic module) configuration and querying

Command	M05
Command message	Setting: M05 <P1>,<P2>, . . . ,<P6> Query: M05? <P1>,<P2>
Response message	Setting: ACK M05 Query: ACK M05?, <P1>,<P2>, . . . ,<P6>
Remarks	Configures settings or submits a query regarding the RA30-105. Refer to "Using Optional Modules" - "16ch Logic Module (RA30-105)" in the instruction manual of the RA3100.

Parameters

P1	Slot number
Data range	Setting: 1 to 9, F Query: 1 to 9
Remarks	Specify slot number that the target module is installed. When F is selected, all modules of the same type are target.

P2	Channel
Data range	Setting: A, B, F Query: A, B
Remarks	Specify channel of target module. When F is selected, all channels are target. When A is selected, CHA (1 to 8 CH) are target. When B is selected, CHB (9 to 16 CH) are target.

P3	Measurement ON/OFF
Data range	0 to 1 0 : OFF 1 : ON

P4	Input signal
Data range	0 to 1 0 : Voltage 1 : Contact

P5	Voltage threshold value
Data range	0 to 2 0 : 1.4 V 1 : 2.5 V 2 : 4.0 V

P6	Resistance threshold value
Data range	0 to 2 0 : 2 k Ω 1 : 5 k Ω 2 : 9 k Ω

3.2.6. M06: RA30-106 (2ch temperature module) configuration and querying

Command	M06
Command message	Setting: M06 <P1>,<P2>, . . . ,<P11> Query: M06? <P1>,<P2>
Response message	Setting: ACK M06 Query: ACK M06?, <P1>,<P2>, . . . ,<P11>
Remarks	Configures settings or submits a query regarding the RA30-106. Refer to "Using Optional Modules" - "2ch Temperature Module (RA30-106)" in the instruction manual of the RA3100.

Parameters

P1	Slot number
Data range	Setting: 1 to 9, F Query: 1 to 9
Remarks	Specify slot number that the target module is installed. When F is selected, all modules of the same type are target.

P2	Channel
Data range	Setting: 1 to 2, F Query: 1 to 2
Remarks	Specify channel of target module. When F is selected, all channels are target.

P3	Measurement ON/OFF
Data range	0 to 1 0 : OFF 1 : ON

P4	Data refresh rate
Data range	0 to 2 0 : Slow 1 : Normal 2 : Fast

P5	Sensor
Data range	0 to 1 0 : Thermocouple (TC) 1 : Resistance temperature detector (RTD)

P6	TC : Measurement range
Data range	0 to 2 0 : High resolution 1 : Middle resolution 2 : Low resolution
Remarks	Refer to "Table of sensor type and measurement range" concerning the relationship between the TC sensor type (P7) and measurement range.

P7	TC : Sensor type
Data range	0 to 8 0 : K 1 : J 2 : E 3 : T 4 : N 5 : R 6 : S 7 : B 8 : C

P8	TC : Reference junction
Data range	0 to 1 0 : External 1 : Internal
Remarks	Reference junction (cooling point) for temperature compensation of thermocouple

3.2.7. M07: RA30–107 (2ch high voltage module) configuration and querying

Command	M07
Command message	Setting: M07 <P1>,<P2>, •••,<P7> Query: M07? <P1>,<P2>
Response message	Setting: ACK M07 Query: ACK M07?, <P1>,<P2>, •••,<P7>
Remarks	Configures settings or submits a query regarding the RA30-107. Refer to "Using Optional Modules" – "2ch High Voltage Module (RA30–107)" in the instruction manual of the RA3100.

Parameter

P1	Slot
Data range	Setting: 1 to 9, F Query: 1 to 9
Remarks	Specifies the slot where the target module is installed. When "F" is specified, all modules of the same type are targeted.

P2	Channel
Data range	Setting: 1 to 2, F Query: 1 to 2
Remarks	Specifies the channel of the target module. When "F" is specified, all channels are targeted.

P3	Measurement ON/OFF
Data range	0 to 1 0: OFF 1: ON

P4	Measurement range																														
Data range	<table border="1"> <tr> <td>Measurement mode</td> <td>0 to 8</td> <td>0 : 1000 V</td> <td>1 : 500 V</td> <td>2 : 200 V</td> </tr> <tr> <td>DC</td> <td></td> <td>3 : 100 V</td> <td>4 : 50 V</td> <td>5 : 20 V</td> </tr> <tr> <td></td> <td></td> <td>6 : 10 V</td> <td>7 : 5 V</td> <td>8 : 2 V</td> </tr> <tr> <td>Measurement mode</td> <td>0 to 8</td> <td>0 : 1000 Vrms</td> <td>1 : 500 Vrms</td> <td>2 : 200 Vrms</td> </tr> <tr> <td>RMS</td> <td></td> <td>3 : 100 Vrms</td> <td>4 : 50 Vrms</td> <td>5 : 20 Vrms</td> </tr> <tr> <td></td> <td></td> <td>6 : 10 Vrms</td> <td>7 : 5 Vrms</td> <td>8 : 2 Vrms</td> </tr> </table>	Measurement mode	0 to 8	0 : 1000 V	1 : 500 V	2 : 200 V	DC		3 : 100 V	4 : 50 V	5 : 20 V			6 : 10 V	7 : 5 V	8 : 2 V	Measurement mode	0 to 8	0 : 1000 Vrms	1 : 500 Vrms	2 : 200 Vrms	RMS		3 : 100 Vrms	4 : 50 Vrms	5 : 20 Vrms			6 : 10 Vrms	7 : 5 Vrms	8 : 2 Vrms
Measurement mode	0 to 8	0 : 1000 V	1 : 500 V	2 : 200 V																											
DC		3 : 100 V	4 : 50 V	5 : 20 V																											
		6 : 10 V	7 : 5 V	8 : 2 V																											
Measurement mode	0 to 8	0 : 1000 Vrms	1 : 500 Vrms	2 : 200 Vrms																											
RMS		3 : 100 Vrms	4 : 50 Vrms	5 : 20 Vrms																											
		6 : 10 Vrms	7 : 5 Vrms	8 : 2 Vrms																											
Remarks	The items vary according to the measurement mode setting in P7.																														

P5	Coupling
Data range	0 to 2 0: GND 1: DC 2: AC

P6	Low-pass filter
Data range	0 to 5 0: OFF 1: 3 Hz 2: 30 Hz 3: 300 Hz 4: 3 kHz 5: 30 kHz

P7	Measurement mode
Data range	0 to 3 0: DC 1: RMS (Fast) 2: RMS (Mid) 3: RMS (Slow)
Remarks	Must be specified together with the measurement range in P4. An NAK message is returned if it is not specified.

3.2.8. M08: RA30–108 (2ch frequency module) configuration and querying

Command	M08
Command message	Setting: M08 <P1>,<P2>,...,<P11> * The parameters vary according to the measurement mode. Query: M08? <P1>,<P2>
Response message	Setting: ACK M08 Query: ACK M08?,<P1>,<P2>,...,<P11> * The parameters vary according to the measurement mode.
Remarks	Configures settings or submits a query regarding the RA30–108. Refer to "Using Optional Modules" – "2ch Frequency Module (RA30–108)" in the instruction manual of the RA3100. For information on the relationship between the measurement mode and parameters, refer to "Table of parameters for each measurement mode".

Table of parameters for each measurement mode

Channel	CH1 / CH2						CH3 / CH4
Measurement mode	Period/ Frequency/ Power freq.	Rotation speed	Pulse width/ Duty cycle	Freq. deviation	Pulse count	Pulse integ.	Input voltage
P1	Slot						
P2	Channel						
P3	Measurement						
P4	Measurement range						
P5	Measurement mode						Coupling
P6	Response speed						L.P.F.
P7	Smoothing process				Pulse polarity		Threshold
P8	Smoothing count				Gate time	Auto reset	Hysteresis
P9	Pulse average process						
P10	Pulse average count						
P11		Pulses per revolution	Pulse polarity	Center frequency			

CH1/CH2 parameters

P1	Slot
Data range	Setting: 1 to 9, F Query: 1 to 9
Remarks	Specifies the slot where the target module is installed. When "F" is specified, all modules of the same type are targeted.

P2	Channel
Data range	1 to 2
Remarks	Specifies the channel of the target module.

P3	Measurement ON/OFF
----	--------------------

3.Details of command – 3.2.Module setting (M commands)

Data range	0 to 1	0 : OFF	1 : ON
------------	--------	---------	--------

P4		Measurement range				
Data range	Measurement mode Period/pulse width	0 to 15	0 : 1 ms	1 : 2 ms	2 : 5 ms	
			3 : 10 ms	4 : 20 ms	5 : 50 ms	
			6 : 100 ms	7 : 200 ms	8 : 500 ms	
			9 : 1 s	10 : 2 s	11 : 5 ms	
			12 : 10 s	13 : 20 s	14 : 50 s	
			15 : 100 s			
	Measurement mode Frequency		0 to 15	0 : 2 Hz	1 : 5 Hz	2 : 10 Hz
				3 : 20 Hz	4 : 50 Hz	5 : 100 Hz
	6 : 200 Hz	7 : 500 Hz		8 : 1 kHz		
	9 : 2 kHz	10 : 5 kHz		11 : 10 kHz		
	12 : 20 kHz	13 : 50 kHz		14 : 100 kHz		
	15 : 200 kHz					
Measurement mode Rotation speed	0 to 15	0 : 10 rpm		1 : 20 rpm	2 : 50 rpm	
		3 : 100 rpm		4 : 200 rpm	5 : 500 rpm	
		6 : 1000 rpm	7 : 2000 rpm	8 : 5000 rpm		
		9 : 10000 rpm	10 : 20000 rpm	11 : 50000 rpm		
		12 : 100 krpm	13 : 200 krpm	14 : 500 krpm		
		15 : 1000 krpm				
Measurement mode Duty cycle		0 to 3	0 : 100 % (20 Hz)	1 : 100 % (200 Hz)		
			2 : 100 % (2 kHz)	3 : 100 % (20 kHz)		
Measurement mode Power freq.	0 to 2	0 : 50 Hz	1 : 60 Hz	2 : 400 Hz		
Measurement mode Freq. deviation	Fixed to 0	0: ±50%				
Measurement mode Pulse count	Fixed to 0	0: 40000				
Measurement mode Pulse integ.	0 to 14	0 : 50 k	1 : 100 k	2 : 200 k		
		3 : 500 k	4 : 1 M	5 : 2 M		
		6 : 5 M	7 : 10 M	8 : 20 M		
		9 : 50 M	10 : 100 M	11 : 200 M		
		12 : 500 M	13 : 1000 M	14 : 2000 M		

Remarks The data ranges and items vary according to the measurement mode setting in P5.

P5		Measurement mode			
Data range	0 to 8	0: Period	1: Frequency	2: Rotation speed	
		3: Pulse width	4: Duty cycle	5: Power freq.	
		6: Freq. deviation	7: Pulse count	8: Pulse integ.	

P6	Response speed
----	----------------

3.Details of command – 3.2.Module setting (M commands)

Data range	0 to 1000
------------	-----------

P7	Smoothing process, pulse polarity			
Data range	Smoothing process	0 to 1	0 : OFF	1 : ON
	Pulse polarity	0 to 1	0 : Positive	1 : Negative

P8	Smoothing count, gate time, auto reset			
Data range	Smoothing count	2 to 100		
	Gate time	0 to 8	0 : 200 ms	1 : 500 ms
			2 : 1 s	3 : 2 s
Auto reset	0 to 3	0 : OFF	1 : Start	2 : Over
			3 : Start & Over	8 : 60 s

P9	Pulse average process		
Data range	0 to 1	0 : OFF	1 : ON

P10	Pulse average count		
Data range	2 to 4096		

P11	Pulses per revolution, pulse polarity, center frequency		
Data range	Pulses per revolution	1 to 100	
	Pulse polarity	0 to 1	0 : Positive
			1 : Negative
Center frequency	6.6 to 13000.0		

CH3/CH4 parameters

P1	Slot		
Data range	Setting:	1 to 9, F	
	Query:	1 to 9	
Remarks	Specifies the slot where the target module is installed. When "F" is specified, all modules of the same type are targeted.		

P2	Channel		
Data range	3 to 4		
Remarks	Specifies the channel of the target module.		

P3	Measurement ON/OFF		
Data range	0 to 1	0 : OFF	1 : ON

P4	Range					
Data range	0 to 8	0 : 500 V	1 : 200 V	2 : 100 V	3 : 50 V	4 : 20 V
		5 : 10 V	6 : 5 V	7 : 2 V	8 : 1 V	

P5	Coupling
Data range	0 to 2 0 : GND 1 : DC 2 : AC
P6	Low-pass filter (CH3/CH4)
Data range	0 to 3 0 : OFF 1 : 300 Hz 2 : 3 kHz 3 : 30 kHz
P7	Threshold
Data range	-40 to 40
Remarks	The parameter value is the ratio (%) to the measurement range in P4. (Example) Set this parameter to 10 to have a threshold voltage of 20 V with a measurement range of 200 V.
P8	Hysteresis
Data range	1 to 10

3.2.9. M09: RA30-109 (2ch acceleration module) configuration and querying

Command	M09
Command message	Setting: M09 <P1>,<P2>, •••,<P11> Query: M09?
Response message	Setting: ACK M09 Query: ACK M09?, <P1>,<P2>, •••,<P11>
Remarks	Configures settings or submits a query regarding the RA30-109. Refer to " Using Optional Modules " - " 2ch Acceleration Module (RA30-109) " in the instruction manual of the RA3100.

Parameter

P1	Slot
Data range	Setting: 1 to 9, F Query: 1 to 9
Remarks	Specifies the slot where the target module is installed. When "F" is specified, all modules of the same type are targeted.
P2	Channel
Data range	Setting: 1 to 2, F Query: 1 to 2
Remarks	Specifies the channel of the target module. When "F" is specified, all channels are targeted.
P3	Measurement ON/OFF
Data range	0 to 1 0 : OFF 1 : ON

3.2.10. M12: RA30-112 (remote control module) configuration and querying

Command	M12
Command message	Setting: M12 <P1>,<P2>, . . . ,<P8> Query: M12? <P1>
Response message	Setting: ACK M12 Query: ACK M12?,<P1>,<P2>, . . . ,<P8>
Remarks	Configures settings or submits a query regarding the RA30-112. Refer to "Using Optional Modules" - "Remote Control Module (RA30-112)" in the instruction manual of the RA3100.

Parameters

P1	Slot number
Data range	Setting: 1 to 9, F Query: 1 to 9
Remarks	The RA30-112 can only install slot 9. This parameter is shown the same P1 of other modules because of unified parameters.

P2	Response speed (filter time)
Data range	0 to 2 0 : Slow 1 : Normal 2 : Fast

P3	TRIG/EXT.1
Data range	0 to 1 0 : TRIG 1 : EXT.1
Remarks	When 1 : EXT.1 is used, the setting of P5 needs.

P4	Type of trigger signal
Data range	0 to 2 0 : OFF 1 : Start trigger 2 : Memory trigger

P5	EXT.1 output condition
Data range	0 to 7 [b0111] The calculation formula of the parameter is as follows: Parameter of bit 2 x 2 ² + Parameter of bit 1 x 2 ¹ + Parameter of bit 0 x 2 ⁰ bit 0 : System error bit 1 : Printer error bit 2 : Out of range When setting parameter to enable, set bit to 1. When setting parameter to invalid, set bit to 0.
Remarks	Example: How to output signal from TRIG/EXT.1 OUT terminal of RA30-112 : When outputting system error and printer error, set 3. When outputting printer error only, set 2. When the recorder is set only, even if system error occurs, it isn't outputted. Specify P3 to 1 : EXT.1.

P6	OSC/EXT.2
Data range	0 to 1 0 : OSC 1 : EXT.2
Remarks	When 1 : EXT.2 is used, the setting of P8 needs.

P7	Carrier signal source (OSC) for the AC strain module
Data range	0 to 1 0 : Internal clock 1 : External clock

P8	EXT.2 output condition
Data range	0 to 7 [b0111] The calculation formula of the parameter is as follows: Parameter of bit 2 $\times 2^2$ + Parameter of bit 1 $\times 2^1$ + Parameter of bit 0 $\times 2^0$ bit 0 : System error bit 1 : Printer error bit 2 : Out of range When setting parameter to enable, set bit to 1. When setting parameter to invalid, set bit to 0.
Remarks	Example: How to output signal from TRIG/EXT.2 OUT terminal of RA30–112 : When outputting system error and printer error, set 3. When outputting printer error only, set 2. When the recorder is set only, even if system error occurs, it isn't outputted. Specify P5 to 1 : EXT.2.

3.2.11. M13: RA30–113 (4ch voltage module) configuration and querying

Command	M13
Command message	Setting: M13 <P1>,<P2>, . . . ,<P6> Query: M13? <P1>,<P2>
Response message	Setting: ACK M13 Query: ACK M13?, <P1>,<P2>, . . . ,<P6>
Remarks	Configures settings or submits a query regarding the RA30-113. Refer to "Using Optional Modules" - "4ch Voltage Module (RA30–113)" in the instruction manual of the RA3100.

Parameters

P1	Slot number
Data range	Setting: 1 to 9, F Query: 1 to 9
Remarks	Specify slot number that the target module is installed. When F is selected, all modules of the same type are target.

P2	Channel
Data range	Setting: 1 to 4, F Query: 1 to 4
Remarks	Specify channel of target module. When F is selected, all channels are target.

P3	Measurement ON/OFF
Data range	0 to 1 0 : OFF 1 : ON

3.Details of command – 3.2.Module setting (M commands)

P4	Measurement range			
Data range	0 to 7	0 : 500 V	1 : 200 V	2 : 100 V
		3 : 50 V	4 : 20 V	5 : 10 V
		6 : 5 V	7 : 2 V	

P5	Input coupling		
Data range	0 to 1	0 : GND	1 : DC

P6	Low pass filter					
Data range	0 to 4	0 : OFF	1 : 3 Hz	2 : 30 Hz	3 : 300 Hz	4 : 3 kHz

3.3. Reading information (I commands)

3.3.1. I00: Reading information of main unit, type, serial No.

Command	I00
Command message	I00
Response message	ACK I00,<A1>
Remarks	The recorder information is outputted by ACK response. Refer to " Setup Details " - " Version Management " in the instruction manual of the RA3100.

ACK response

A1	Recorder information
Content of response	Format : Product name (SP) Model (SP) Recorder version (SP) Serial number (Example of ACK response) omniace RA3100 VerAA.BB.CC S/N36XXXXXX
Remarks	AA = Major Version BB = Minor Version CC = Revision XXXXXX = Serial number

3.3.2. I04: Reading board information of input module

Command	I04
Command message	I04
Response message	ACK I04,<A1>,<A2>,...,<A9>
Remarks	The board information of input module installed in slot is read. Refer to " Setup Details " - " Version Management " in the instruction manual of the RA3100.

ACK response

A1 to A9	Module information installed in slot 1 to slot 9
Content of response	A1 : Information of slot 1, A2 : Information of slot 2, ... A9 : Information of slot 9
Data range	0, 1 0: Not installed [bit 31 to 24]: Major Version [bit 23 to 16]: Minor Version [bit 15 to 8]: Revision [bit 7 to 0]: ID
Remarks	Version and ID of module installed in slot are outputted. 32 bit data in decimal number is responded. The module can identify using ID. ID 1 = RA30-101 2 = RA30-102 3 = RA30-103 4 = RA30-104 5 = RA30-105 6 = RA30-106 7 = RA30-107 8 = RA30-108 9 = RA30-109 12 = RA30-112

3.3.4. I07: Recording setting error readout

Command	I07
Command message	I07
Response message	ACK I07,<A1>
Remarks	Reads whether there is an error in the recording settings.

ACK response

A1	Status
Content of response	0 - bit 0 : System error bit 1 : Insufficient SSD capacity bit 2 : Recording time bit 3 : Recording sample count bit 4 : Interval recording count bit 5 : Interval time bit 6 : Memory recording active bit 7 : Memory recording sampling speed bit 8 : Memory block count bit 9 : Memory block sample count bit 10 : SSD recording active bit 11 : SSD recording sampling speed bit 12 : Printer recording active bit 13 : Printer recording sampling speed bit 14 : Module channel measurement OFF bit 15 : Recording start time bit 16 : Remote module not inserted bit 17 : Recording folder count upper limit bit 18 : Recording mode
Remarks	If "0", there is no error. If other than "0", there is an error. A decimal number is output with the bits corresponding to the content of the error on. (Example ACK response) ACK I07,131088(CR)(LF) 131088 (decimal) = 010 0000 0000 0001 0000 (binary) bit 4 : Interval recording count bit 17 : Recording folder count upper limit

3.3.5. I09: Physical quantity calculation coefficient readout

Command	I09
Command message	I09 <P1>,<P2>
Response message	ACK I09,<A1>,<A2>,<A3>
Remarks	<p>Reads the information required for conversion from the AC count value to the physical quantity.</p> <p>(example) When AD count value = 32000, <A1> = 3.125E-03, <A2> = 0E+00, and <A3> =<STX>V<ETX></p> <p>Physical value = $32000 \times 3.125E-03 + 0E+00 = 100$ [V]</p>

Parameter

P1	Slot
Data range	1 to 9
Remarks	The slot number where the target module is installed.

P2	Channel
Data range	1 to 4
Remarks	The target channel number.

ACK response

A1	Gain
Content of response	Numeric value (range: double type)
Remarks	The value to multiply with the AD count value.

A2	Offset
Content of response	Numeric value (range: double type)
Remarks	The value to add to the AD count value.

A3	Unit
Content of response	String
Remarks	<p>Maximum 10 characters. Enclosed between <STX> [0x02] and <ETX> [0x03].</p> <p>(Example) <STX>V<ETX></p>

3.4. Execution process (E commands)

3.4.1. E01: Execute canceling the input offset (zero-cancel)

Command	E01
Command message	E01 <P1>,<P2>
Response message	ACK E01
Remarks	The E01 performs zero-cancel of target channel. Refer to " Using Optional Modules " – " 2ch Voltage Module (RA30-101) " in the instruction manual of the RA3100. Other module that equips zero-cancel function is same, too.

Parameters

P1	Slot number
Data range	1 to 9, F
Remarks	Specify slot number that the target module is installed. When F is selected, all modules are target.

P2	Channel
Data range	1 to 4, F
Remarks	Specify channel of module selected at P1. When F is selected, all channels are target.

3.4.2. E07: Execute start and end recording

Command	E07
Command message	E07 <P1>
Response message	ACK E07
Remarks	The E07 performs starting and ending of recording. When starting command is received during recording, error occurs. Refer to " Measuring Input Signals " – " Starting and Ending Recording " in the instruction manual of the RA3100.

Parameters

P1	Starting and ending of recording
Data range	0 to 1 0 : End 1 : Start
Remarks	For "0: End", the post-process (save process and print end process) for stopping recording has not completed when the ACK message is returned. An NAK message is returned if the next command is received before the post-process is complete. For information on the method for waiting for the post-process to complete, refer to " 5.1.2 Start or stop recording ".

3.4.9. E23: Bridge check

Command	E23
Command message	E23 <P1>,<P2>
Response message	ACK E23
Remarks	Executes a bridge check for the specified channel of the RA30-104 (2ch AC strain module). Refer to " Using Optional Modules " – " 2ch AC Strain Module (RA30-104) " in the instruction manual of the RA3100.

Parameter

P1	Slot
Data range	1 to 9, F
Remarks	Specifies the slot where the RA30-104 (2ch AC strain module) is installed. When "F" is specified, all RA30-104 (2ch AC strain modules) are targeted.

P2	Channel
Data range	1 to 2, F
Remarks	Specifies the channel of the module specified in P1. When "F" is specified, all channels are targeted.

3.4.10. E24: TEDS readout

Command	E24
Command message	E24 <P1>,<P2>
Response message	ACK E24
Remarks	Executes TEDS reading for the specified channel of the RA30-109 (2ch acceleration module). Refer to " Using Optional Modules " – " 2ch Acceleration Module (RA30-109) " in the instruction manual of the RA3100.

Parameter

P1	Slot
Data range	1 to 9, F
Remarks	Specifies the slot where the RA30-109 (2ch acceleration module) is installed. When "F" is specified, all RA30-109 (2ch acceleration modules) are targeted.

P2	Channel
Data range	1 to 2, F
Remarks	Specifies the channel of the module specified in P1. When "F" is specified, all channels are targeted.

3.4.11. E25: Count reset

Command	E25
Command message	E25 <P1>,<P2>
Response message	ACK E25
Remarks	Resets the pulse integration value of the RA30-108 (2ch frequency module). Refer to "Using Optional Modules" – "2ch Frequency Module (RA30-108)" in the instruction manual of the RA3100.

Parameter

P1	Slot
Data range	1 to 9, F
Remarks	Specifies the slot where the RA30-108 (2ch frequency module) is installed. When "F" is specified, all RA30-108 (2ch frequency modules) are targeted.

P2	Channel
Data range	1 to 2, F
Remarks	The measurement mode of the module specified in P1 specifies the channel of pulse integration. When "F" is specified, all channels are targeted.

3.4.12. E27: Recorded data deletion

Command	E27
Command message	E27 <P1>
Response message	ACK E27
Remarks	Deletes the recorded data saved on the internal SSD.

Parameter

P1	Target for deletion
Data range	F: Delete all Name of recorded data folder (18 digit number): Delete specified folder.
Remarks	The deletion process starts after the ACK response is received. The status of the deletion process can be checked using the "3.3.3. I05: Reading the status of main unit " command. "0" (preparing) is returned if the deletion process is ongoing or "1" (measuring) is returned if the deletion process is complete.

4. Specifications of hardware

4.1. LAN port

Items	Specifications
Adaptable standards	IEEE802.3 complied with standards (100BASE-T, 100BASE-TX, 10BASE-T)
Connector	RJ-45
Port	1

4.2. COM port

Items	Specifications
Adaptable standards	EIA-574 complied with standards
Communication speed	300 to 460800 bps
Data length	8 bit fixed
Stop bit	1 bit, 2 bit selection
Parity bit	None, odd, even, mark, space selection
Flow control	None, Xon/Xoff, Hardware (CTS/RTS) selection
Connector	D-sub 9 pin
Port	1

Pin assignment :

Pin No.	Name	IN/OUT	Functions
1	N.C.	-	
2	RxDATA	IN	Receive data
3	TxDATA	OUT	Transmit data
4	N.C.	-	
5	GND		GND
6	N.C.	-	
7	RTS	OUT	Request to send
8	CTS	IN	Clear to send
9	N.C.	-	

5. Appendix

5.1. Command operation procedure

5.1.1. Recording settings

Example command for configuring and checking recording settings

Even if an ACK response is successfully received for the following commands regarding recording settings, recording may not be able to be started in some cases, due to reasons such as insufficient SSD capacity.

- S01 Common recording configuration command
- S02 Memory recording configuration command
- S03 SSD recording configuration command
- S04 Printer recording configuration command

Use I07 (recording setting error readout command) to check whether a recording setting error occurred after issuing a command regarding recording configuration.

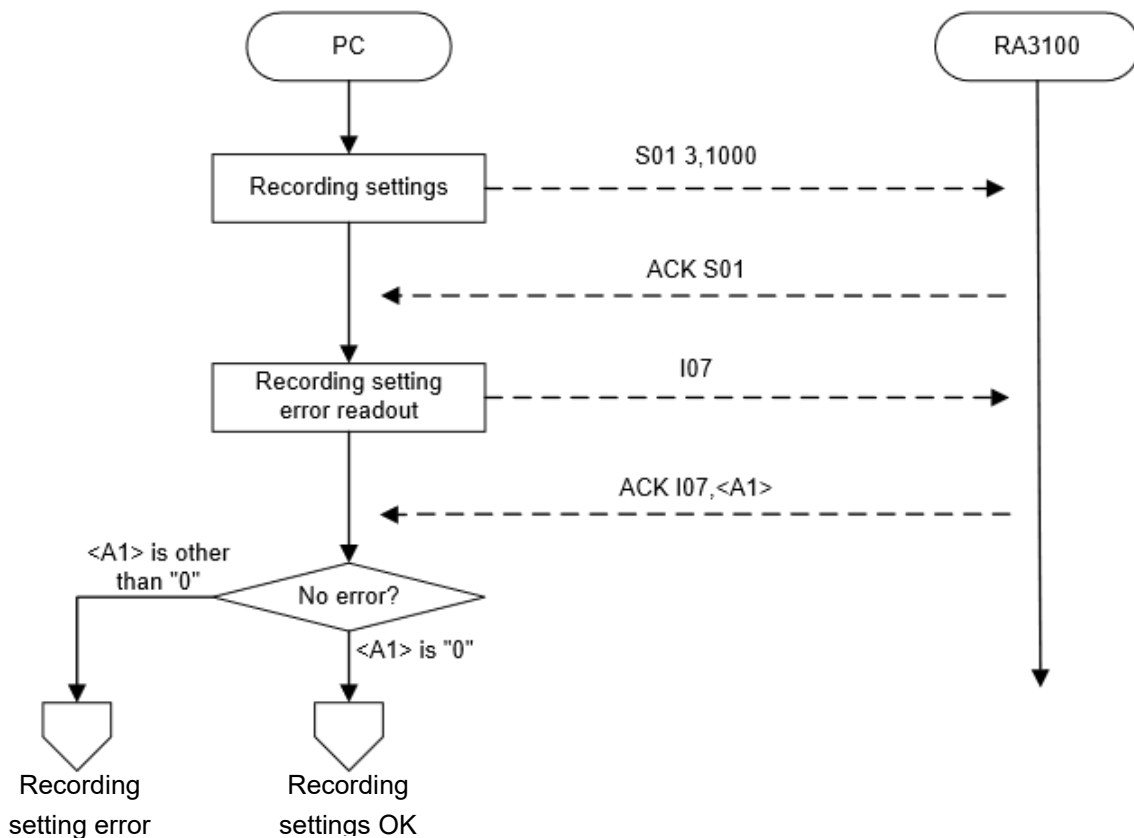

*Dotted lines indicate communication

5.1.2. Start or stop recording

Example command to start and stop recording

Issue E07 1 (recording start command) to start recording.

To stop recording, issue E07 0 (recording stop command).

When the ACK message for stopping recording is returned, the response is "stopping recording" because the post-process for stopping recording (such as the save process and print end process) has not completed. A NAK message is returned if a command other than an I command is received while stopping recording. Issue the next command after the post-process for stopping recording is complete and the response for I05 (RA3100 status information readout command) is "measuring".

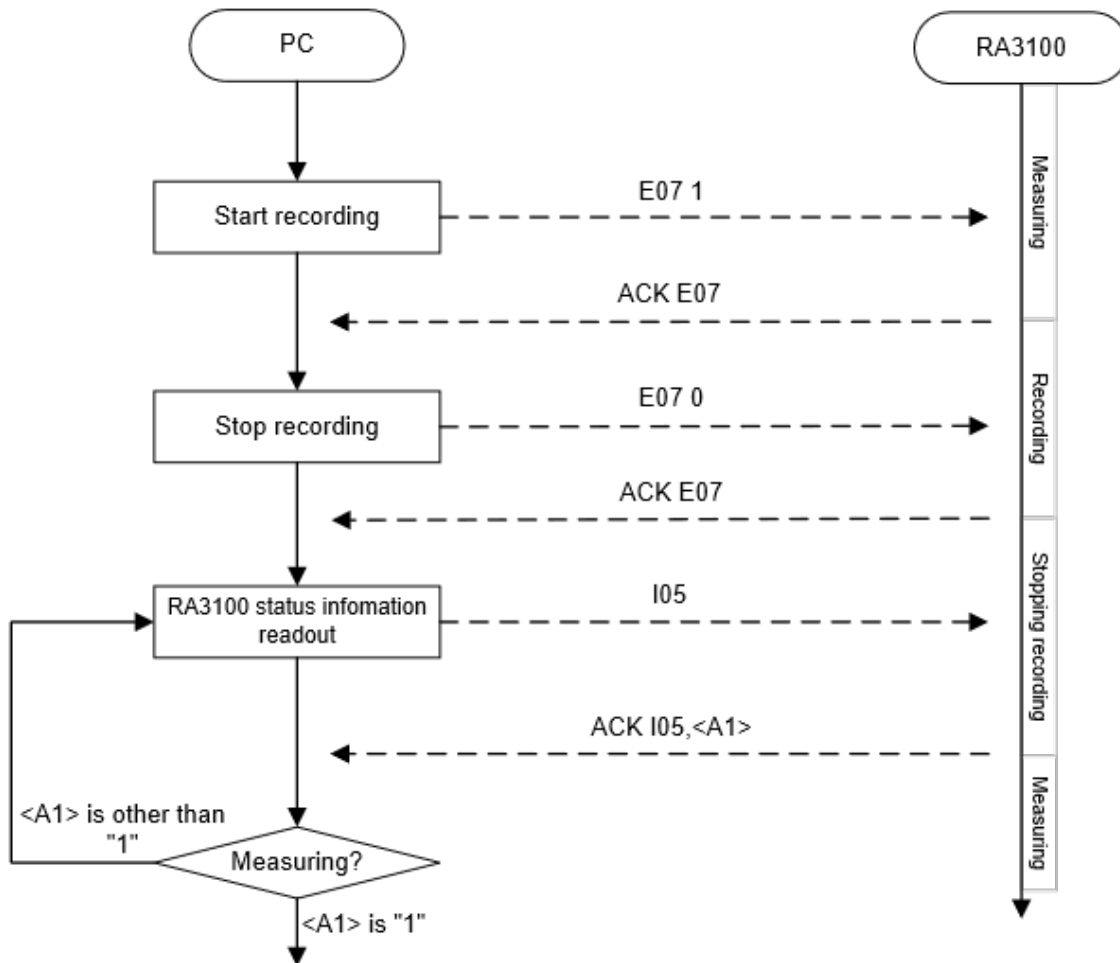

*Dotted lines indicate communication

5.2. Cautions when using the scale conversion function and wave inversion function

For the following command parameters, the scale conversion (physical quantity conversion) function and wave inversion function are automatically reflected.

Therefore, even if the function is enabled, it is necessary to specify values and settings for the waveform with the function disabled.

Command	Parameters		
S21: Start-trigger configuration (analog input signal)	P4: Trigger threshold upper limit value	P5: Trigger threshold lower limit value	P6: Trigger type
S24: Memory-trigger configuration (analog input signal)	P5: Trigger threshold upper limit value	P6: Trigger threshold lower limit value	P7: Trigger type
M04: RA30-104 settings	P7: CAL	P8: CAL value	P9: R-FINE

Example of issuing command with function enabled

An example of execution by issuing a command with scale conversion and wave inversion performed.

Waveform with function disabled

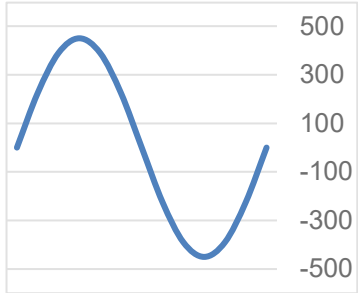

Scale conversion: Compensation
(gain 2, offset 0)
Wave inversion: Enabled

Waveform with function enabled

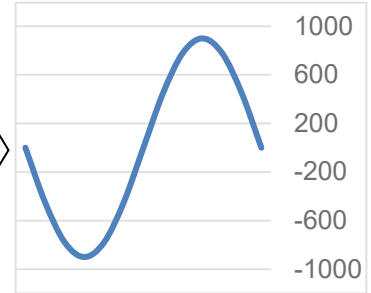

S21: Start-trigger configuration

To set the upper limit value to 200 V and lower limit value to -600 V for the waveform with the function enabled, it is necessary to consider the waveform with the function disabled and issue the commands in P4 and P5.

P4: Specify 300 V (19200) as the trigger threshold upper limit value.

P5: Specify -100 V (-6400) as the trigger threshold lower limit value.

The settings displayed as a result are upper limit 200 V and lower limit value -600 V, with scale conversion and wave inversion reflected.

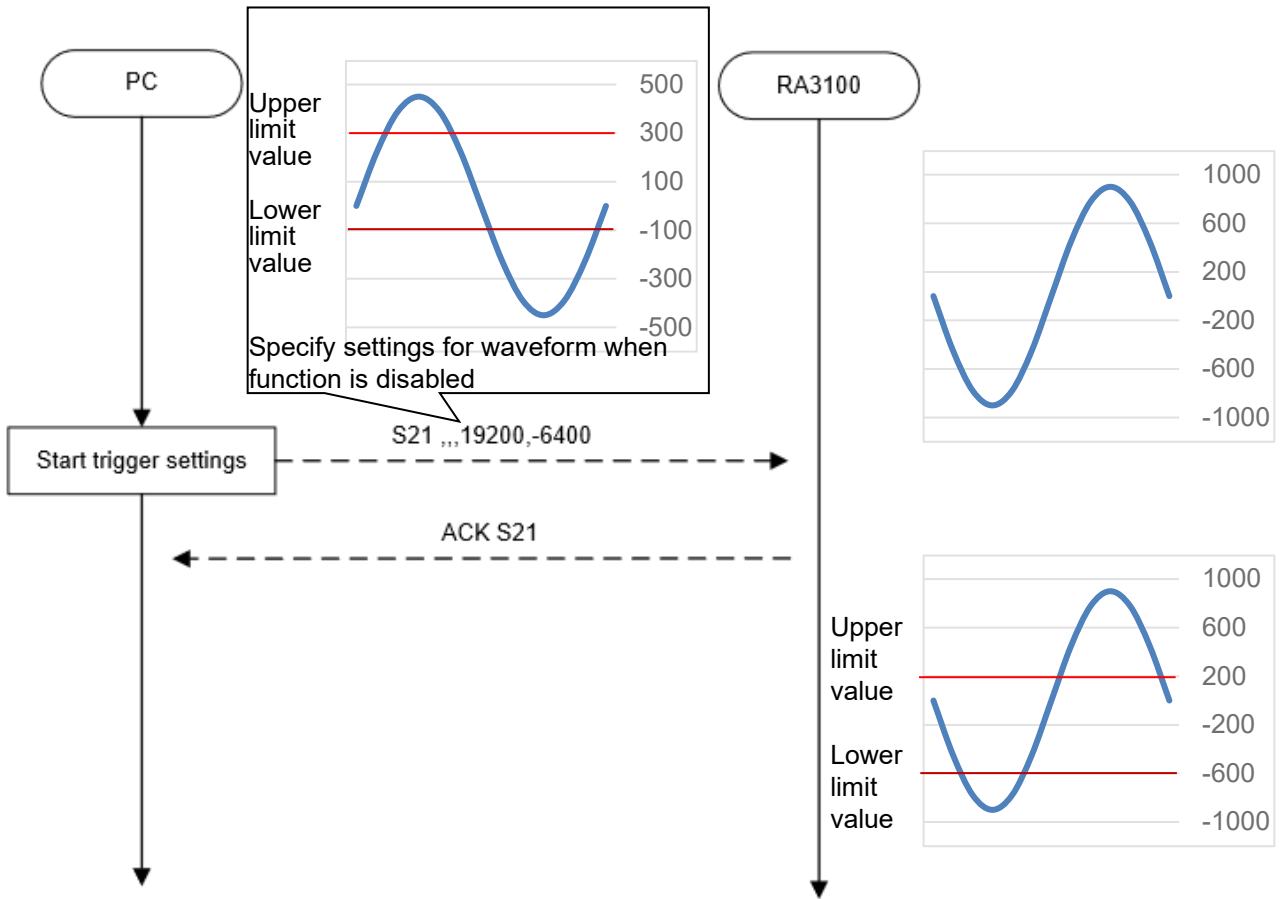

Omniace
RA3100

Communication command

1WMPD4004790B

3rd Edition



A&D Company, Limited

3-23-14 Higashi-Ikebukuro, Toshima-ku, Tokyo 170-0013, JAPAN
Telephone: [81] (3) 5391-6132 Fax: [81] (3) 5391-1566

A&D ENGINEERING, INC.

47747 Warm Springs Blvd, Fremont, California 94539, U.S.A.
Tel: [1] (800) 726-3364 Weighing Support:[1] (888) 726-5931 Inspection Support:[1] (855) 332-8815

A&D INSTRUMENTS LIMITED

Unit 24/26 Blacklands Way, Abingdon Business Park, Abingdon, Oxfordshire OX14 1DY United Kingdom
Telephone: [44] (1235) 550420 Fax: [44] (1235) 550485

A&D AUSTRALASIA PTY LTD

32 Dew Street, Thebarton, South Australia 5031, AUSTRALIA
Telephone: [61] (8) 8301-8100 Fax: [61] (8) 8352-7409

A&D KOREA Limited

한국에이.엔.디(주)
서울특별시 영등포구 국제금융로6길33 (여의도동) 맨하탄빌딩 817 우편 번호 07331
(817, Manhattan Bldg., 33. Gukjegeumyung-ro 6-gil, Yeongdeungpo-gu, Seoul, 07331 Korea)
전화: [82] (2) 780-4101 팩스: [82] (2) 782-4264

ООО A&D RUS

ООО "ЭЙ энд ДИ РУС"

Почтовый адрес:121357, Российская Федерация, г.Москва, ул. Верейская, дом 17
Юридический адрес: 117545, Российская Федерация, г. Москва, ул. Дорожная, д.3, корп.6, комн. 86
(121357, Russian Federation, Moscow, Vereyskaya Street 17)
тел.: [7] (495) 937-33-44 факс: [7] (495) 937-55-66

A&D Instruments India Private Limited

ऐ&डी इन्स्ट्रुमेंट्स इण्डिया प्रा० लिमिटेड

D-48, उद्योग विहार , फेस -5, गुडगांव - 122016, हरियाणा , भारत
(D-48, Udyog Vihar, Phase-V, Gurgaon - 122016, Haryana, India)
फोन : [91] (124) 4715555 फैक्स : [91] (124) 4715599

A&D SCIENTECH TAIWAN LIMITED.

艾安得股份有限公司

台湾台北市中正區青島東路 5 號 4 樓
(4F No.5 Ching Tao East Road, Taipei Taiwan R.O.C.)
Tel : [886](02) 2322-4722 Fax : [886](02) 2392-1794

A&D INSTRUMENTS (THAILAND) LIMITED

บริษัท เอ แอนด์ ดี อินสตรูमेंท์ (ไทยแลนด์) จำกัด

168/16 หมู่ที่ 1 ตำบลรังสิต อำเภอธัญบุรี จังหวัดปทุมธานี 12110 ประเทศไทย
(168/16 Moo 1, Rangsit, Thanyaburi, Pathumthani 12110 Thailand)
Tel : [66] 20038911