

BA SERIES

Analytical Balances

INSTRUCTION MANUAL

BA-6E

BA-6DE

BA-225

BA-225D

BA-125D

© 2021 A&D Company Ltd. All rights reserved.

No part of this publication may be reproduced, transmitted, transcribed, or translated into any language in any form by any means without the written permission of A&D Company Ltd.

The contents of this manual and the specifications of the instrument covered by this manual are subject to change for improvement without notice.

Windows, Word and Excel are trademarks of the Microsoft Corporation., registered in the U.S. and other countries and regions.

Product names and company names mentioned in this manual are trademarks or registered trademarks of their respective companies in Japan or other countries and regions.

Contents

1.	Introduction.....	6
1.1.	Features.....	6
2.	Part Names, Installation and Precautions.....	7
2.1.	Unpacking.....	8
2.2.	Assembly and installation.....	9
2.3.	Installation considerations, preparation and precautions.....	12
2.3.1.	How to adjust the level of the balance.....	13
2.4.	Precautions during use for more accurate weighing.....	14
2.5.	Precautions after use.....	15
2.6.	Caution on the power supply.....	15
2.7.	Connection terminals of the display unit.....	15
3.	Display and Key Panel (Basic Operation).....	16
3.1.	Display.....	16
3.2.	IR sensors and auto doors.....	18
3.2.1.	IR sensors.....	18
3.2.2.	Auto doors.....	19
4.	Weighing.....	20
4.1.	Unit of measure.....	20
4.1.1.	Storing Units.....	24
4.1.2.	Unit setting example.....	25
4.2.	Basic operation.....	26
4.2.1.	Zero-point, tare, and weighing range.....	26
4.3.	Smart range function.....	28
4.4.	Counting mode (PCS).....	29
4.5.	Percent mode (Percent weighing mode).....	31
5.	Response Adjustment/Weighing Speed Setting.....	32
5.1.	Response adjustment.....	32
6.	Sensitivity Adjustment/Calibration Test.....	33
6.1.	Automatic sensitivity adjustment.....	34
6.1.1.	Inputting the set time.....	35
6.1.2.	Clearing the set time.....	36
6.1.3.	Setting the interval time.....	36
6.2.	Sensitivity adjustment using the internal weight.....	37
6.3.	Calibration test using the internal weight.....	38
6.4.	Sensitivity adjustment using an external weight.....	39
6.5.	Calibration test using an external weight.....	40
6.6.	Setting the value of the weight.....	41
6.7.	Correcting the internal weight value.....	41
6.7.1.	Correcting the internal weight value.....	42
7.	Function Selection Switch and Initialization.....	43
7.1.	Function selection switch.....	43
7.2.	Initialization.....	44
8.	Function Table.....	45
8.1.	Setting the function table.....	45
8.2.	Details of the function table.....	47
8.3.	Description of the class “Environment/Display”.....	53

8.4.	Clock and calendar function	55
8.4.1.	Batch output of the function table information.....	56
9.	GLP Report and ID Number.....	58
9.1.	Main objectives	58
9.2.	Setting the ID number.....	59
9.3.	GLP output.....	60
10.	Data Memory.....	66
10.1.	Data memory for weighing data.....	66
10.2.	Data memory for sensitivity adjustment and calibration test.....	70
10.3.	Data memory for “unit weight” in the counting mode	72
10.3.1.	Registering unit weight data	72
10.3.2.	Reading the unit weight data.....	73
11.	Gross/Net/Tare Function.....	74
11.1.	Preparations for gross/net/tare function	74
11.2.	Using the gross/net/tare function (example)	76
12.	Minimum Weight Alert Function.....	77
12.1.	Enabling the minimum weight comparison.....	78
12.2.	Inputting and outputting the minimum weight.....	78
12.2.1.	Setting procedure using the function table.....	78
12.2.2.	Setting procedure in weighing mode.....	80
12.2.3.	Outputting the setting values in batch.....	81
12.3.	Outputting data less than the minimum weight	82
13.	Underhook.....	83
14.	Password Function.....	84
14.1.	Enabling the password function	85
14.2.	Entering a password at the start of weighing	86
14.3.	Logging out.....	86
14.4.	Registering (changing) the password.....	87
14.5.	Changing the password.....	88
14.6.	Deleting the password (USER 01 to USER 10).....	89
14.7.	If the password is lost or forgotten	89
14.8.	Function selection switch by user (ADMIN, USER 01 to USER 10).....	90
14.9.	Password function operation	91
15.	Repeatability Check Function	92
16.	Interface Specification (Standard)	93
16.1.	RS-232C	93
16.2.	USB.....	94
16.3.	External input terminal.....	94
17.	Connection with Peripheral Devices	96
17.1.	Cables required to connect to peripheral devices.....	96
17.2.	Data output method	96
17.3.	Examples: Connecting multiple peripheral devices.....	97
17.3.1.	Printer and personal computer connection	97
18.	Printing Weighing Value Data with a Printer.....	98
18.1.	For an AD-8127 multi-functional compact printer.....	98
18.1.1.	Printing only weighing value data.....	98
18.1.2.	Printing weighing value data with the ID number and timestamp using the clock/calendar function of the balance	99

18.1.3.	Printing information other than weighing value data	99
19.	Connecting to a Personal Computer	100
19.1.	Quick USB mode	100
19.2.	Virtual COM mode	101
19.3.	RS-232C	101
19.4.	Data communication software WinCT (USB Virtual COM mode or RS-232C).....	102
20.	Data Output	103
20.1.	Data output mode	103
20.2.	Weighing data format.....	105
20.3.	Output examples of weighing data format.....	110
20.4.	Other data formats	112
21.	Commands	114
21.1.	Control commands.....	114
21.2.	<AK> code and error codes.....	116
21.3.	Command usage examples.....	117
22.	Error Displays (Error Codes).....	120
23.	UFC Function	123
23.1.	UFC program commands	123
23.1.1.	Examples of UFC program command creation.....	124
24.	Key Lock Function.....	125
24.1.	Locking all key switches	125
24.2.	Locking a specified key switch	125
25.	Maintenance.....	126
25.1.	Treatment of the balance.....	126
26.	Troubleshooting	127
26.1.	Checking the balance performance and environment	127
26.2.	Other display.....	128
26.3.	Asking for repair.....	128
27.	Checking the Software Version of the Balance	129
28.	Ionizer (AX-ION-25)	130
28.1.	Usage.....	130
28.2.	Maintaining the ionizer.....	131
29.	Specifications	132
29.1.	Common specifications	132
29.1.1.	Function.....	132
29.1.2.	Size/Weight	132
29.2.	Individual Specifications	133
29.3.	External dimensions	135
29.4.	Peripherals.....	137

1. Introduction

Thank you for purchasing A&D's electronic balance.

Please read this instruction manual carefully to understand and make full use of the BA series analytical balance.

Caution. Operations may differ depending on the software version of your balance.

For confirmation of the software version of the balance, refer to "[27. Checking the Software Version of the Balance](#)".

1.1. Features

- Equipped with the breeze break auto doors that can be opened and closed without touching them.
- The removable glass breeze break makes it easy to clean the inside of the weighing chamber.
- Equipped with a data memory function to store weighing values, sensitivity adjustment records, calibration test results, and multiple unit weights (mass per sample in counting mode). (For weighing values, up to 200 values can be stored.)
- The BA series can automatically perform sensitivity adjustment with the internal weight. (Automatic sensitivity adjustment)
(Temperature change, set time, fixed time interval [interval time])
- When performing sensitivity adjustment, calibration test, etc., the output corresponding to GLP/GMP etc. can be output. Using a printer (sold separately), it is possible to record the sensitivity adjustment/calibration test results.
GLP: Good Laboratory Practice. Standards for implementing safety tests for drugs and medicines.
GMP: Good Manufacturing Practice. Rules for manufacturing and quality control.
- The clock function built into the balance allows you to output the weighing value with the date and time. (The clock settings can be restricted so that only the Administrator can change them. [Password function])
- The BA series comes standard with the underhook for weighing magnetic materials.
- Multiple units of measure are available, including the most common units used around the world.
- BA-6DE/BA-225D/BA-125D has the smart range function as standard. This function allows for weighing with the precision range after subtracting the tare within the weighing capacity.
The readability of precision range for BA-6DE is 1 µg.
The readability of precision range for BA-225D/BA-125D is 10 µg.
- With the password function, the use of the balance and the operation of changing the function table can be restricted.
- With the key lock function, the key operation can be disabled and the balance can be operated only by a command from an external device.
- RS-232C and USB interfaces for outputting the weighing value and data of the balance are equipped as standard. Windows Communication Tools Software (WinCT) makes it easy to communicate with a Windows personal computer. The latest version of WinCT is available for download on A&D website.
- The BA-6E and BA-6DE are equipped with a DC type ionizer (static eliminator) that does not generate wind, and eliminates static electricity from charged objects before weighing in order to reduce errors due to static electricity. The discharge electrode unit of the ionizer can be removed and can be cleaned and replaced by itself.

2. Part Names, Installation and Precautions

Caution

- This product is a precision instrument, and it should be carefully unpacked.
It is advisable to store the packing materials so that they can be used when transporting the balance for repair.
- The contents of the package vary depending on the product. Refer to the illustration of the packing contents and make sure that everything is included.
- Do not connect the AC adapter to the balance until the balance is assembled and installed.
- Do not connect the included AC adapter to other devices.
- Use the dedicated AC adapter specified for the balance.
- If you use the wrong AC adapter, the balance and other equipment may not work properly.
- Make sure that the AC adapter is unplugged before you connect the breeze break unit and the ionizer.
- The BA series analytical balance is composed of the weighing unit and display unit. It is not possible to replace just one of the units.

2.1. Unpacking

Packing contents common to BA series

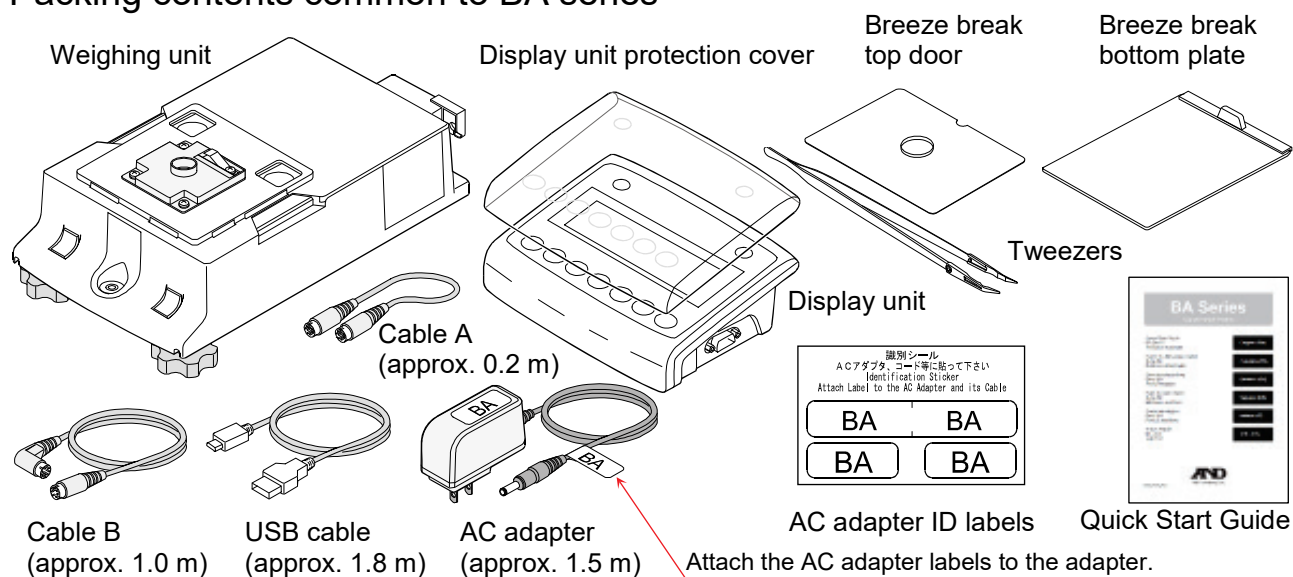

Packing contents for BA-6E/BA-6DE

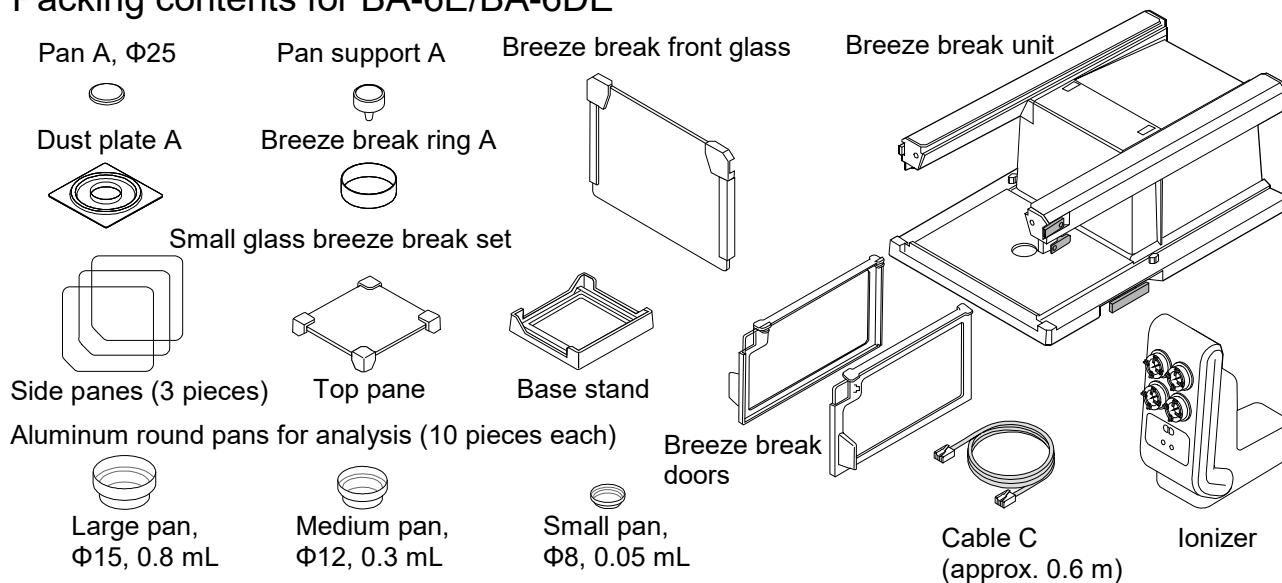

Packing contents for BA-225/BA-225D/BA-125D

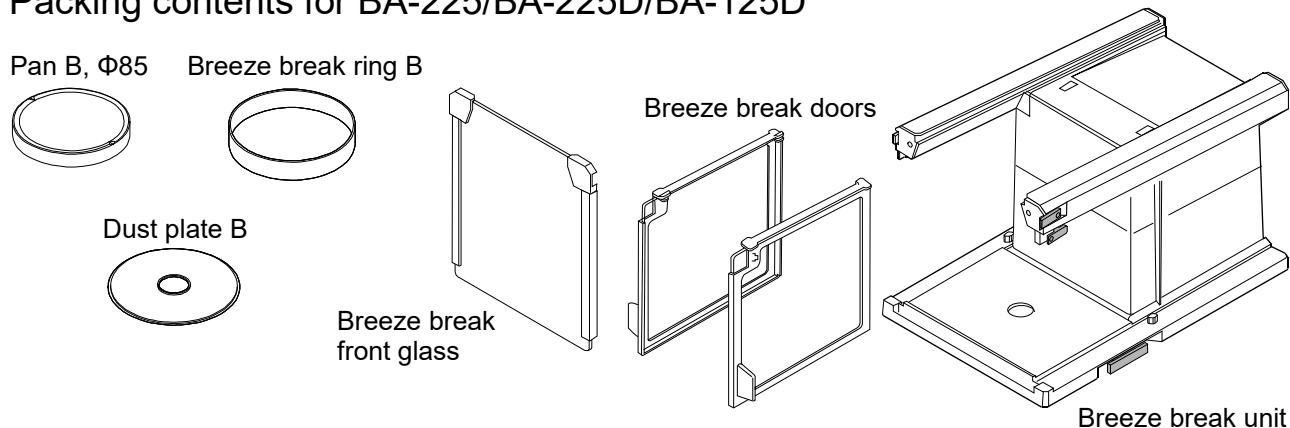

2.2. Assembly and installation

The BA-6E is used here for the example of assembly. Other models can be assembled in the same way.

Step 1. Pull out the breeze break locking handles.

Step 2. Place the breeze break unit on the weighing unit.

Step 3. Push in the breeze break locking handles to secure the units to each other.

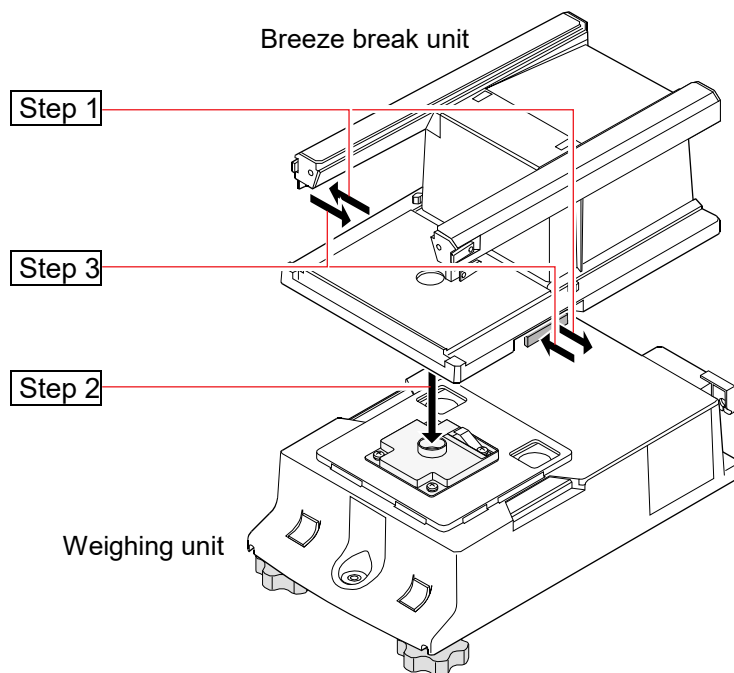

Step 4. Assemble the weighing pan.

For BA-6E/BA-6DE, assemble the five parts of the weighing pan in the correct position by referring to the cross-sectional view.

For BA-225/BA-225D/BA-125D, assemble the four parts of the weighing pan in the correct position by referring to the cross-sectional view.

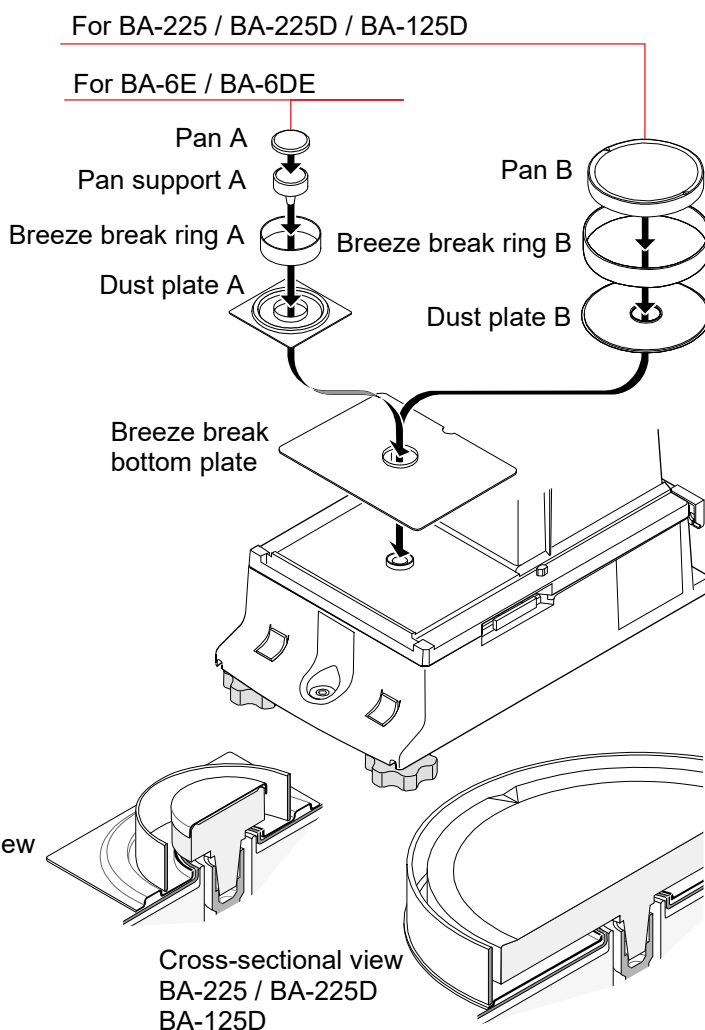

Step 5. Assemble the glass breeze break.

Assemble the BA-6E/BA-6DE glass breeze break in the weighing chamber.
Align the side panes with the notch of the base stand.

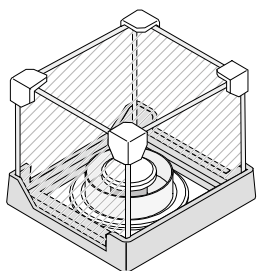

Example of the small breeze break with the right side open.

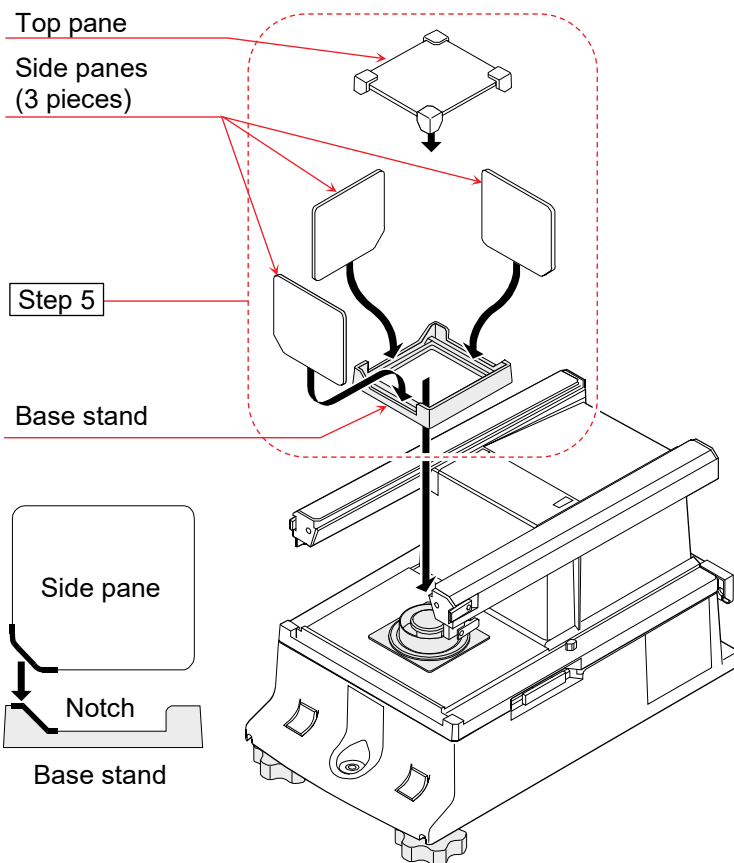

Step 6. Insert the breeze break top door from the handle side.

Step 7. Assemble the breeze break doors on the left and right sides.

- 7a Insert the breeze break doors on the left and right sides.
- 7b Secure the breeze break doors with the latches.

Step 8. Assemble the breeze break front glass.

- 8a Insert the breeze break front glass.
- 8b Secure the breeze break front glass with the latches.

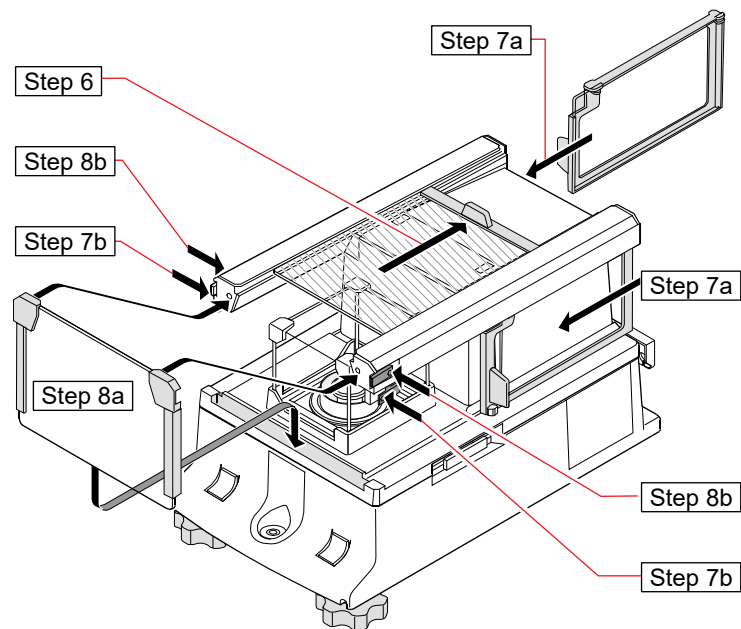

Step 9. Using the included cable A and cable B, connect the "weighing unit" and "breeze break unit" (with the cable A) and the "display unit" and "weighing unit" (with the cable B) respectively, paying attention to the direction of the arrow on each cable (on the connector).

Caution. Make sure to unplug the AC adapter before connecting.

Step 10. If the display unit is placed in front of the weighing unit, cable B can be stowed in the left or right groove of the weighing unit. Loosen the leveling foot when stowing the cable in the groove.

Caution. When stowing the cable, do not tilt the weighing unit.

Step 11. Connect the breeze break unit and ionizer with the included cable C.

Caution. The ionizer operates when the AC adapter is connected to the balance.

Step 12. Connect the included AC adapter to the balance.

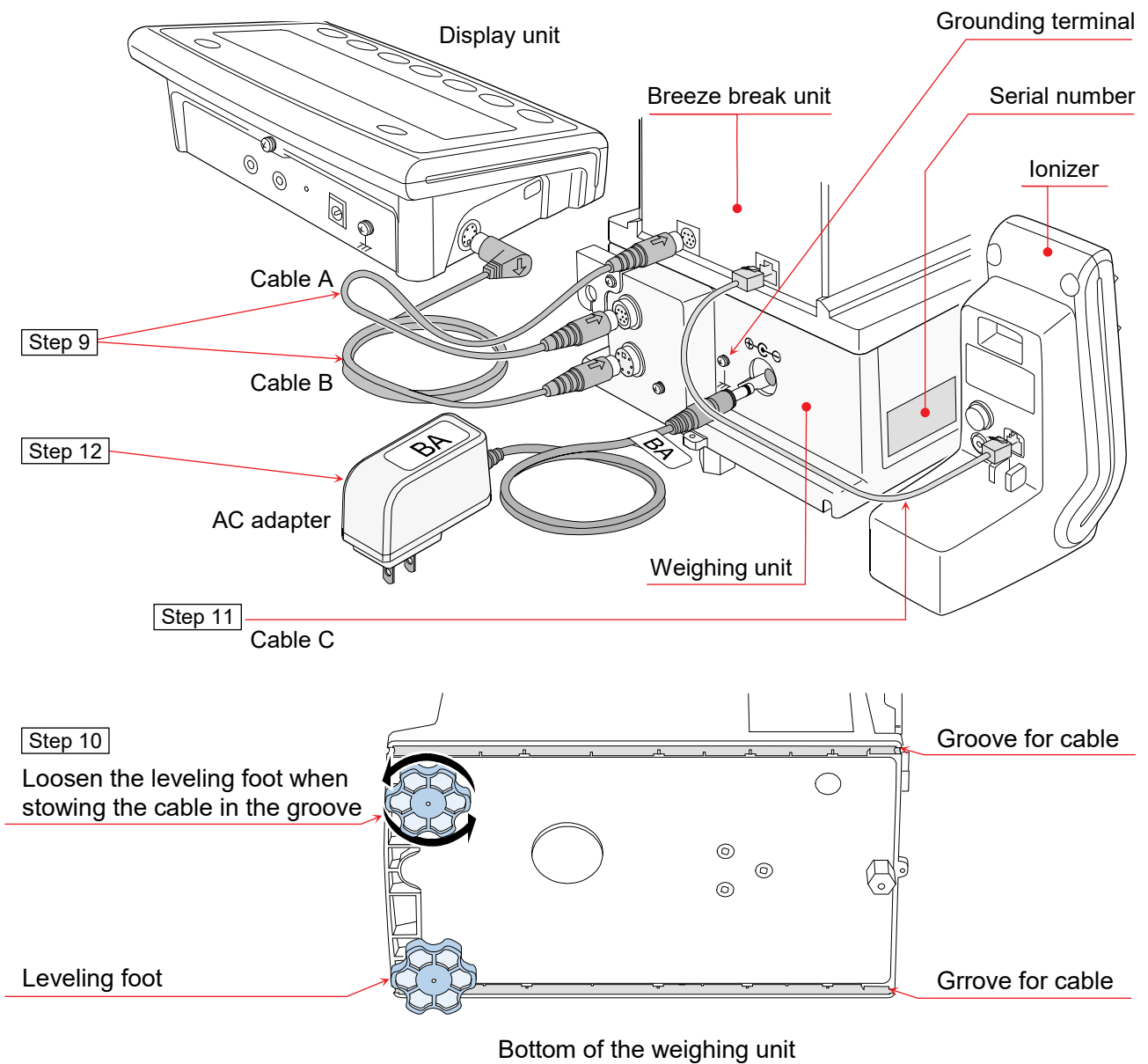

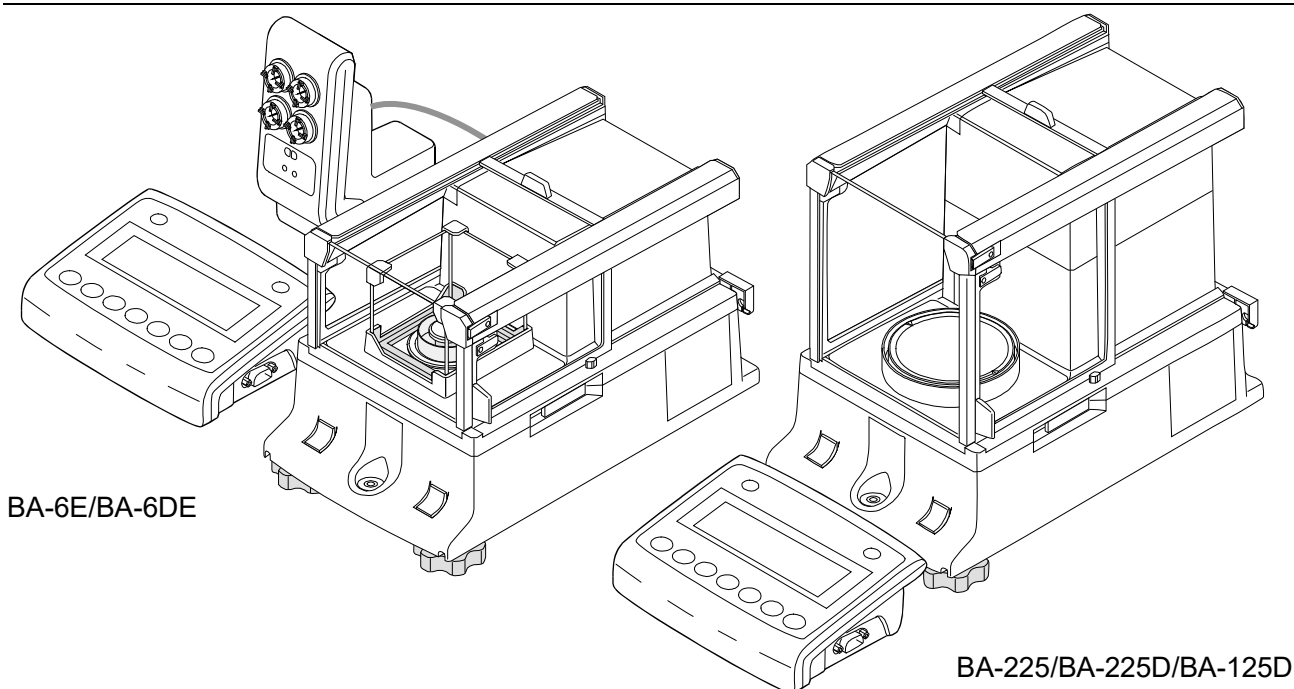

BA-6E/BA-6DE

BA-225/BA-225D/BA-125D

2.3. Installation considerations, preparation and precautions

- Prepare the following installation conditions in order to bring out the full performance of the balance. Note that the installation environment needs to be taken into consideration with the highly sensitive BA-6E/BA-6DE.
- Install the balance in an environment where the temperature and humidity are not excessive. The best operating temperature is about $20^{\circ}\text{C} \pm 2^{\circ}\text{C}$ at about 45% to 60% RH relative humidity.
- Install the balance where it is free of dust.
- The weighing table should be solid. (An anti-vibration table or stone table is ideal.)
- Place the balance on a horizontal table, and make sure that it is not tilted.
We recommend using an anti-vibration table (AD-1671) for the BA-6E/BA-6DE.
It is advisable to install the display unit in a location other than on the antivibration table so that errors due to tilt that occurs when operating the switches of the balance on the anti-vibration table can be avoided.
- Install the balance in a stable location, avoiding vibration and shock. Corners of rooms on the first floor are best, as they are less prone to vibration.
- Install the balance where it is not affected by heaters or air conditioners. Avoid breezes and drafts in the room.
You can reduce the influence of breezes and drafts by using an AD-1672/AD-1672A (large size) or AD-1676 (medium size) tabletop breeze break.
- Install the balance where it is not exposed to direct sunlight.
- Install the balance away from equipment which produces magnetic fields.
- Level the balance with the leveling feet and bubble spirit level. Refer to [“2.3.1. How to adjust the level of the balance”](#).
- Be sure to warm up the balance before use for at least an hour, or at least four hours for BA-6E/BA-6DE, with the AC adapter connected to the power supply.
- Adjust the sensitivity of the balance before using it for the first time or after having moved it to another location so that accurate weighing can be performed. For details, refer to [“6. Sensitivity Adjustment/Calibration Test”](#).

CAUTION Do not install the balance where flammable or corrosive gas is present.

2.3.1. How to adjust the level of the balance

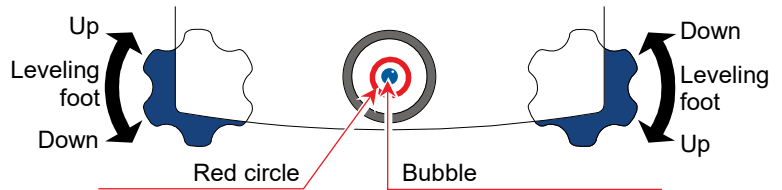
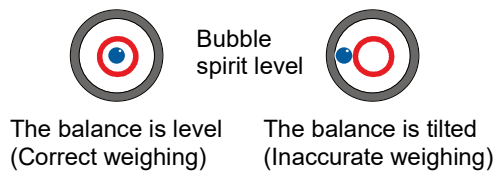

- Level the balance by adjusting the leveling feet so that the bubble of the bubble spirit level is centered in the red circle.

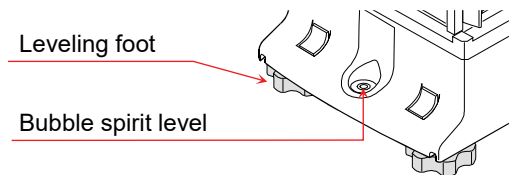

When the bubble is off to the left.

Turn the leveling foot on the front right in the clockwise direction.

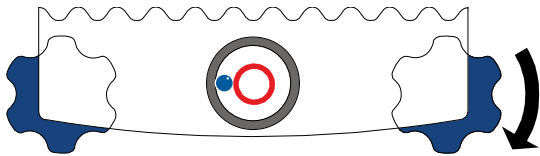

When the bubble is off to the right.

Turn the leveling foot on the front left in the clockwise direction.

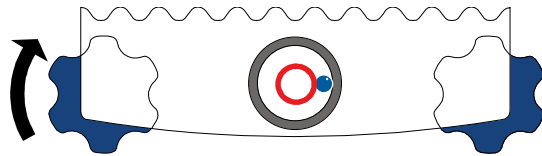

When the bubble is off to the backward position.

Turn both leveling feet on the front in the clockwise direction at the same time.

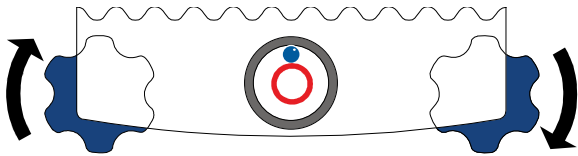

When the bubble is off to the forward position.

Turn both leveling feet on the front in the counter clockwise direction at the same time.

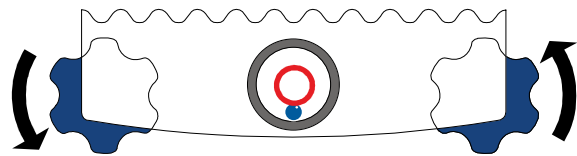

2.4. Precautions during use for more accurate weighing

For precise and accurate weighing, please take notice of the following.

- Weighing errors may occur due to the influence of static electricity. Note that if the ambient humidity drops below 45%RH, insulators such as plastics are liable to have static electricity. Ground the balance and perform the following as needed.
 - A DC type ionizer that produces no currents of air is available for the BA series balances. Refer to "28. Ionizer (AX-ION-25)" and remove static electricity from the charged sample directly.
 - Increase the relative humidity at the place where the balance is installed.
 - Weigh the sample in a conductive metal container or the like.
 - Wipe off charged materials such as plastic with a damp cloth to suppress static electricity.
- Place the sample in the center of the weighing pan.
- Influence of magnetism may cause weighing errors. When measuring magnetic materials (iron, etc.), keep the sample away from the balance main body by means such as underhook weighing.
- Weighing errors may occur if there is a difference between the ambient temperature and temperature of the sample (and the container). For example, when the room temperature is 20 °C, convection occurs around a Petri dish or watch glass that is 40 °C and the balance displays a value lighter than the actual weight. Before weighing the sample and the container, try to acclimatize them to the ambient temperature.
- Perform the weighing operation carefully and quickly. If measurement takes a long time, error-inducing factors will increase due to changes in temperature and humidity in the weighing chamber, air turbulence or reaction/humidity absorption by the sample.
- Do not leave the sample on the weighing pan for an extended period of time. If a sample is left on the weighing pan for a long time, the measured value will change due to deviation from the zero point caused by environmental changes or due to creep phenomenon.
- When placing a sample on the weighing pan, do not drop it, or do not place a sample greater than the balance weighing capacity. Place the sample in the center of the weighing pan.
- With the highly sensitive BA-6E, the weighing value may fluctuate after the stabilization indicator lights up. It is advisable to set a certain reading time (5 seconds, etc.) after the stabilization indicator lights up and read the value.
- When pressing keys, do not press with a sharp object such as a pen. Instead, press the center of the key with your finger.
- Be sure to press the **RE-ZERO** key before weighing in order to eliminate measurement errors.
- For weighing where impurities will be a problem, it is advisable to prepare samples outside the weighing chamber in order to prevent the substance from scattering inside the weighing chamber.
- Measurement results include error from air buoyancy. The buoyancy of air varies depending on the sample volume, atmospheric pressure, temperature, and humidity. Correct the buoyancy for the most precise measurement.
- Prevent foreign substances such as powder, liquid, and metal pieces from entering the balance.

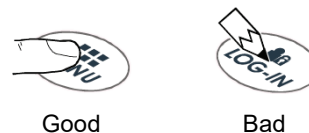
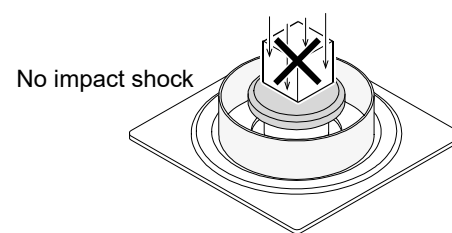
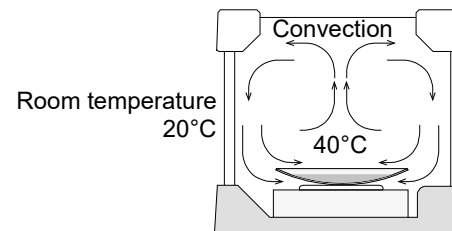
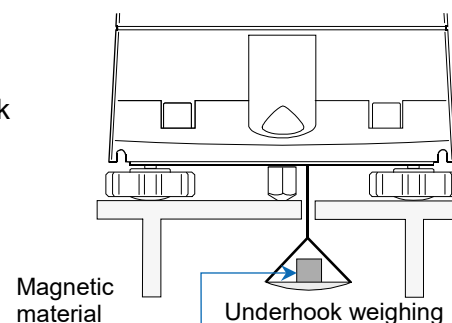
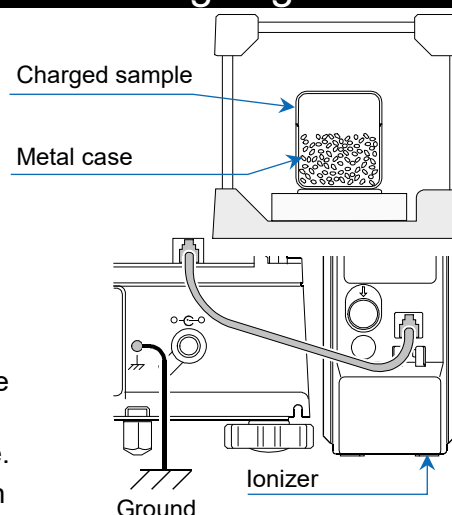

2.5. Precautions after use

- Avoid mechanical shock to the balance.
- Do not disassemble the balance.
- Do not use any strong organic solvents to clean the balance. Clean the balance with a lint free cloth that is moistened with a mild detergent.
- Prevent foreign substances such as powder, liquid and metal pieces from entering the balance.

2.6. Caution on the power supply

- Be sure to warm up the balance before use for at least an hour, or at least four hours for BA-6E/BA-6DE, with the AC adapter connected to the power supply
- The balance is constantly provided with power as long as the AC adapter is connected. The balance is not adversely affected in this state. It is advisable to always keep the balance in this state for accurate weighing.
- Be sure to keep the BA-6E/BA-6DE always in a state where power is being supplied.

2.7. Connection terminals of the display unit

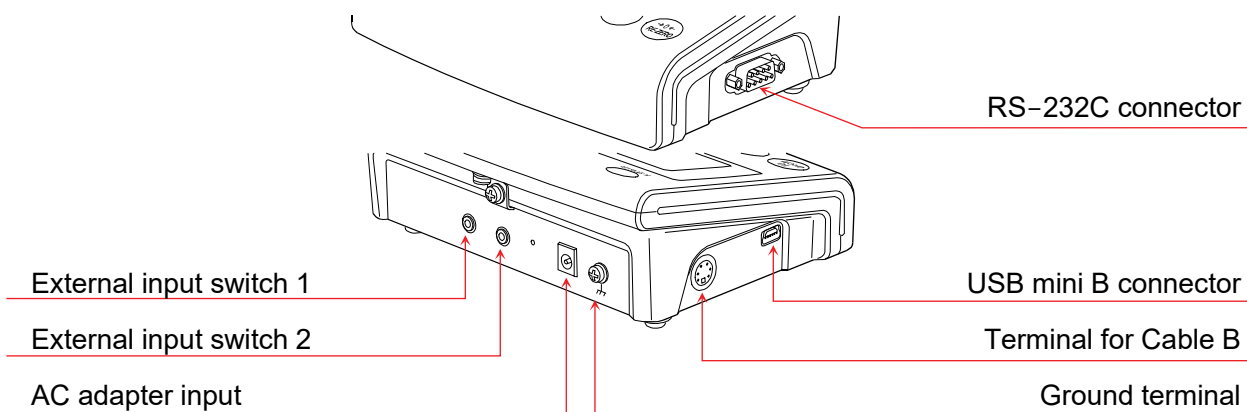

Name	Description
External input switch 1 External input switch 2	A contact input switch. Refer to “16.3 External input terminal”.
AC adapter input	Refer to “2.6 Power supply”.
RS-232C connector	Refer to “16 Interface Specification (Standard)” and “17 Connection with Peripheral Devices”.
USB mini B connector	
Terminal for Cable B	For connection to the weighing unit.
Ground terminal	Refer to “2.4 Precautions during use for more accurate weighing”.

3. Display and Key Panel (Basic Operation)

3.1. Display

Lit display

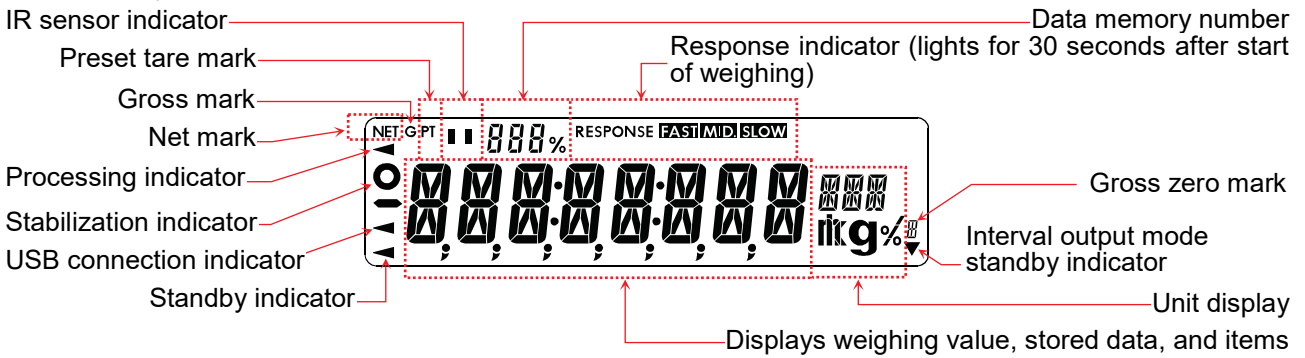

Blinking display

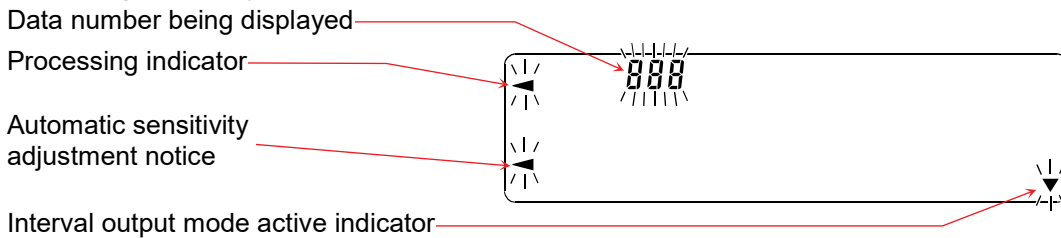

Keys

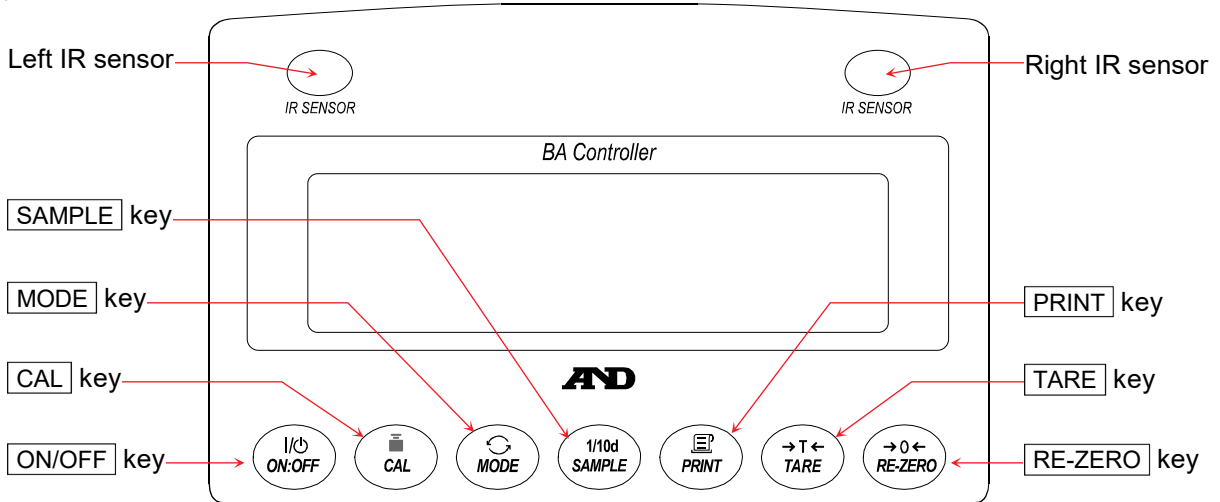

Key operation







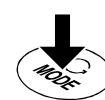

Key operations affect how the balance functions. Normal key operation during measurement is “Press and release the key immediately” or “Press the key”. Please do not “Press and hold the key (for 2 seconds)” unless required.



Press the key (Press and release the key immediately.)



Press and hold the key for 2 seconds.

Key	When pressed and released	When pressed and held (for 2 seconds)
	When the display is turned off, only the standby indicator is displayed. When the display is turned on, weighing is possible. If the password function is enabled, you will be prompted to enter the password when the display is turned on. For details, refer to “14.2. Entering a password at the start of weighing”. The ON:OFF key is active at any time, and pressing this key during operation always turns off the display.	Switches the IR sensors on and off. Refer to “3.2. IR sensors and auto doors”.
	In weighing mode, press this button to turn the digit for readability on and off. In counting or percent mode, press this button to enter the sample storing mode.	<ul style="list-style-type: none"> □ Enters the function table mode. Refer to “8. Function Table”. □ Runs the repeatability check function when pressed and held for another 2 seconds after the function table menu is displayed. Refer to “15. Repeatability Check Function”.
	Switches the units of measure registered in the function table.	Enters Changing Weighing Speed mode. Refer to “5. Response Adjustment / Weighing Speed Setting”.
	Performs sensitivity adjustment of the balance using the internal weight.	Displays the menu related to sensitivity adjustment.
	Stores or outputs the weighing value when stable according to the function table settings. (At factory setting, data output is performed.)	At factory setting, no function is set. The following functions are possible by setting the function table: <ul style="list-style-type: none"> □ Outputs "Title block" and "End block" for GLP/GMP report. Refer to “9. GLP report and ID number”. □ Displays the data memory menu. Refer to “10. Data Memory”.
	Performs tare operation.	
	Sets the displayed value to zero.	
	IR sensor (touchless sensor). It reacts when you bring your hand close to it. Opening and closing of the breeze break door are assigned. For details, refer to “3.2. IR sensors and auto doors”.	

3.2. IR sensors and auto doors

3.2.1. IR sensors

- BA series analytical balances are equipped with IR sensors that allow operation without directly touching the balance display unit. At factory setting, the IR sensors on the left and right of the display are assigned to open and close the breeze break doors. By pressing and holding the **ON:OFF** key (for about 2 seconds), you can switch the IR sensors on and off.

Turning off the IR sensors

- Step 1. In the weighing mode, press and hold the **ON:OFF** key (for about 2 seconds).
- Step 2. **iR OFF** is displayed for about 1 second.
- Step 3. The IR sensor indicator on the upper left turns off.

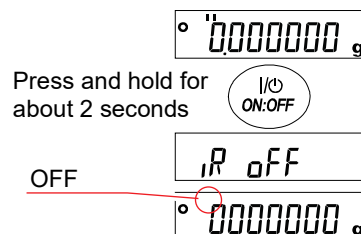

Turning on the IR sensors

- Step 1. In the weighing mode, press and hold the **ON:OFF** key (for about 2 seconds).
- Step 2. **iR ON** is displayed for about 1 second.
- Step 3. The IR sensor indicator on the upper left turns on.

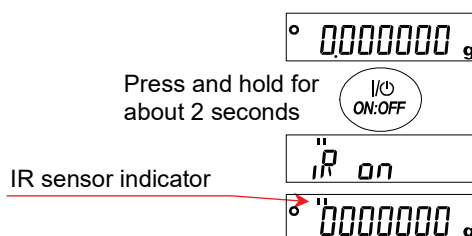

Information. Function table related to the IR sensors and auto doors

- The following settings for the IR sensors and auto doors can be changed in the function table of the balance. For details, refer to "8. Function Table".

Class	Item	Parameter	Description	
<i>E</i> × <i>SW</i> External switch [21]	<i>SW1</i> Ex.SW1 function selection	■ 0 RE-ZERO / PRINT key *	* The AX-SW137-PRINT (sold separately) functions as the PRINT key of the balance when connected. AX-SW137-REZERO (sold separately) functions as the RE-ZERO key of the balance when connected.	
		/ 1 Opens/Closes the left door		
	/ 2 Opens/Closes the right door			
	■ 0 RE-ZERO / PRINT key *			
<i>SW2</i> Ex.SW2 function selection	/ 1 Opens/Closes the left door	■ 1 ON	ON/OFF switching of left and right IR sensors	
				/ 2 Opens/Closes the right door
	0 High sensitivity			Sensitivity adjustment of left and right IR sensors
	■ 1 Medium sensitivity			
/ 2 Low sensitivity				
<i>door</i> Door assignment	0 Straight-setting	■ 1 Cross-setting	Cross-setting means that the breeze break door on the left (right) opens and closes when the IR sensor on the right (left) reacts.	
	/ 1 Fully open			
<i>R-door</i> Auto doors [23]	<i>oPEN</i> Opening position	0 Partially open	Refer to "3.2.2. Auto doors".	
		/ 1 Fully open		
		■ 2 Arbitrary position		

■ Factory setting

The number in [] is the classification number. It is output as an identifier when outputting function table information in batch. Refer to "8.4.1. Batch output of the function table information".

3.2.2. Auto doors

- BA series analytical balances are equipped with auto doors that allow you to open/close the breeze break without touching the doors.
At factory settings, the IR sensors on the left and right of the display are assigned to open and close the breeze break doors on the right and left respectively in the function table "IR sensors (IR-5)".
- At factory setting, the opening position of each breeze break door is set to "Opens to the position the breeze break door was previously opened to (OPEN 2)" in the function table "Auto doors (A-door)".
You can also change the function table of the balance for the doors to be fully open or partially open.
- You can also open and close the breeze break doors with the external switch AX-SW137-PRINT (or AX-SW137-REZERO) connected to the display unit connection terminal EXT.SW1 (or EXT.SW2) and the function table "External input (EXT-SW)".

Opening the breeze break door

Step 1. If you want to open the breeze break door when it is closed, hold your hand over the right (or left) IR sensor.

Step 2. The detection buzzer sounds and the breeze break door on the left (or right) side opens.

Closing the breeze break door

Step 1. If you want to close the breeze break door when it is open, hold your hand over the right (or left) IR sensor.

Step 2. The detection buzzer sounds and the breeze break door on the left (or right) side closes.

Operation overview

The left IR sensor opens/closes the door on the right.

The right IR sensor opens/closes the door on the left.

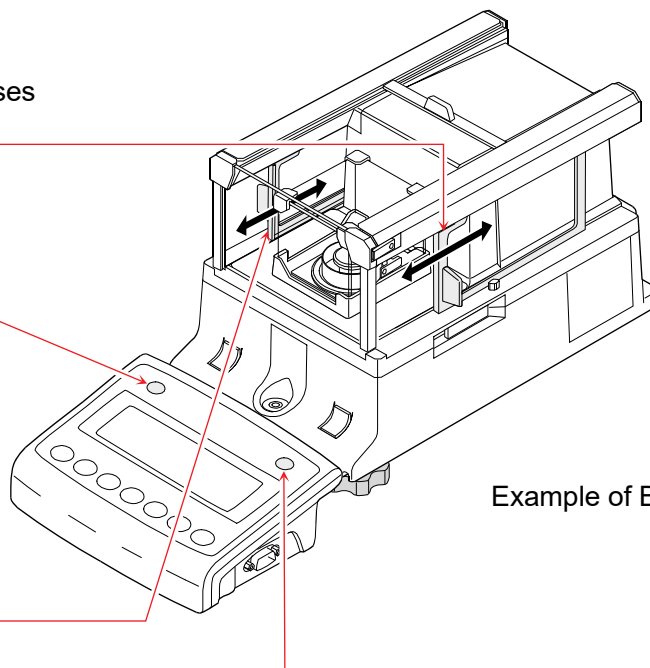

Example of BA-6E / BA-6DE

4. Weighing

4.1. Unit of measure

With the BA series balance, the following units of measure and weighing modes are available:

Note. The units to be displayed and their order can be registered in advance in the function table.

For details, refer to “4.1.1 Storing Units”.

For BA-6E/BA-6DE, the unit is set to switch from "milligram" to "gram" at the factory setting.

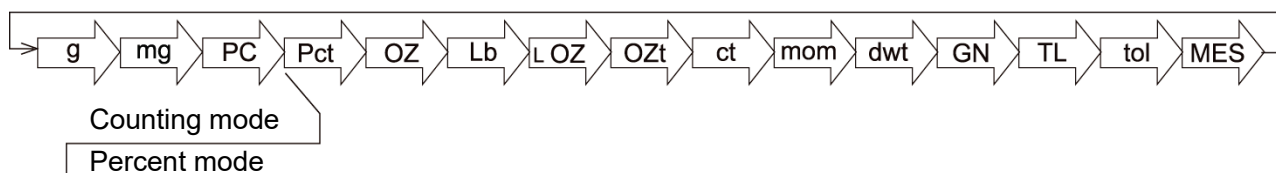

The units of measure or weighing modes can be selected and stored in the function table as described on page 24. Units of measure or weighing modes that are turned off will not be included in the sequence.

Tael has four varieties, one of which can be selected and installed at the factory.

To use your desired unit or mode for weighing operation, press the **MODE** key.

For details about the units and modes, see the table below:

Name (unit, mode)	Abbrev.	Display	Function table (Storing mode)	Conversion factor 1 g =
Gram	g	g	g	1 g
Milligram	mg	mg	mg	0.001 g
Counting mode	PCS	<i>PCS</i>	<i>PCS</i>	–
Percent mode	%	%	%	–
Ounce (Avoir)	OZ	<i>OZ</i>	<i>OZ</i>	28.349523125 g
Troy Ounce	OZt	<i>OZt</i>	<i>OZt</i>	31.1034768 g
Metric Carat	ct	<i>ct</i>	<i>ct</i>	0.2 g
Momme	mom	<i>mom</i>	<i>mom</i>	3.75 g
Pennyweight	dwt	<i>dwt</i>	<i>dwt</i>	1.55517384 g
Grain (UK)	GN	<i>GN</i>	<i>GN</i>	0.06479891 g
Tael (HK general, Singapore)	TL	<i>TL</i>	<i>TL</i>	37.7994 g
Tael (HK jewelry)				37.429 g
Tael (Taiwan)				37.5 g
Tael (China)				31.25 g
Tola (India)	tol	<i>tol</i>	<i>tol</i>	11.6638038 g
Messghal	MES	<i>MES</i>	<i>MES</i>	4.6875 g

The following tables show the capacity and readability for each unit according to the model of the balance.

Unit	BA-6E	
	Precision range	
	Capacity	Readability
Gram	6.20	0.000001
Milligram	6200	0.001
Ounce (Avoir)	0.218	0.0000001
Troy Ounce	0.199	0.0000001
Metric Carat	31.0	0.00001
Momme	1.65	0.000001
Pennyweight	3.98	0.000001
Grain (UK)	95.6	0.00002
Tael (HK general, Singapore)	0.164	0.0000001
Tael (HK jewelry)	0.165	0.0000001
Tael (Taiwan)	0.165	0.0000001
Tael (China)	0.198	0.0000001
Tola (India)	0.531	0.0000001
Messghal	1.32	0.000001

Unit	BA-6DE			
	Precision range		Standard range	
	Capacity	Readability	Capacity	Readability
Gram	2.10	0.000001	6.20	0.00001
Milligram	2100	0.001	6200	0.01
Ounce (Avoir)	0.0740	0.0000001	0.218	0.000001
Troy Ounce	0.0675	0.0000001	0.199	0.000001
Metric Carat	10.5	0.00001	31.0	0.0001
Momme	0.56	0.000001	1.65	0.00001
Pennyweight	1.35	0.000001	3.98	0.00001
Grain (UK)	32.4	0.00002	95.6	0.0001
Tael (HK general, Singapore)	0.0555	0.0000001	0.164	0.000001
Tael (HK jewelry)	0.0561	0.0000001	0.165	0.000001
Tael (Taiwan)	0.0560	0.0000001	0.165	0.000001
Tael (China)	0.0672	0.0000001	0.198	0.000001
Tola (India)	0.180	0.0000001	0.531	0.000001
Messghal	0.448	0.000001	1.32	0.00001

Unit	BA-225	
	Precision range	
	Capacity	Readability
Gram	220	0.00001
Milligram	220000	0.01
Ounce (Avoir)	7.76	0.000001
Troy Ounce	7.07	0.000001
Metric Carat	1100	0.0001
Momme	58.6	0.00001
Pennyweight	141	0.00001
Grain (UK)	3395	0.0002
Tael (HK general, Singapore)	5.82	0.000001
Tael (HK jewelry)	5.87	0.000001
Tael (Taiwan)	5.86	0.000001
Tael (China)	7.04	0.000001
Tola (India)	18.8	0.000001
Messghal	46.9	0.00001

Unit	BA-225D			
	Precision range		Standard range	
	Capacity	Readability	Capacity	Readability
Gram	51.0	0.00001	220	0.0001
Milligram	51000	0.01	220000	0.1
Ounce (Avoir)	1.79	0.000001	7.76	0.00001
Troy Ounce	1.63	0.000001	7.07	0.00001
Metric Carat	255	0.0001	1100	0.001
Momme	13.6	0.00001	58.6	0.0001
Pennyweight	32.7	0.00001	141	0.0001
Grain (UK)	787	0.0002	3395	0.001
Tael (HK general, Singapore)	1.34	0.000001	5.82	0.00001
Tael (HK jewelry)	1.36	0.000001	5.87	0.00001
Tael (Taiwan)	1.36	0.000001	5.86	0.00001
Tael (China)	1.63	0.000001	7.04	0.00001
Tola (India)	4.37	0.000001	18.8	0.00001
Messghal	10.8	0.00001	46.9	0.0001

Unit	BA-125D			
	Precision range		Standard range	
	Capacity	Readability	Capacity	Readability
Gram	51.0	0.00001	120	0.0001
Milligram	51000	0.01	120000	0.1
Ounce (Avoir)	1.79	0.000001	4.23	0.00001
Troy Ounce	1.63	0.000001	3.85	0.00001
Metric Carat	255	0.0001	600	0.001
Momme	13.6	0.00001	32.0	0.0001
Pennyweight	32.7	0.00001	77	0.0001
Grain (UK)	787	0.0002	1851	0.001
Tael (HK general, Singapore)	1.34	0.000001	3.17	0.00001
Tael (HK jewelry)	1.36	0.000001	3.20	0.00001
Tael (Taiwan)	1.36	0.000001	3.20	0.00001
Tael (China)	1.63	0.000001	3.84	0.00001
Tola (India)	4.37	0.000001	10.2	0.00001
Messghal	10.8	0.00001	25.6	0.0001

4.1.1. Storing units

The units of measure or weighing modes can be selected and stored in the function table. The sequence of displaying the units or modes can be arranged to fit the frequency of use. The units are stored in non-volatile memory, even if the AC adapter is removed.

Select a unit or mode and arrange the sequence of display as follows:

Step 1. Press and hold the **SAMPLE** key until **bRSFnC** of the function table is displayed, then release the key.

Step 2. Press the **SAMPLE** key several times to display **Unit**.

Step 3. Press the **PRINT** key to enter the unit selection mode.

Step 4. Specify a unit or mode in the order to be displayed using the following keys.

SAMPLE key Displays the units sequentially.

RE-ZERO key..... Specifies a unit or mode. The stabilization indicator **o** appears when the displayed unit or mode is specified.

If the key is pressed for the unit already selected, the stability mark does not appear.

Step 5. Press the **PRINT** key to store the units or modes. The balance displays **End** and then displays the next menu of the function table.

Step 6. Press the **CAL** key to exit the function table. Then the balance returns to the weighing mode with the selected unit.

Step 7. For weighing with a different unit or mode, press the **MODE** key.

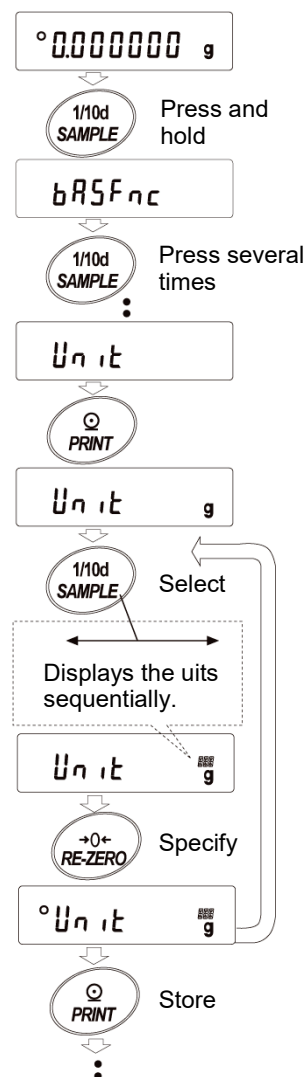

4.1.2. Unit setting example

The example below shows how to set the units in the order with "g" (gram) as the first unit followed by pcs (counting mode).

- Step 1. Press and hold the **SAMPLE** key until **bRSFnC** of the function table is displayed, then release the key.
- Step 2. Press the **SAMPLE** key several times to display **Unit**.
- Step 3. Press the **PRINT** key to enter the unit selection mode.
- Step 4. Press the **RE-ZERO** key to specify the unit of "g"
The stabilization indicator **o** appears when the unit is specified.
- Step 5. Press the **SAMPLE** key to display **Unit^{PCS}**.
- Step 6. Press the **RE-ZERO** key to specify the unit of pcs.
The stabilization indicator **o** appears when the unit is specified.
- Step 7. Press the **PRINT** key to store the units.
The balance displays **End** and then displays the next menu item of the function table.
- Step 8. Press the **CAL** key to exit the function table. Then the balance returns to the weighing mode with g, the unit selected first.
- Step 9. Press the **MODE** key to toggle between g and pcs.
(g → pcs)

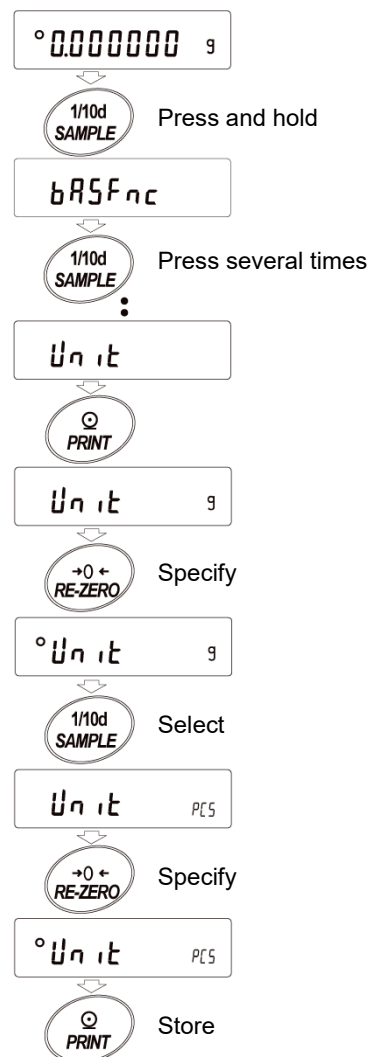

4.2. Basic operation

- Step 1. Press **MODE** key to select a unit of measure.
Here, **g** is selected for BA-6E/BA-6DE as an example.
- Step 2. Place a container on the weighing pan if necessary. Press the **RE-ZERO** key to cancel the weight (tare). The balance displays **°0000000 g**. (The decimal separator position depends on the balance model.)
- Step 3. Place a sample on the pan or in the container. Wait for the stabilization indicator **●** to be displayed. Read the value.
- Step 4. Remove the sample and container from the weighing pan.

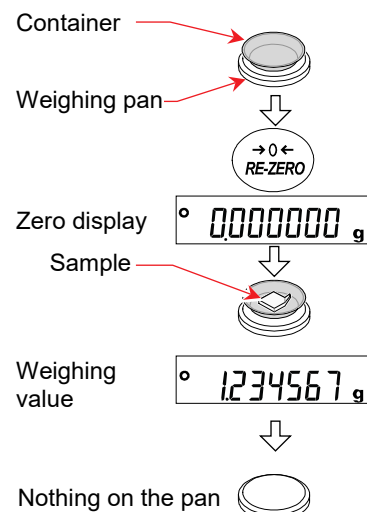

Note

- Press the **SAMPLE** key to turn on or off the digit for the readability.
- The weighing data can be stored in memory by changing the function table. For details, refer to "10. Data Memory".
- If the **ON:OFF** key is pressed to start weighing with a container placed on the weighing pan when the display is turned off, the balance automatically cancels the weight (tare) and displays **°0000000 g** (The condition is being within the power-on zero range. See the next section.)

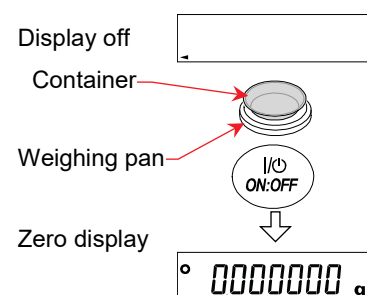

4.2.1. Zero-point, tare, and weighing range

Entering the weighing mode

The balance will determine the reference zero point when the **ON:OFF** key is pressed to enter the weighing mode.

Depending on the load condition at that time, the balance automatically judges whether to set the zero-point or to tare. The condition for determining which is used is "power-on zero range", and when power-on zero range is exceeded, the tare operation is performed.

Re-zero operation

By pressing the **RE-ZERO** key, the displayed value can be set to zero.

The re-zero operation with the **RE-ZERO** key will automatically judge whether to set the zero-point or to tare.

The condition for determining which is used is "zero range", and when zero range is exceeded, the tare operation is performed.

Weighing range

The weight range that the balance can weigh and display varies depending on the model. When the gross weight exceeds the maximum display for the model, **E** is displayed to indicate that the

weighing range is exceeded. When exceeded in the negative direction, -E is displayed.
Gross weight = Net weight (weighing value after tare operation) + Tare weight

Model	Power-on zero range	Zero range	-E display range
BA-6E/BA-6DE	Approx. ± 0.6 g	Approx. -0.6 g to +0.1 g	Approx. less than -0.6 g
BA-225/BA-225D	Approx. ± 22 g	Approx. -22 g to +4.4 g	Approx. less than -22 g
BA-125D	Approx. ± 12 g	Approx. -12 g to +2.4 g	Approx. less than -12 g

4.3. Smart range function

The smart range function for BA-6DE/BA-225D/BA-125D consists of the standard range and precision range (high resolution).

Smart range

The range can switch automatically between the standard range and precision range (high resolution), depending on the value displayed.

Pressing the **RE-ZERO** key to set the displayed value to zero allows for weighing in the precision range, regardless of the tare value. The range can be fixed to the standard range by pressing the **SAMPLE** key.

Operation example

Step 1. Start weighing in the precision range.

Press the **RE-ZERO** key to set the display to zero and enable the precision range.

Step 2. Place a container on the weighing pan.

When the displayed value exceeds the precision range, the balance automatically switches to the standard range.

Step 3. Enable the precision range.

To enable the precision range, press the **RE-ZERO** key to set the display to zero.

Step 4. Place a sample in the container.

If the weighing value does not exceed the precision range, the sample can be weighed in the precision range.

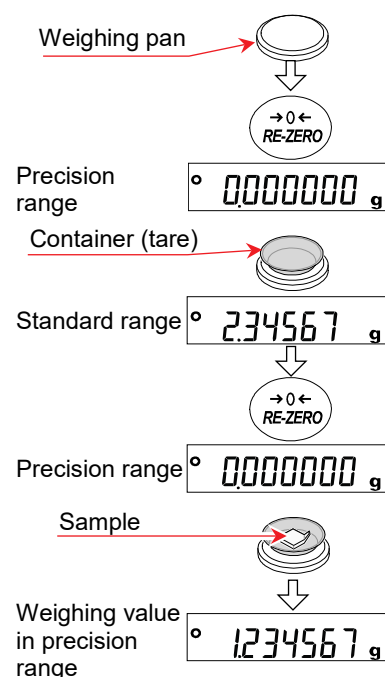

Precision range and standard range

Model	Unit	Precision range (after the RE-ZERO key is pressed)	Standard range
BA-6DE	Gram (g)	0.000000 g ~ 2.100009 g	2.10001 g ~ 6.20008 g
	Milligram (mg)	0.000 mg ~ 2100.009 mg	2100.01 mg ~ 6200.08 mg
BA-225D	Gram (g)	0.00000 g ~ 51.00009 g	51.001 g ~ 220.008 g
	Milligram (mg)	0.00 mg ~ 51000.09 mg	51001 mg ~ 220008 mg
BA-125D	Gram (g)	0.00000 g ~ 51.00009 g	51.001 g ~ 120.008 g
	Milligram (mg)	0.00 mg ~ 51000.09 mg	51001 mg ~ 120008 mg

4.4. Counting mode (PCS)

This is the mode to determine the number of objects in a sample. Based on the reference sample unit weight (weight per piece), the balance calculates and displays how many pieces the sample weight corresponds to. The smaller the variation in the unit weight of sample pieces is, the more accurate the count will be. The balance is equipped with the Automatic Counting Accuracy Improvement (ACAI) function to improve the counting accuracy.

- Note. It is recommended that the unit weight (weight per piece) of the sample should be 0.1 mg or more.
 If there is a large variation in the unit weight of sample pieces, it may not be possible to count accurately.
 If a large error is found in the counting measurement, try a method such as performing ACAI frequently or multiple measurements.

Selecting the counting mode

Step 1. Press the **MODE** key to set the unit display to "PCS" (pieces).

Storing a unit weight

Step 2. Press the **SAMPLE** key to enter the unit weight storing mode.

Note that even in the unit weight storing mode, pressing the **MODE** key switches to the next mode.

Step 3. Select the number of sample pieces using the **SAMPLE** key. (10 pcs → 25 pcs → 50 pcs → 100 pcs → 5 pcs)

Note that a greater number of sample pieces at time of unit weight storing will yield more accurate counting result since the sample unit weight is usually considered to vary slightly.

Step 4. Place a container on the weighing pan, if necessary.

Press the **RE-ZERO** key to set the display to **25 0**. (In this example, the number of sample pieces to store is set to 25.)

Step 5. Place the displayed number of sample pieces on the weighing pan/container.

Step 6. Press the **PRINT** key to store the unit weight. The balance displays the count. (In this example, **25 PCS** is displayed when 25 is set.)

The balance prompts to add more sample pieces if it judges that the loaded sample is too light (resulting in large counting error). Add more sample pieces until the displayed number is reached, and then press the **PRINT** key again. When the unit weight is stored correctly, the balance displays the count.

- If the balance judges that the sample is too light to be stored as the unit weight, it displays **Lo**.
- The stored unit weight is stored in nonvolatile memory even if the power is removed.

Counting mode

Step 7. Counting operation is now possible.

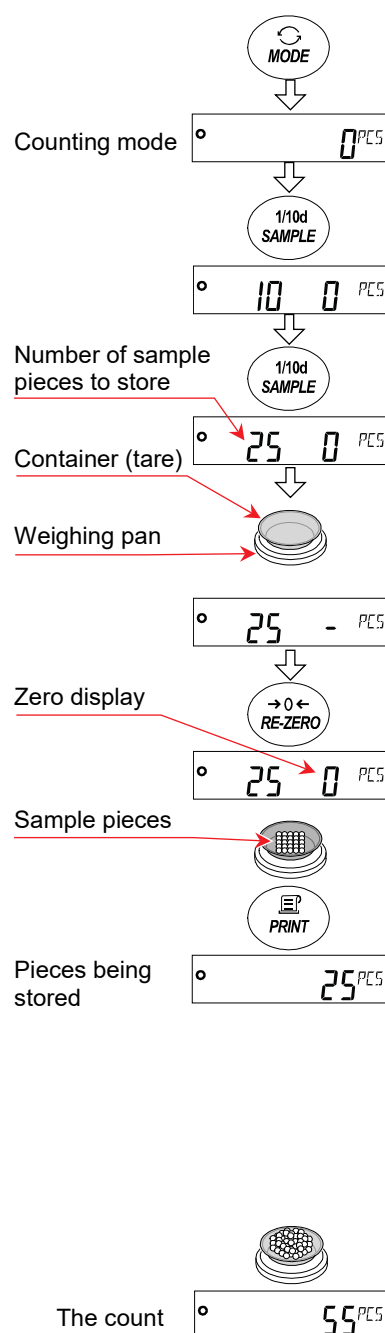

Automatic Counting Accuracy Improvement (ACAI)

This function automatically improves the counting accuracy each time the number of sample pieces is increased. (Errors will be reduced as variations in sample weight are averaged.)

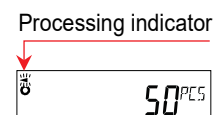

After storing the unit weight in step 6, proceed to step 8 below.

- Step 8. Add a few sample pieces. The processing indicator then turns on. (Three or more pieces are required in order to prevent errors. The processing indicator does not turn on if overloaded. Add approximately the same number of sample pieces as displayed.)
- Step 9. Do not touch or move the sample pieces while the processing indicator is blinking. (The accuracy is being updated.)
- Step 10. The accuracy is updated after the processing indicator turns off. Each time this process is repeated, the counting accuracy will improve further. The range of ACAI after exceeding 100 is not predetermined. Add approximately the same number of sample pieces as displayed.
- Step 11. Remove all the sample pieces used with ACAI from the weighing pan and start counting work.
- Note. Do not change units during ACAI processing.

Storing unit weights

By using the data memory function, up to 50 unit weights can be stored.

- Step 1. Set the "Data memory (dAtA)" item of the function table to "Stores unit weight in counting mode (dAtA 1)". Refer to "8. Function Table".
- Step 2. The selected registration number for the stored unit weight is displayed in "P nn". In place of "nn", a number from 01 to 50 is displayed.
- Step 3. Press and hold the **PRINT** key for 2 seconds to enter the mode for changing the unit weight registration number.
- RE-ZERO** key Increases the value of registration number. (+)
 - MODE** key Decreases the value of registration number. (-)
 - PRINT** key Confirms the displayed registration number.
 - CAL** key Cancels the displayed registration number.
 - SAMPLE** key Stores the weight with the displayed registration number.
- Step 4. Store the unit weight as necessary.
- Step 5. Multiple unit weights can be stored by assigning individual unit weight registration numbers.

Unit weight registration number

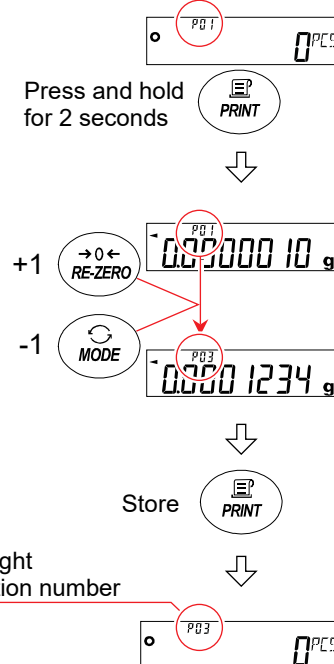

Unit weight registration number

Note

- The unit weight can be read by the "UN: nn" command. "nn": 01 - 50
- The read unit weight can be output with the "?UW" command and changed with the "UW: " command.
- For details about the "UN:nn" and "?UW" commands, refer to "21.1. Control commands". nn: 01 - 50.

Caution. The ACAI function does not work for the read unit weight.

4.5. Percent mode (Percent weighing mode)

The percent mode displays the weighing value in a percentage compared with a reference mass as 100%. This is useful for target weighing or sample variance checks.

Selecting the percent mode

Step 1. Press the **MODE** key to select the unit **%** (percent mode).

Storing a reference mass as 100%

(Preparation for percent weighing)

Step 2. Press the **SAMPLE** key to enter the mode for storing a 100% reference mass.

Note. Even in registration mode, pressing the **MODE** key switches to the next mode.

Step 3. Place a container (tare) on the weighing pan, if necessary.

Press the **RE-ZERO** key to set the zero display to

100 0 %.

Step 4. Place a sample for the 100% reference mass on the weighing pan/container.

Step 5. Press the **PRINT** key to store the 100% reference mass.

The balance displays the stored 100% reference mass as

10000 %.

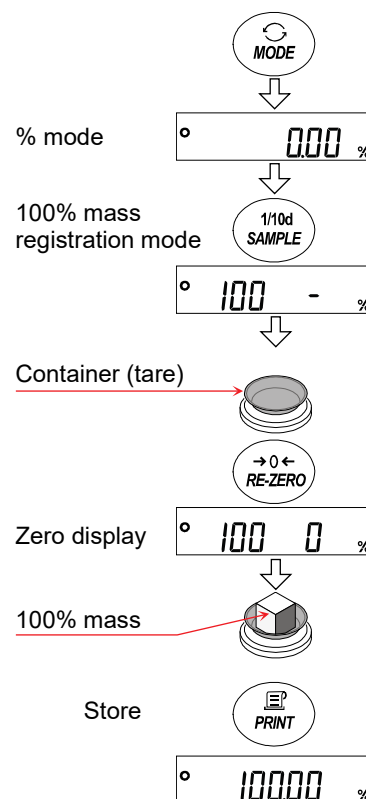

Caution

- **Lo** appears if the balance judges that the sample is too light to be stored as the 100% reference mass.
- The decimal separator position varies according to the 100% reference mass.

Model	100% reference mass	Decimal separator position
BA-6E/BA-6DE	0.0010 g ~ 0.0099 g	1 %
	0.0100 g ~ 0.0999 g	0.1 %
	0.1000 g ~	0.01 %
BA-225/BA-225D/ BA-125D	0.0100 g ~ 0.0999 g	1 %
	0.1000 g ~ 0.9999 g	0.1 %
	1.0000 g ~	0.01 %

Note. The stored 100% reference mass is stored in nonvolatile memory even if the power is removed.

Percent weighing

Step 6. Perform a percent weighing operation.

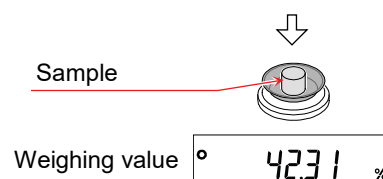

5. Response Adjustment/Weighing Speed Setting

Disturbances such as draft and vibration at the place where the balance is installed affect weighing. In the response adjustment settings, the response characteristics of the balance can be set in three stages according to the disturbance.

Indicator	Function table	Response characteristic
FAST	[Cond 0]	Fast response. Low display stability.
MID.	[Cond 1]	↓ ↑
SLOW	[Cond 2]	Slow response. High display stability.



5.1. Response adjustment

Response adjustment can be changed by the following method.

- Step 1. Press and hold the **MODE** key for 2 seconds until **RESPONSE** is displayed, and then press the **MODE** key again.
- Step 2. Press the **MODE** key to select the desired setting. (**FAST**, **MID** or **SLOW** can be selected.)
- Step 3. Wait until **End** is displayed. Then, the balance returns to weighing mode and displays the updated response indicator for a moment (for about 30 seconds).

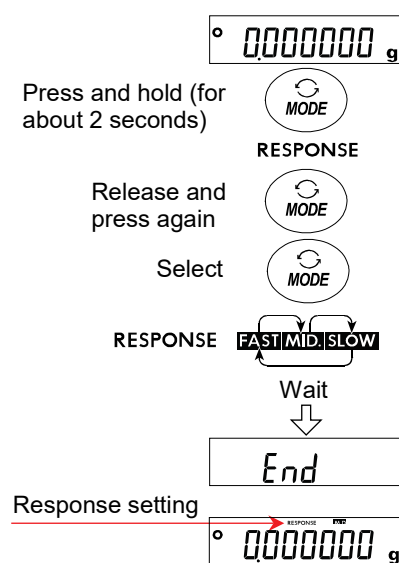

Information

When the response adjustment is set, "Condition ([Cond])" and "Display refresh rate ([SPd])" in "Basic Function ([bR5FnC])" of the function table are changed as shown below.

Display	Condition [Cond]	Display refresh rate [SPd]	Stability band width [St-b]
FAST	0	1	2
MID.	1	0	1
SLOW	2	0	1

To use in a combination other than the above, set individually in the function table. For the setting method, refer to "8. Function Table".

6. Sensitivity Adjustment/Calibration Test

- Since the balance's resolution is high, weighing values may change due to gravity and daily environmental changes. It is necessary to perform sensitivity adjustment with the weight in order to keep the weighing values from changing even if gravity or the environment changes. It is recommended that you perform sensitivity adjustment if the balance is installed for the first time or relocated, or when the weighing values change significantly in daily check, etc.
- Sensitivity adjustment means to adjust the weighing value of the balance using the reference weight or internal weight.
- Calibration test is to weigh with the reference weight and compare how much the result deviates from the reference value. Note that sensitivity adjustment is not performed in calibration test.

Sensitivity adjustment

Automatic sensitivity adjustment

Adjusts the balance automatically using the internal weight according to ambient temperature change, set time or interval time.

Sensitivity adjustment using the internal weight

Adjusts the balance using the internal weight, with a single touch.

Sensitivity adjustment using an external weight

Adjusts the balance using your external weight

Calibration test

Calibration test with an external weight

Checks the accuracy of weighing using your external weight and outputs the result.
Note that sensitivity adjustment is not performed.

Calibration test with an internal weight

Checks the accuracy of weighing using the internal weight and outputs the result.
Note that sensitivity adjustment is not performed.

Caution for sensitivity adjustment/calibration test

- Do not allow vibration or drafts to affect the balance during sensitivity adjustment or calibration test.
- The GLP/GMP (etc.) compliant report can be output in sensitivity adjustment/calibration test. To output the GLP/GMP compliant report, you need to set "GLP output (*INF0*)" in the function table and prepare a personal computer or optional printer. A timestamp (clock and calendar) is available for the GLP output using the clock function of the balance. If the time/date is not correct, adjust the clock by referring to "[8.4. Clock and calendar function](#)" in "[8. Function Table](#)". The calibration test is a function that is available only when the output of GLP/GMP (etc.) compliant report is set.
- By setting "Data memory (*DATA*)" of the function table, the data of sensitivity adjustment report and calibration test report can be stored in memory.

Caution when using your external weight

- The accuracy of the weight used in sensitivity adjustment affects the accuracy of the balance after sensitivity adjustment.
- Select a weight to be used for sensitivity adjustment and calibration test from the table below.

Model	Usable weight	Factory setting	Adjustable range
BA-6E/BA-6DE	1 g, 2 g, 5 g	5 g	-3.000 mg ~ +3.099 mg
BA-225/BA-225D	10 g, 20 g, 50 g, 100 g, 200 g	200 g	-15.00 mg ~ +15.99 mg
BA-125D	10 g, 20 g, 50 g, 100 g	100 g	

Display

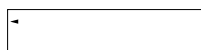

This indicator means the balance is measuring sensitivity adjustment data/calibration test data. Do not allow vibration or drafts to affect the balance while this indicator is displayed.

6.1. Automatic sensitivity adjustment

This function automatically adjusts the sensitivity of the balance according to ambient temperature change, set time or interval time using the internal weight. It works even when the display is off.

- For the automatic sensitivity adjustment mode, "Temperature change ([FNC 0])", "Set time ([FNC 1])", or "Interval time ([FNC 2])" can be set in "Sensitivity adjustment mode ([FNC])" of the function table.
- For the set time, "Set time 1 ([t ME 1])" and "Set time 2 ([t ME 2])" are available in the function table.
- The Interval time can be set in the range of 0.5 hours to 24 hours in "Interval time ([int])" of the function table.
- After sensitivity adjustment, the balance will output the sensitivity adjustment report and store the data as set in the function table.

For the sensitivity adjustment report output, the GLP/GMP (etc.) compliant report is output as set in "GLP output ([nFD])" of the function table.

The data memory function stores the sensitivity adjustment report as set in "Data memory function ([dRtR])" of the function table.

For details, refer to "GLP output ([nFD])" and "Data memory function ([dRtR])" of the function table.

Caution If something is on the weighing pan, the balance itself will judge that it is in use and will not perform automatic sensitivity adjustment.

The criteria for performing automatic sensitivity adjustment are as follows.

Model	Range
BA-6E/BA-6DE/BA-225/BA-225D/BA-125D	Less than 0.1 g

To maintain the correct sensitivity adjustment of the balance, do not place anything on the weighing pan while not in use.



The automatic sensitivity adjustment notice (the ◀ indicator blinking) indicates that the automatic sensitivity adjustment will start. If the balance is not in use, after blinking for a while, the balance will start automatic sensitivity adjustment using the internal weight. (The blinking duration depends on the environment.)

Tips

Although it is possible to continue using the balance even while the automatic sensitivity adjustment notice (the ◀ indicator) is blinking, use after sensitivity adjustment is completed is advisable in order to maintain the weighing accuracy.

"Prohibit automatic sensitivity adjustment" or "Allow automatic sensitivity adjustment" can be selected in the setting described in "7. Function Selection Switch and Initialization".

6.1.1. Inputting the set time

Step 1. Press and hold the **[SAMPLE]** key (for 2 seconds) to display **bR5Fnc**.

Step 2. Press the **[SAMPLE]** key several times to display **Auto CAL**.

Step 3. Press the **[PRINT]** key to display **° [Fnc] t^{EMP}**.

Step 4. With **[Fnc]** displayed, press the **[RE-ZERO]** key several times to display **° [Fnc] t^{ME}**.

Step 5. Press the **[SAMPLE]** key to display the set time 1 **[t ME 1]**.

Step 6. Press the **[PRINT]** key to enter the set time 1 setting mode.

Step 7. With **[THI]** displayed, press the **[RE-ZERO]** key. The currently set time is displayed.

Step 8. Using the following keys, set the time (in 24-hour format) to perform sensitivity adjustment.

[RE-ZERO] (+) key	Changes the value of the blinking digit
[MODE] (-) key	Changes the value of the blinking digit
[SAMPLE] key	Selects the digit to blink.
[PRINT] key	Stores the new time setting.
[CAL] key	Cancel the new time setting.

Step 9. Press the **[PRINT]** key to display **End**.

Step 10. To set the set time 2, display the set time 2 **[t ME2]** and repeat the steps 6 to 9.

Step 11. To return to weighing mode, press the **[CAL]** key twice.

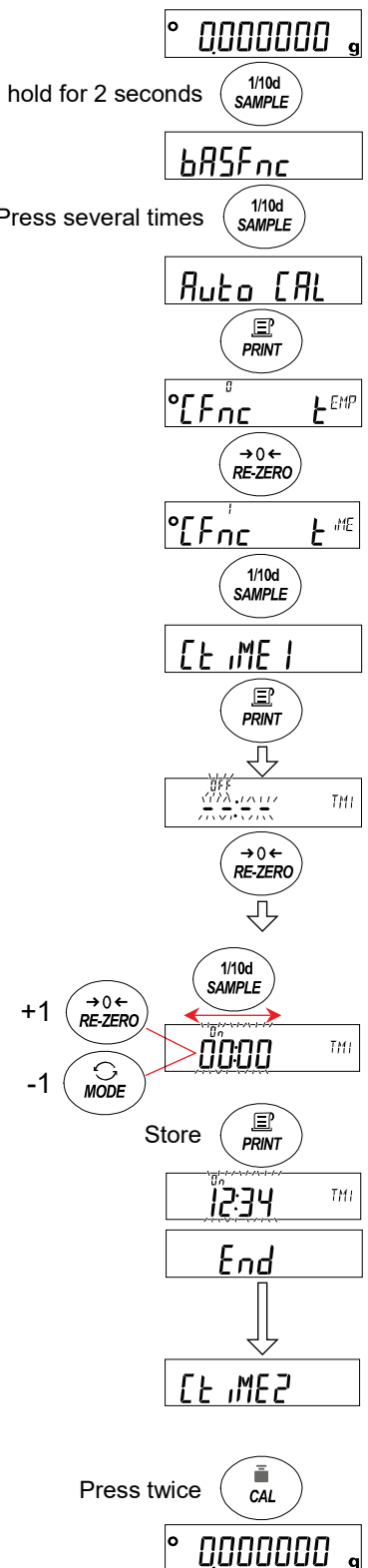

6.1.2. Clearing the set time

Refer to steps 1 to 5 in "6.1.1. Inputting the set time" on the previous page and display .

Step 12. Press the **PRINT** key to display the currently set time.

Step 13. Press the **MODE** key to display .

Step 14. Press the **PRINT** key to display .

Step 15. Press the **CAL** key twice to return to weighing mode.

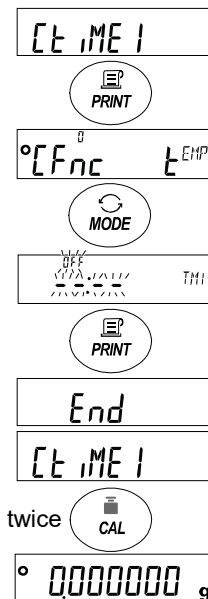

6.1.3. Setting the interval time

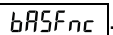
Step 1. Press and hold the **SAMPLE** key (for 2 seconds) to display .

Press and hold (for 2 seconds) 

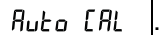
Step 2. Press the **SAMPLE** key several times to display .

Press several times 

Step 3. Press the **PRINT** key to display .

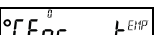
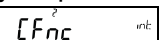

Step 4. With  displayed, press the **RE-ZERO** key several times to display .

Press several times 

Step 5. Press the **SAMPLE** key to display .

Press several times 

Step 6. Press the **RE-ZERO** key several times to set the interval time (0.5 hours to 24 hours) to perform sensitivity adjustment. For the correspondence between the set value and interval time, refer to the correspondence table on the next page.

Press several times 

Step 7. Press the **PRINT** key to display .

Step 8. Press the **CAL** key to return to weighing mode.

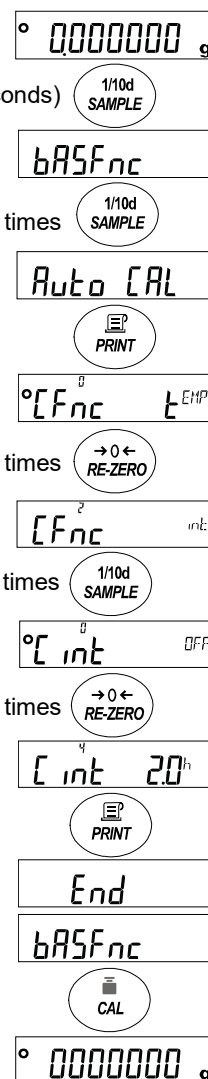

Correspondence table between the set value and interval time of the item [int].

Item	Parameter	Description
[int]	0	Off
	1	0.5-hour interval time
	2	1.0-hour interval time
	3	1.5-hour interval time
	4	2.0-hour interval time
	5	2.5-hour interval time
	6	3.0-hour interval time
	7	3.5-hour interval time
	8	4.0-hour interval time
	9	4.5-hour interval time
	10	5.0-hour interval time
	11	5.5-hour interval time
12	6.0-hour interval time	

Parameter (e.g. 6.0 hours)

Item

[int] 6.0^h

Item	Parameter	Description
[int]	13	7.0-hour interval time
	14	8.0-hour interval time
	15	9.0-hour interval time
	16	10.0-hour interval time
	17	11.0-hour interval time
	18	12.0-hour interval time
	19	14.0-hour interval time
	20	16.0-hour interval time
	21	18.0-hour interval time
	22	20.0-hour interval time
	23	22.0-hour interval time
	24	24.0-hour interval time

6.2. Sensitivity adjustment using the internal weight

Sensitivity adjustment using the internal weight can be performed with one key press.

- Step 1. Be sure to warm up the balance with nothing on the weighing pan for at least an hour, or at least four hours for BA-6E/BA-6DE, with the AC adapter connected to the power supply.
- Step 2. Press the [CAL] key. The balance displays [RL in].
- Step 3. The balance automatically performs sensitivity adjustment using the internal weight. Do not apply vibration and the like to the balance.
- Step 4. After sensitivity adjustment, the balance will output the "sensitivity adjustment report" and store the data as set in the function table.
 For the "sensitivity adjustment report output", a GLP/GMP, etc. compliant report is output as set in "GLP output (INF0)" of the function table.
 The data memory function stores the "sensitivity adjustment report" as set in "Data memory function (dMEm)" of the function table.
 For details, refer to "GLP output (INF0)" and "Data memory function (dMEm)" of the function table.
- Step 5. The balance returns automatically to weighing mode.

About the internal weight

The value of the internal weight may change due to factors such as the operating environment and aging.

Correct the internal weight value as necessary by referring to ["6.7. Correcting the internal weight value"](#).

In order to maintain the weighing accuracy, it is advisable to perform sensitivity adjustment regularly by referring to ["6.4. Sensitivity adjustment using an external weight"](#).

6.3. Calibration test using the internal weight

This function checks the accuracy of weighing using the internal weight. (Note that calibration test does not perform sensitivity adjustment.)

The output of GLP/GMP (etc.) compliant report for check result is a function that is available only when the function table ($inf_0 1$, $inf_0 2$) is set.

Step 1. Warm up the balance with nothing on the weighing pan for at least an hour, or at least four hours for BA-6E/BA-6DE, with the AC adapter connected to the power supply.

Step 2. Press and hold the **CAL** key for 2 seconds until **[[in** is displayed, then release the key.

Step 3. The balance checks the zero point.
Do not apply vibration and the like to the balance.

Step 4. The checked value of the zero point is displayed.

Step 5. The balance checks the full-scale point.
Do not apply vibration and the like to the balance.

Step 6. The checked value of the full-scale point is displayed.
The reference values are shown below.
When the displayed full-scale point value is within the normal range, it means that the sensitivity adjustment was performed correctly with the internal weight.

Model	Full-scale point	Normal range
BA-6E/BA-6DE	5.000000 g	±0.02 mg
BA-225/BA-225D/BA-125D	100.0000 g	±0.2 mg

Step 7. After calibration test, the balance will output the "calibration test report" and store the data as set in the function table.
For the output of "calibration test report", the GLP/GMP (etc.) compliant report is output as set in "GLP output (inf_0)" of the function table.
For details, refer to "GLP output (inf_0)" of the function table.

Step 8. The balance automatically returns to weighing mode.

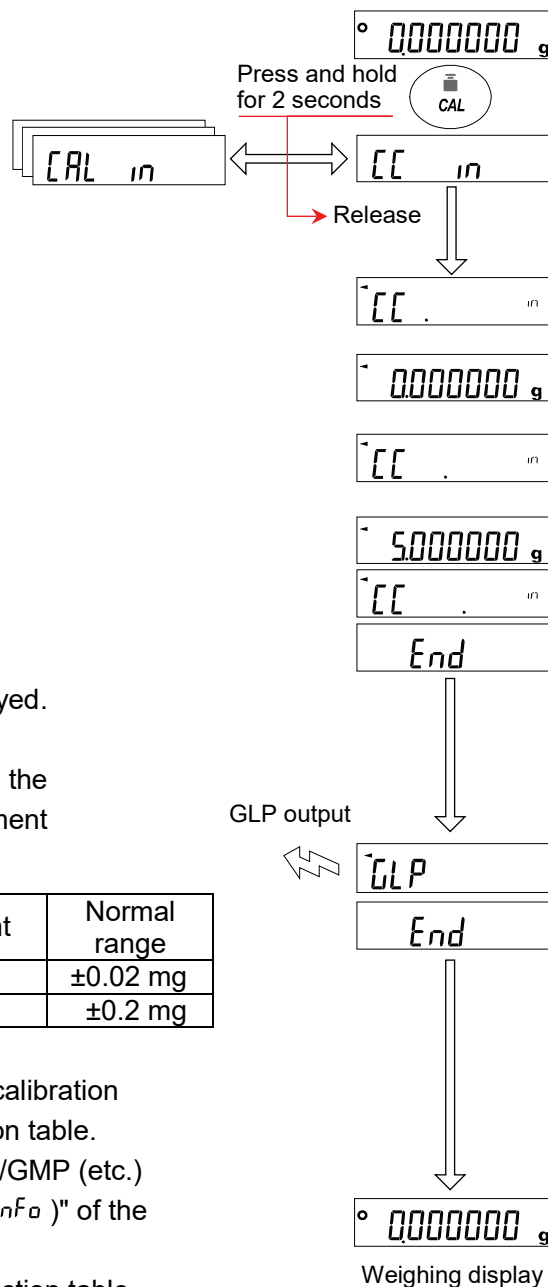

6.4. Sensitivity adjustment using an external weight

This function performs sensitivity adjustment of the balance using your external weight.

Step 1. Warm up the balance with nothing on the weighing pan for at least an hour, or at least four hours for BA-6E/BA-6DE, with the AC adapter connected to the power supply.

Step 2. Press and hold the **[CAL]** key for 2 seconds until **[CALout]** is displayed, then release the key.

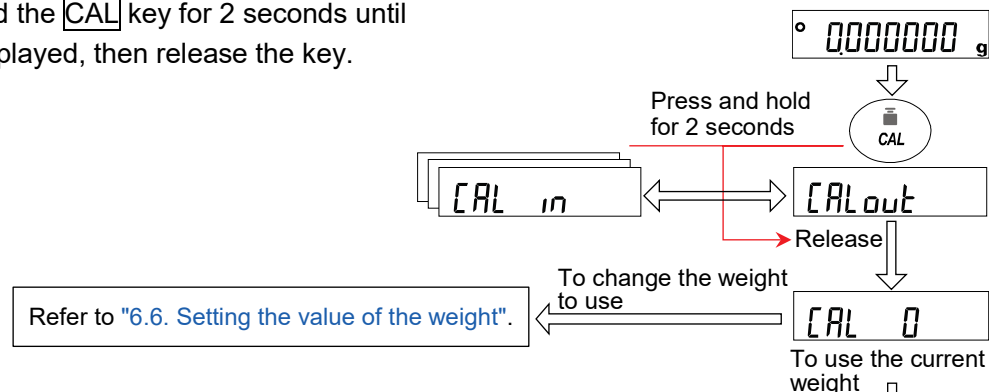

Step 3. Make sure that nothing is on the weighing pan and press the **[PRINT]** key.

Step 4. The balance measures the zero point.
Do not apply vibration and the like to the balance.

Step 5. The value for sensitivity adjustment is displayed in grams.

Step 6. Place the external weight on the weighing pan and press the **[PRINT]** key to measure it.

Step 7. The balance measures the value for sensitivity adjustment. Do not apply vibration and the like to the balance.

Step 8. Remove the external weight from the weighing pan.

Step 9. After sensitivity adjustment, the balance will output the “sensitivity adjustment report” and store the data as set in the function table.

For the output of “sensitivity adjustment report”, the GLP/GMP (etc.) compliant report is output as set in “GLP output (INF0)” of the function table.

The data memory function stores the “sensitivity adjustment report” as set in “Data memory function (dARR)” of the function tab

For details, refer to “GLP output (INF0)”, “Data memory function (dARR)” of the function table.

Step 10. The balance returns automatically to weighing mode.

Step 11. Place the external weight on the weighing pan again to check if it is within the set value ± 2 d.

If it is not within the range, start over from the first step of this procedure in the appropriate ambient conditions.

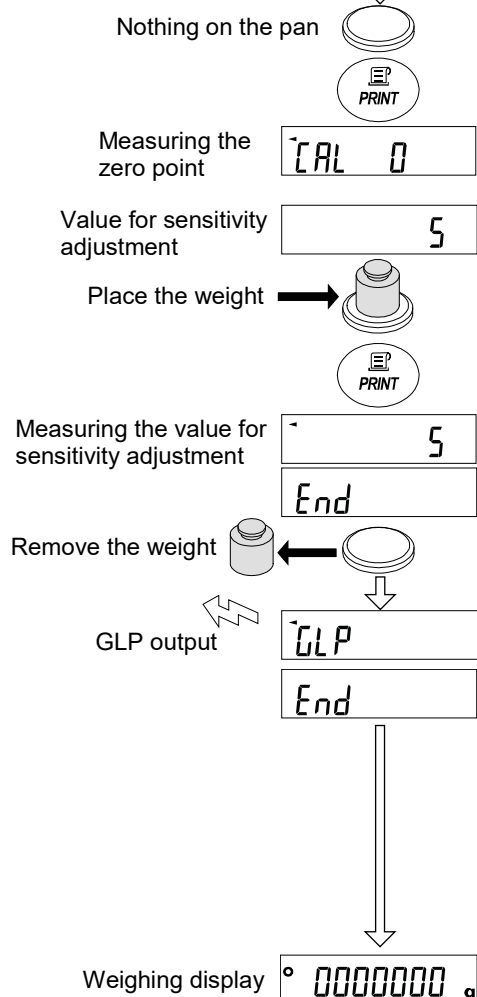

6.5. Calibration test using an external weight

This function checks the accuracy of weighing using your external weight. (Note that calibration test does not perform sensitivity adjustment.)

The output of GLP/GMP (etc.) compliant report for check result is a function that is available only when the function table (INF 1, INF 2) is set.

Step 1. Warm up the balance with nothing on the weighing pan for at least an hour, or at least four hours for BA-6E/BA-6DE, with the AC adapter connected to the power supply.

Step 2. Press and hold the **CAL** key for 2 seconds until **[[out** is displayed, then release the key.

Refer to "6.6. Setting the value of the weight".

Step 3. Make sure that nothing is on the weighing pan and press the **PRINT** key. The balance measures the zero point. Do not apply vibration and the like to the balance.

Step 4. The measured value of the zero point is displayed for a few seconds.

Step 5. The value of the external weight to use is displayed in grams. Place the external weight on the weighing pan and press the **PRINT** key to measure it. Do not apply vibration and the like to the balance.

Step 6. The measured value of the external weight is displayed for a few seconds.

Step 7. Remove the external weight from the weighing pan.

Step 8. After calibration test, the balance will output the "calibration test report" and store the data as set in the function table. For the output of "calibration test report", the GLP/GMP (etc.) compliant report is output as set in "GLP output (INF)" of the function table. For details, refer to "GLP output (INF)" of the function table.

Step 9. The balance automatically returns to weighing mode.

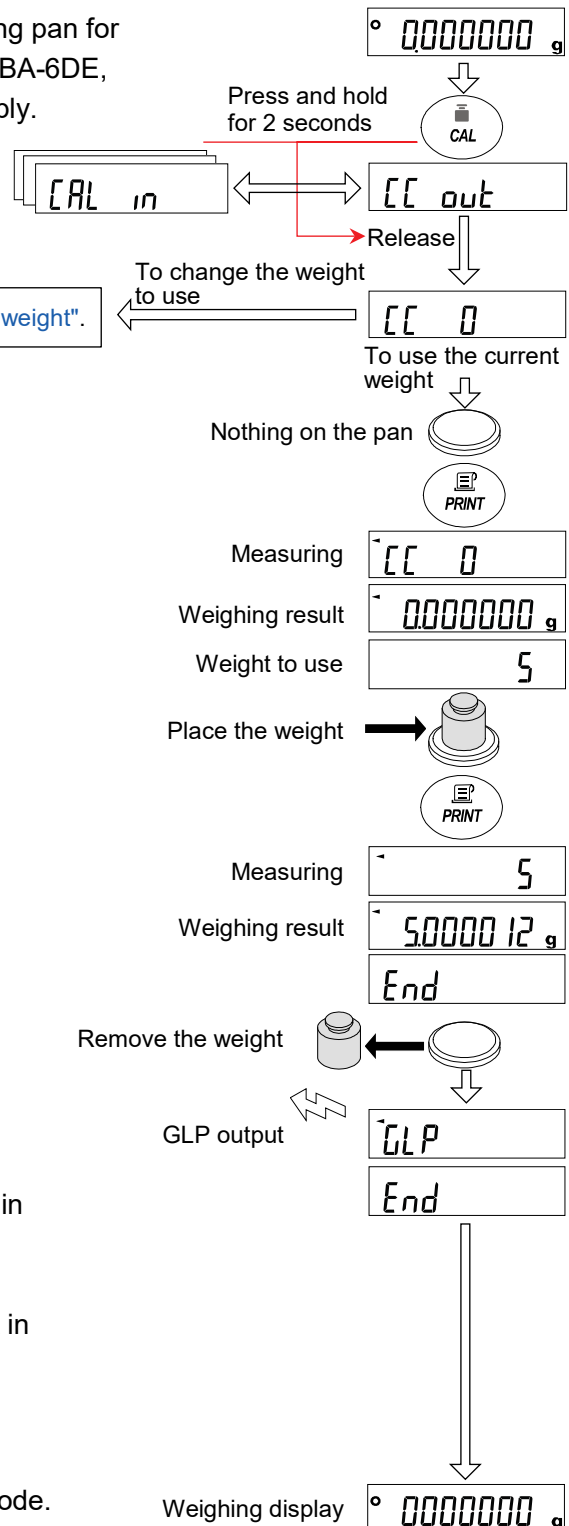

6.6. Setting the value of the weight

For a sensitivity adjustment or calibration test operation, the value of your external weight can be set. (See the usable weight on page 34.) The setting can be made according to the setting procedure after $\boxed{CAL \ 0}$ / $\boxed{CC \ 0}$ is displayed in the procedure of "6.4. Sensitivity adjustment using an external weight" / "6.5. Calibration test using an external weight".

Step 1. With the $\boxed{CAL \ 0}$ display for sensitivity adjustment or $\boxed{CC \ 0}$ display for calibration test, press the \boxed{SAMPLE} key.

Step 2. Using the $\boxed{RE-ZERO}$ key, change the value of the external weight to use while all digits are blinking. (Refer to page 34.)

Step 3. Set the value of the weight with the following keys. \boxed{SAMPLE} key Switches the display between "all digits blinking" (weight selection mode) and "last four digits blinking" (instrumental error adjustment mode).

$\boxed{RE-ZERO}$ key Increases the value of instrumental error. (+)

\boxed{MODE} key Decreases the value of instrumental error. (-)

\boxed{PRINT} key Stores the changed value.

The new value is stored in nonvolatile memory even if the power is removed.

\boxed{CAL} key Suspends the setting.

(The balance returns to the $\boxed{CAL \ 0}$ or $\boxed{CC \ 0}$ display.)

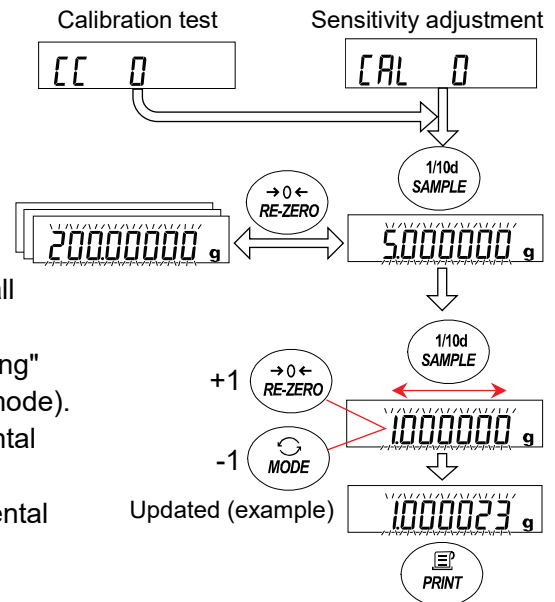

6.7. Correcting the internal weight value

Caution. Correction of the internal weight value cannot be performed at factory setting. Refer to "7. Function Selection Switch and Initialization" or the following setting procedure to enable changes to the function table and correction of the internal weight value.

Setting procedure

Step 1. Press the $\boxed{ON: OFF}$ key to turn the display off.

Step 2. While holding down the \boxed{PRINT} and \boxed{SAMPLE} keys, press the $\boxed{ON: OFF}$ key to display the $\boxed{P5}$.

Step 3. Press the \boxed{PRINT} key. Using the following keys, set the "Internal weight value adjustment switch" and "Function table switch" to $\boxed{1}$.

\boxed{SAMPLE} key Selects the switch (blinking digit).

$\boxed{RE-ZERO}$ key Changes the value of the blinking switch.

Step 4. Press the \boxed{PRINT} key to store the new settings. The balance returns to weighing mode.

Internal weight value adjustment switch ($\boxed{0}$ at factory setting)

Function table switch ($\boxed{1}$ at factory setting)

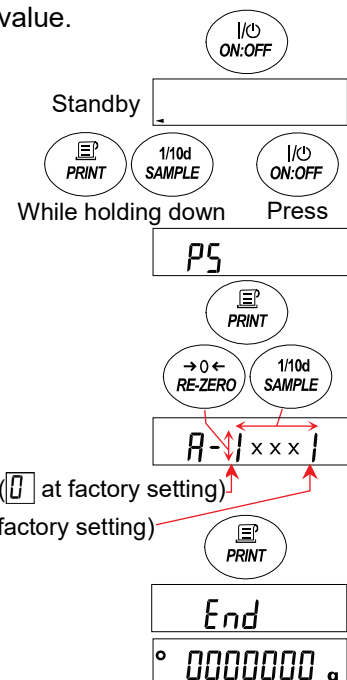

6.7.1. Correcting the internal weight value

This is a method to correct the internal weight value based on your external weight.

First, perform the sensitivity adjustment by referring to "6.4. Sensitivity adjustment using an external weight".

After the sensitivity adjustment with your external weight, the balance automatically loads and unloads the internal weight and corrects the internal weight value. The corrected value is stored in nonvolatile memory even if the AC adapter is removed.

Setting procedure

Correction of the internal weight value cannot be performed at factory setting.

Refer to the setting procedure in "6.7. Correcting the internal weight value" and enable changes to the function table and correction of the internal weight value.

- Step 1. In weighing mode, press and hold the **[SAMPLE]** key for 2 seconds to display **[bASFnC]**.
- Step 2. Press the **[SAMPLE]** key several times until **[CS in]** appears.
- Step 3. Press the **[PRINT]** key to display **[Auto]**.
- Step 4. Make sure there is no external disturbance, then press the **[PRINT]** key. **[CAL. SET]** is displayed and correction of the internal weight value starts automatically.
- Step 5. When the correction of the internal weight value is completed, **[CAL. in]** is displayed and sensitivity adjustment with the corrected internal weight starts automatically.
- Step 6. When the sensitivity adjustment is completed, the next item is displayed.
- Step 7. Press the **[CAL]** key to return to weighing mode.
- Step 8. Place the weight used for correction to confirm that the internal weight value is correctly adjusted. If it is not correctly adjusted, try again from the first step. (Make sure there is no external disturbance during correction of the internal weight value.)

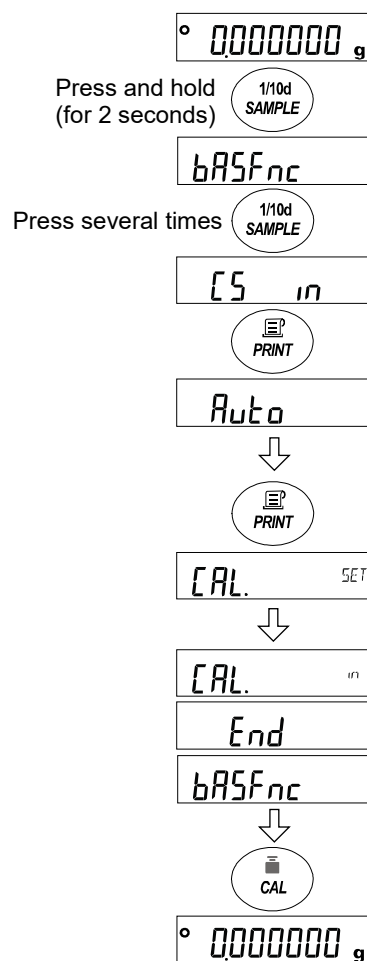

7. Function Selection Switch and Initialization

7.1. Function selection switch

The balance stores data that must not be changed unintentionally (such as adjustment data for accurate weighing, data for adapting to the usage environment, data to control the communications interface, etc.). In order to protect such data, "Function selection switch" is provided and either "prohibit changes" or "allow changes/use" can be selected. When "prohibit changes" is set, inadvertent data change can be prevented because the function cannot be activated.

There are five types of "Function selection switch":

- Function table
- Sensitivity adjustment using the internal weight
- Sensitivity adjustment using an external weight
- Automatic sensitivity adjustment
- Internal weight correction

Setting procedure

- Step 1. Turn off the display.
- Step 2. While holding down the **PRINT** key and the **SAMPLE** key, press the **ON:OFF** key to display **P5**.
- Step 3. Press the **PRINT** key, and then use the following keys to set the function selection switch.

- SAMPLE** keySelects the switch (blinking digit) to change.
 - RE-ZERO** key.....Changes the value of the blinking switch.
 - PRINT** keyStores the new value. The balance returns to weighing mode.
 - CAL** keyCancels the operation (**[Lr]** appears).
- To return to weighing mode, press the **CAL** key again.

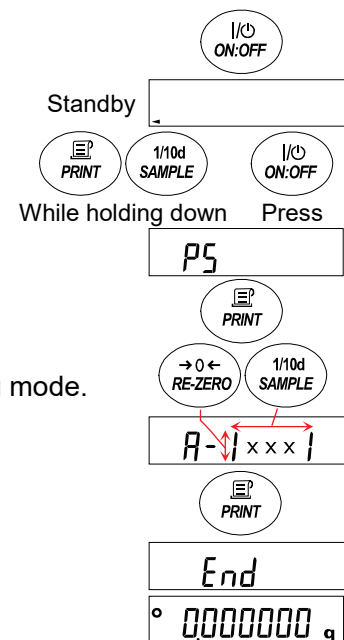

Function selection switch

A-01111

- Function table
 - 0 : Prohibit changes to the function table.
 - 1 : Allow changes to the function table.
- Sensitivity adjustment using the internal weight
 - 0 : Prohibit sensitivity adjustment using the internal weight.
 - 1 : Allow sensitivity adjustment using the internal weight.
- Sensitivity adjustment using an external weight
 - 0 : Prohibit sensitivity adjustment using an external weight.
 - 1 : Allow sensitivity adjustment using an external weight.
- Automatic sensitivity adjustment
 - 0 : Prohibit automatic sensitivity adjustment.
 - 1 : Allow automatic sensitivity adjustment.
- Internal weight value correction
 - 0 : Prohibit internal weight value correction
 - 1 : Allow internal weight value correction

7.2. Initialization

This function returns the parameters of the balance to the factory settings. The data to be initialized are as follows.

- Sensitivity adjustment data
- Function table, unit weight value (counting mode), 100% reference mass value (percent mode)
- Data stored in the balance with the data memory function
- External weight value
- Function switch settings

Caution. After initializing the balance, be sure to perform sensitivity adjustment.

Setting procedure

Step 1. Turn off the display.

Step 2. While holding down the **PRINT** key and the **SAMPLE** key, press the **ON:OFF** key to display **P5**.

Step 3. Press the **SAMPLE** key to display **[Lr]**.

Step 4. Press the **PRINT** key.
(To cancel, press the **CAL** key.)

Step 5. Use the **RE-ZERO** key to switch between **No**/**Go**.

Step 6. With **[Lr]** displayed, pressing the **PRINT** key performs initialization. When initialization is completed, the balance automatically returns to weighing mode.

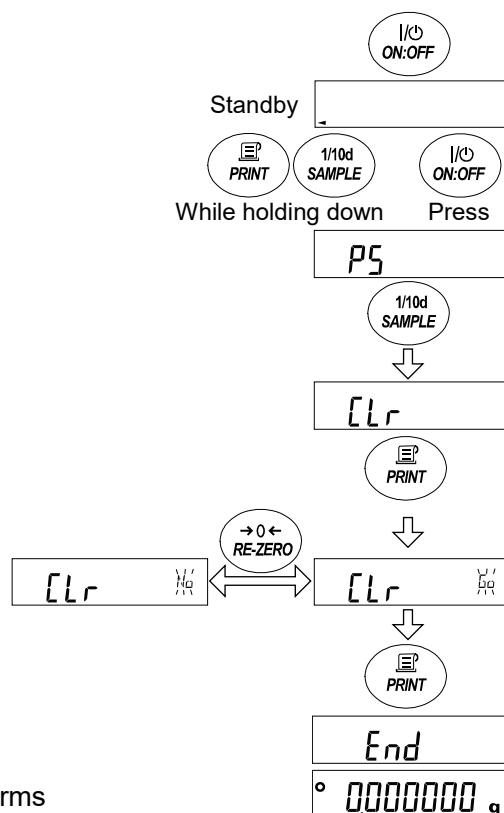

8. Function Table

- The function table enables you to change operation of the balance to the settings suitable for your application. Set parameters are stored in nonvolatile memory, even if the AC adapter is removed, and they are valid until rewritten.
- The function table consists of two layers. The first layer is the classes and the second layer is the items. Each item stores a parameter.

Structure of the function table (Overview)

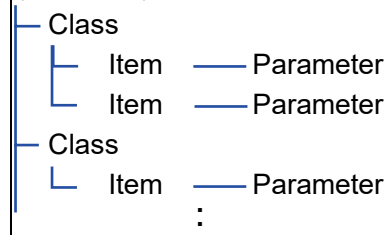

8.1. Setting the function table

Display and key operation for the function table

	The "●" indicator is displayed with the currently enabled parameter.
	In weighing mode, pressing and holding this key for 2 seconds activates class selecting mode of the function table. Selects a class in class selecting mode. Selects an item in item selecting mode.
	Selects a parameter in item selecting mode. Uses the parameter last displayed.
	Selects a class in class selecting mode. Selects an item in item selecting mode.
	In class selecting mode, activates item selecting mode. In item selecting mode, stores the new setting and proceeds to the next class.
	In class selecting mode, quits function table setting and returns to weighing mode. In item selecting mode, cancels the setting and proceeds to the next class.

Setting procedure

- Step 1. In weighing mode, press and hold the **SAMPLE** key for about 2 seconds until **bASFnC**, the first of the classes in the function table, is displayed.

Class

- Step 2. Press the **SAMPLE** key or **MODE** key to select a class.
Press the **PRINT** key to enter the class setting mode.

Item

- Step 3. Press the **SAMPLE** key to select an item.
- Step 4. Press the **RE-ZERO** key to change the parameter.
- Step 5. To make other setting changes in the same class, repeat steps 3 and 4.
To finish setting changes in the class, proceed to step 6.
- Step 6. To store the new setting and proceed to the next class, press the **PRINT** key.
To cancel the new setting and proceed to the next class, press the **CAL** key.

- Step 7. To make other setting changes in a different class, proceed to step 2.
To finish setting, proceed to step 8.

- Step 8. Press the **CAL** key to return to weighing mode.

Setting example

This example shows how to set the parameters for "Data memory" and "Interval time" to "Stores the weighing data and sensitivity adjustment history (`data 2`)" and "1 minute (`int 5`)" respectively.

Activating the function table

- Step 1. In weighing mode, press and hold the `SAMPLE` key for about 2 seconds to display `bRSFnC`.

Weighing display ° `0000000 g`

Press and hold (2 sec.) to activate the function table. 

The first of the classes is displayed. `bRSFnC`

Selecting a class and entering its setting mode

- Step 2. Press the `SAMPLE` key several times to select the class, then press the `PRINT` key.
Class to select: Data output (`dout`)

Press several times to select the class. 

Class desired: Data output `dout`

Enters the class setting mode. 

Selecting an item

- Step 3. Press the `SAMPLE` key several times to select the item.
Item to select: Data memory (`data`)

The first of the items is displayed. `PrT` KEY

Press several times to select the item. 

Item desired: Data memory `data` OFF

Selecting a parameter

- Step 4. Pressing the `RE-ZERO` key twice to select the parameter.
Parameter to select: Stores the weighing data and sensitivity adjustment history (`data 2`)

Press twice to select the parameter. 

Parameter desired: Stores the sensitivity adjustment history `data Wt: CAL`

Selecting the next item and parameter

- Step 5. Press the `SAMPLE` key to display the next item.
Press the `RE-ZERO` key four times to select the parameter.
Parameter to select: Every 1 minute (`int 5`)
To cancel the setting, press the `CAL` key to display the next class.

Proceed to the next item 

Item desired: Interval time `int 2` SEC

Press several times to select the parameter 

Parameter desired: Every 1 minute `int 1` MIN

To cancel 

To store the parameter 

Storing the parameter

- Step 6. To store the parameter, press the `PRINT` key. The next class is displayed.
To make other setting changes in a different class, proceed to step 2.

Next class `5 if`

Finishing setting

- Step 7. To finish setting, press the `CAL` key.
The balance returns to weighing mode.

Finish setting 

Weighing display ° `0000000 g`

8.2. Details of the function table

Class	Item	Parameter	Description	
Environment Display [00]	Condition	0	Fast response, sensitive value	Can also be changed by manual environment setting.
		1	↕	
		2	Slow response, stable value	
	Stability band width	0	Stricter judgment (± 1 d)	If the range in which the weighing display fluctuates for a certain period of time is less than the parameter set, the value is judged to be stable.
		1	↕	
		2	Less strict judgement (± 3 d)	
	Zero tracking	0	Off	Keeps zero display by tracking zero drift.
		1	Normal	
		2	Slightly strong	
		3	Strong	
	Display refresh rate	0	Approx. 5 times/second (5 Hz)	
		1	Approx. 10 times/second (10 Hz)	
	Decimal separator	0	Period (.)	Sets the symbol used as a decimal separator for display and output.
		1	Comma (,)	
	Auto display-ON	0	Disabled	Turns on the weighing mode display when the AC adapter is connected.
1		Enabled		
Auto display-OFF	0	Disabled	Turns off the display after 10 minutes of inactivity.	
	1	Enabled (10 minutes)		
Beep	0	OFF	The buzzer sounds when you operate the keys and the like.	
	1	ON		
Backlight brightness	0 ~ 9	10 % to 100 %		
	5	60% at factory setting		
Clock [01]		Refer to "8.4. Clock and calendar function"	Confirms and sets the time and date. The time and date are added to output data.	

■ Factory setting. "d" is a unit of readability.

The number in [] is the classification number. It is output as an identifier when outputting function table information in batch. Refer to "8.4.1. Batch output of the function table information".

Class	Item	Parameter	Description	
<i>dout</i> Data output [05]	<i>PrL</i> Data output mode	■ 0	Key mode Allows data to be output with the PRINT key when the weighing value is stable.	
		1	Auto print mode A (Reference = zero) Outputs data when the weighing value is stable beyond the range of $\overline{RP-P}$ and $\overline{RP-b}$ from the zero point.	
		2	Auto print mode B (Reference = the latest stable value) Outputs data when the weighing value is stable above the range of $\overline{RP-P}$ and $\overline{RP-b}$ from the latest stable value.	
		3	Stream mode Outputs data at the specified display refresh rate.	
		4	Key mode B (Immediate output) Allows data to be output with the PRINT key regardless of whether or not the weighing value is stable.	
		5	Key mode C (Output when stable) If the weighing value is stable, allows immediate data output with the PRINT key. If the weighing value is not stable, allows data to be output once it has stabilized.	
		6	Interval output mode Outputs data periodically as set for \overline{int} .	
	<i>RP-P</i> Auto print polarity	■ 0	Positive only	If greater than the reference
		1	Negative only	If less than the reference
		2	Bi-polar	Regardless of whether greater or less than the reference.
	<i>RP-b</i> Auto print band width	■ 0	10 d	Select difference from the reference.
		1	100 d	
		2	1000 d	
	<i>dRR</i> Data memory	■ 0	OFF	Refer to "10. Data Memory".
		1	Stores the unit weight.	
		2	Stores the weighing data/sensitivity adjustment history.	
	<i>int</i> Interval time	0	At the specified display refresh rate	Interval time used when "interval output mode (\overline{PrL} 6)" is set in "data output mode".
		■ 1	Every 2 seconds	
		2	Every 5 seconds	
		3	Every 10 seconds	
		4	Every 30 seconds	
5		Every 1 minute		
6		Every 2 minutes		
7		Every 5 minutes		
<i>d-no</i> Data number	■ 0	No output	Available when the data memory function is enabled.	
	1	Outputs data number		

■ Factory setting. "d" is a unit of readability.

The number in [] is the classification number. It is output as an identifier when outputting function table information in batch. Refer to "8.4.1. Batch output of the function table information".

Class	Item	Parameter	Description
dout Data output [05]	5-td Time/date output	0	No output
		1	Outputs the time
		2	Outputs the date
		3	Outputs the time and date
	5-id ID number output	0	No output
		1	Outputs the ID number
	PUSE Data output pause	0	OFF
		1	ON (Adds 1.6 seconds)
	AL-F Auto feed	0	OFF
		1	ON (Adds one line)
	info GLP output	0	OFF
		1	ON (Outputs with the internal clock)
		2	ON (Outputs with an external device clock)
	Ar-d Auto re-zero after data output	0	OFF
		1	ON
	Net Net/gross/tare output	0	OFF (Outputs net weight only)
1		Outputs net and tare weights.	
2		Outputs net and gross weights.	
3		Outputs net, gross, and tare weights.	
5iF Serial interface [06]	bPS Baud rate	0	600 bps
		1	1200 bps
		2	2400 bps
		3	4800 bps
		4	9600 bps
		5	19200 bps
		6	38400 bps
	btPr Data bit, parity bit	0	7 bits, even
		1	7 bits, odd
		2	8 bits, none
CrLF Terminator	0	CR LF	
	1	CR	

■ Factory setting.

The number in [] is the classification number. It is output as an identifier when outputting function table information in batch. Refer to "8.4.1. Batch output of the function table information".

Class	Item	Parameter	Description	
S _{IF} Serial interface [06]	TYPE Data format	■ 0	A&D standard format	Refer to "20. Data Output".
		1	DP format	
		2	KF format	
		3	MT format	
		4	NU format	
		5	NU2 format	
		6	CSV format	
		7	TAB format	
	t-UP Command timeout	0	No limit	The wait time to receive a command.
		■ 1	Limits to one second	
	ErrCd AK, Error code	■ 0	OFF	AK: ASCII 06h code
1		ON		
US _b USB interface [07]	UFnc USB function mode	■ 0	Quick USB	Refer to "Quick USB mode" and "Virtual COM mode".
		1	Bidirectional USB virtual COM	
	U-TP USB data format	■ 0	A&D standard format	Refer to "20. Data Output".
		1	DP format	
		2	KF format	
		3	MT format	
		4	NU format	
		5	NU2 format	
		6	CSV format	
		7	TAB format	
8	UFC format			
MW _{Fnc} Minimum weight alert function [11]	MW-CP Minimum weight comparison	■ 0	No comparison	Disables the minimum weight alert function.
		1	Enables comparison	Excluding near zero.
		2	Enables comparison	Including near zero.
	MW Minimum weight input	Refer to "12. Minimum Weight Alert Function".		
	M _{in out} Data output when minimum weight is not reached.	0	OFF	Refer to "12. Minimum Weight Alert Function".
■ 1		ON		

■ Factory setting.

The number in [] is the classification number. It is output as an identifier when outputting function table information in batch. Refer to "8.4.1. Batch output of the function table information".

Class	Item	Parameter	Description	
<i>Unit</i> Unit [12]			Refer to "4.1. Units".	
<i>id</i> ID number setting [15]			Refer to "9.2. Setting the ID number".	
<i>PASSWORD</i> Password [16]	<i>PW</i> Password function	■ 0	OFF	
		1	ON	
	<i>PASSNo.</i> Password registration	<i>ADMIN</i>	Administrator password input	
		<i>USER 01</i> to <i>USER 10</i>	User 1 password input to User 10 password input	
		<i>P5</i>	Function selection as Administrator	
		<i>n01</i> to <i>n10</i>	Function selection as User 1 to Function selection as User 10	
<i>Auto CAL</i> Automatic sensitivity adjustment [17]	<i>[Fnc]</i> Sensitivity adjustment mode	■ 0	Temperature measurement	
		1	Set time	
		2	Interval time	
	<i>[tME1]</i> Set time 1	Refer to "6.1. Automatic sensitivity adjustment".		
	<i>[tME2]</i> Set time 2			
	<i>[int]</i> Interval time			
<i>[S in]</i> Correction of the internal weight value [18]	<i>Auto</i> (Auto)	Automatic input	Refer to "6.7.1. Correcting the internal weight value".	

■ Factory setting

The number in [] is the classification number. It is output as an identifier when outputting function table information in batch. Refer to "8.4.1. Batch output of the function table information".

Class	Item	Parameter	Description
<i>E</i> × <i>SW</i> External switch [21]	<i>SW1</i> Ex. SW1 function selection	■ 0	<u>RE-ZERO</u> / <u>PRINT</u> key *
		1	Opens/closes the left breeze break door.
		2	Opens/closes the right breeze break door.
	<i>SW2</i> Ex. SW2 function selection	■ 0	<u>RE-ZERO</u> / <u>PRINT</u> key *
		1	Opens/closes the left breeze break door.
		2	Opens/closes the right breeze break door.
<i>IR</i> - <i>S</i> IR sensor [22]	<i>IR</i> IR sensor	0	OFF
		■ 1	ON
	<i>SENSE</i> Sensitivity adjustment	0	High sensitivity
		■ 1	Medium sensitivity
		2	Low sensitivity
	<i>door</i> Door assignment	0	Straight-setting
■ 1		Cross-setting	
<i>R-door</i> Auto doors [23]	<i>OPEN</i> Opening position	0	Partially open
		1	Fully open
		■ 2	Arbitrary position

■ Factory setting

The number in [] is the classification number. It is output as an identifier when outputting function table information in batch. Refer to "8.4.1. Batch output of the function table information".

8.3. Description of the class "Environment/Display"

Condition (Cond)

- $\text{Cond } 0$ Sensitive response to fluctuation of a weighing value
-  For powder or liquid target weighing, weighing a very light sample, or when work efficiency is required rather than display stability, set the parameter to be a small value. When set, **FAST** is displayed.
- $\text{Cond } 2$ Slow response to fluctuation of a weighing value.
- To prevent the weighing value from drifting due to vibration or drafts, set the parameter to be a high value. When set, **SLOW** is displayed.

Stability band width (St-b)

This item is to control the width to regard a weighing value as a stable value. When the fluctuation range of weighing value within a certain period of time is less than the parameter, the balance displays the stabilization indicator and the data can be output (or stored) as set in function table (dout , dRR , etc.).

This setting influences "auto print mode". The readability being displayed is 1 d.

Example. For the BA-6E, if 0.00001 g display is selected with the **SAMPLE** key, 0.00001 g is 1 d.

- $\text{St-b } 0$ The stabilization indicator will not display if the value is not stable enough, and it will disappear if there are even slight fluctuations in the weighing value. To perform weighing with strict judgment, set the parameter to a low value.
- 
- $\text{St-b } 2$ The stabilization indicator becomes less responsive to slight fluctuations in the weighing value. To prevent the weighing value from drifting due to factors such as the usage environment, set the parameter to a high value.

Zero tracking (trc)

This function tracks zero point drift caused by changes in the environment and stabilizes the zero point. The degree of tracking can be selected from three levels.

If zero is not stable, increase the parameter.

When weighing values are only a few "d", do not use the zero tracking. "d" is the smallest unit of display.

	BA-6E/BA-6DE	BA-225/BA-225D/ BA-125D	Description
$\text{trc } 0$	OFF		The tracking function is not used.
$\text{trc } 1$	± 2 d/1 second	± 1 d/1 second	Tracking is normal.
$\text{trc } 2$	± 5 d/0.5 seconds	± 1.5 d/0.5 seconds	Tracking is slightly strong.
$\text{trc } 3$	± 10 d/0.2 seconds	± 1.5 d/0.2 seconds	Tracking is strong.

Display refresh rate (SPd)

The periodic time to refresh the display. This timing also applies to data output.

This parameter influences "baud rate", "data output pause" and the data output rate of "stream mode".

Decimal separator (Pnt)

A symbol used as a decimal separator (point/comma) can be selected.

Auto power ON (P-on)

When the AC adapter is plugged in, the display is automatically turned on without pressing the **ON:OFF** key and the balance enters weighing mode. This function is used when the balance is built into an automated system. Be sure to warm up the balance before use for more than an hour, or more than four hours for the BA-6E/BA-6DE, for accurate weighing.

Auto power OFF (P-off)

This is a function to automatically turn off only the display when there is no operation made for a certain amount of time (approximately 10 minutes) while the power is on.

Buzzer (bEEP)

Select ON/OFF for the built-in buzzer that sounds when a key is operated or the state changes.

Backlight brightness (d, SP-LED)

Select the brightness of the backlight of the LCD display.

8.4. Clock and calendar function

The balance is equipped with a clock and calendar function. When the clock and calendar function (*dout*, *5-td*) is set, the time/date can be added to the output data. The time and date can be checked/changed by the following operations.

Time and date checking/setting procedure

- Step 1. In weighing mode, press and hold the **SAMPLE** key for 2 seconds until **bASFnC** is displayed.
- Step 2. Press the **SAMPLE** key several times to display **CL Adj**.
- Step 3. Press the **PRINT** key. The balance enters the mode to check and set the time and date.

Checking the time

- Step 4. The current time is displayed with all the digits blinking.
- To set the clock to the correct time, press the **RE-ZERO** key and proceed to step 5.
 - To check the date, press the **SAMPLE** key and proceed to step 6.
 - To finish setting, press the **CAL** key and proceed to step 8.

Setting the time

- Step 5. Set the time in 24-hour format using the following keys.
- RE-ZERO** key.....Increases the value of the blinking digit. (+)
 - MODE** key.....Decreases the value of the blinking digit. (-)
 - SAMPLE** key.....Selects the digit to blink.
 - PRINT** key.....Stores the new time setting and proceeds to step 6.
 - CAL** key.....Cancels the new setting and proceeds to step 6.

Checking the date

- Step 6. The current date is displayed with all the digits blinking.
- To change the order of year [last two digits] (y), month (m) and day (d), press the **MODE** key. The date will be output in the specified order.
 - To set the calendar to the correct date, press the **RE-ZERO** key to proceed to step 7.
 - To finish setting, press the **CAL** key to proceed to step 8.
 - To confirm the time again, press the **SAMPLE** key to proceed to step 4.

Setting the date

- Step 7. Set the date using the following keys. (The year is set with the last 2 digits of the year as per Western calendar)
- RE-ZERO** key.....Increases the value of the blinking digit. (+)
 - MODE** key.....Decreases the value of the blinking digit. (-)
 - SAMPLE** key.....Selects the digit to blink.
 - PRINT** key.....Stores the new setting and proceeds to step 8.
 - CAL** key.....Cancels the new setting and proceeds to step 8.

Finishing checking/setting

- Step 8. The next item (*dout*) is displayed. Press the **CAL** key to finish.

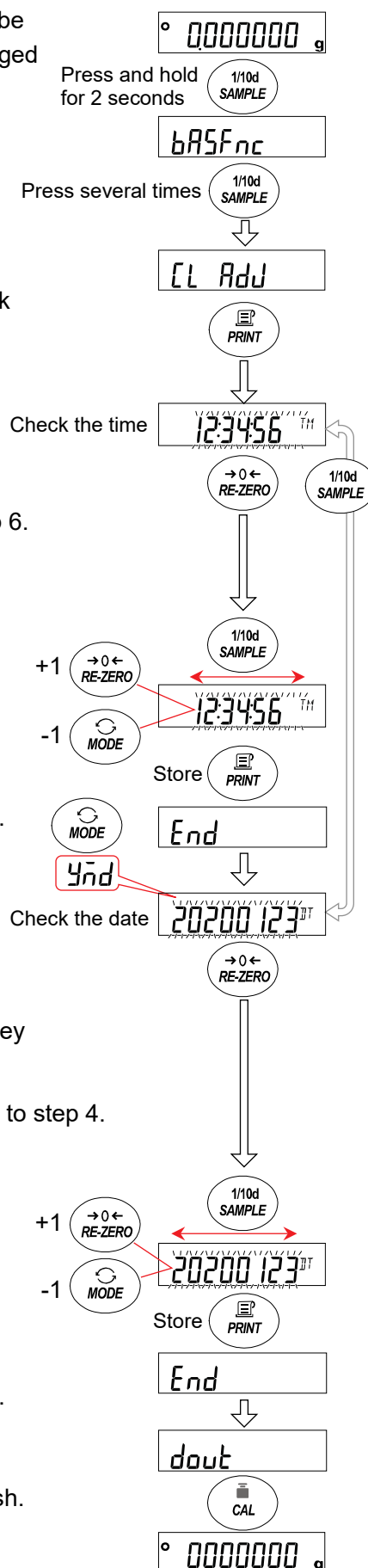

Caution. Do not enter invalid values such as a non-existing date when setting the time and date. The balance displays `rtc PF` when the clock backup battery has been depleted. Battery replacement will be repaired by your local dealer. Even if the backup battery of the clock runs out, it does not affect the functions other than the clock and calendar function. The clock and calendar function works normally if the balance is powered with the AC adapter. Press any key to set the time and date.

8.4.1. Batch output of the function table information

In the function table, you can set the balance's operation to that appropriate for how it is used. In the menu structure of the function table, items are included in each class, and a parameter is stored for each item. The function table information can be output in batch by the following operation so that the settings when the balance is used can be recorded.

- Step 1. Press and hold the `SAMPLE` key for 2 seconds in weighing mode until `bASFnC` is displayed.
- Step 2. Press and hold the `PRINT` key for 2 seconds. `-L,St-` appears and the current function table information is output in batch.

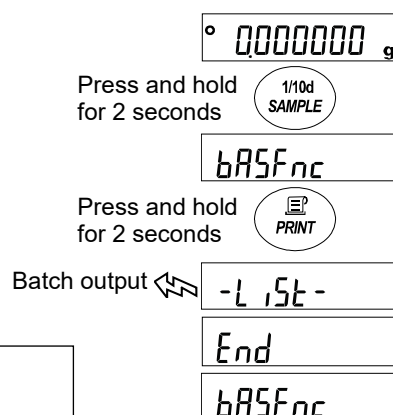

[Output example]

Model	MODEL	A & D
Serial number	S/N	BA-6E
ID	ID	123456789
Clock of the balance	DATE	2020/12/12
	TIME	12:34:56

Function Table

00,	Cond	,01
00,	St-b	,01
00,	trc	,01
00,	Spd	,00
00,	Pnt	,00
00,	P-on	,00
00,	P-off	,00
00,	beep	,01
00,	disp-LED	,50

)

11,	MW-CP	,00
11,	MW	,0.000000
g	11,	Min out ,01

)

21,	Right	,00
21,	Left	,00

)

22,	iR	,01
22,	SNESE	,01
22,	Door	,01

)

23,	OPEN	,02
-----	------	-----

END

(a) Classification number (2 characters)

(b) Item (8 characters)

(c) Parameter (2 or 12 characters)
Separated by commas.
Refer to "8. Function Table" and "8.2. Details of the function table".

Output example 1. Outputting the function table information to a printer

Use an AD-8127 multi-functional compact printer.

- Step 1. Connect the balance and the printer.
Set the print mode to "DUMP". For details about the settings and print modes, refer to the instruction manual of the printer.
- Step 2. Make sure that communication is possible between the balance and the printer, then perform the output operation according to the previous section "Batch output of the function table information".

Output example 2. Outputting the function table information to a personal computer

For USB settings and details of WinCT software, refer to the WinCT manuals on our website (<https://www.aandd.jp>).

- Step 1. Connect the balance and the personal computer with the supplied USB cable or RS-232C cable (sold separately)
- Note. To output via USB, Virtual COM mode must be used. It is not possible to output with Quick USB mode.
- Step 2. Install WinCT software on the personal computer.
WinCT can be downloaded from our website (<https://www.aandd.jp>).
- Step 3. Start RSCom and match the communication settings such as COM port and baud rate with the balance. Clicking the [Start] button enables communication.
- Step 4. Make sure that communication is possible between the balance and the personal computer, then perform the output operation according to the previous section "Batch output of the function table information".

9. GLP Report and ID Number

9.1. Main objectives

The GLP/GMP compliant data can be output to a personal computer or optional printer via the RS-232C serial interface.

The GLP/GMP compliant report includes the balance manufacturer (A&D), model name, serial number, ID number, date, time, and space for signature. For a sensitivity adjustment or calibration test, the result and the weight used are also included.

The balance can output the following GLP/GMP compliant reports via the RS-232C or USB.

- Sensitivity adjustment report
(Output for sensitivity adjustment using the internal weight, automatic sensitivity adjustment, sensitivity adjustment using the external weight)
- Calibration test report
(Output for calibration test using the internal weight or external weight)
- Breaks ("title block" and "end block") for easy management of a series of weighing data
- By changing the function table, sensitivity adjustment results and calibration test results can be temporarily stored in data memory and output in batch.

Note. For details, refer to "10. Data Memory".

- The ID number can be used as an identification number for the balance during maintenance of the balance.
- The ID number is stored in non-volatile memory, even if the AC adapter is removed, and it is valid until a new registration is made.
- For check/adjustment of time/date, refer to "8.4. Clock and calendar function" of "8. Function Table".
- When printing a GLP compliant report with an AD-8127 multi-functional compact printer connected to the balance, the clock function of the printer can be used to print the time and date. (Function table

inF0	2
------	---

). Centralized management using the password lock function on the AD-8127 side is effective in preventing time and date tampering.

Note. To output GLP/GMP compliant reports, set the print mode of the AD-8127 to the dump print mode. If the external key print mode is set for weighing value printing, press and hold the

ENT

 key of the AD-8127 for 2 seconds to switch between the external key print mode and dump print mode.

9.2. Setting the ID number

Step 1. Press and hold the **SAMPLE** key for 2 seconds until **bR5Fnc** is displayed.

Step 2. Press the **SAMPLE** key several times to display **id**.

Step 3. Press the **PRINT** key. Set the ID number using the following keys.

- SAMPLE** key..... Selects the digit to blink.
- RE-ZERO** key, **MODE** key Changes the character of the blinking digit.
- PRINT** key..... Stores the change and displays the next item **PASSword**.
- CAL** key Cancels the change and displays the next item **PASSword**.

Step 4. With **PASSword** displayed, press the **CAL** key to return to weighing mode.

About the display

There are four types of segment displays on the balance display. For each type of segment display, see the correspondence tables below.

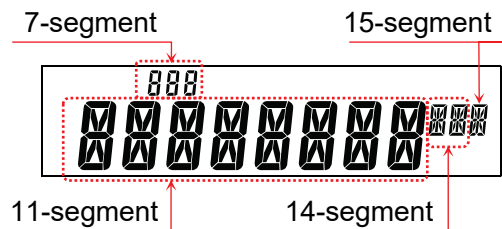

7-segment display

0	1	2	3	4	5	6	7	8	9	-	Space	A	B	C	D	E	F	G
0	1	2	3	4	5	6	7	8	9	-		A	b	C	d	E	F	G
H	I	J	K	L	M	N	O	P	Q	R	S	T	U	V	W	X	Y	Z
H	,	J	L	L	n	n	o	P	q	r	S	t	U	u	v	W	Y	Z

11-segment display

0	1	2	3	4	5	6	7	8	9	-	Space	A	B	C	D	E	F	G
0	1	2	3	4	5	6	7	8	9	-		A	B	C	D	E	F	G
H	I	J	K	L	M	N	O	P	Q	R	S	T	U	V	W	X	Y	Z
H	I	J	K	L	M	N	O	P	Q	R	S	T	U	V	W	X	Y	Z

14-segment display

0	1	2	3	4	5	6	7	8	9	-	Space	A	B	C	D	E	F	G
0	1	2	3	4	5	6	7	8	9	-		A	B	C	D	E	F	G
H	I	J	K	L	M	N	O	P	Q	R	S	T	U	V	W	X	Y	Z
H	I	J	K	L	M	N	O	P	Q	R	S	T	U	V	W	X	Y	Z

15-segment display

0	1	2	3	4	5	6	7	8	9	-	Space	A	B	C	D	E	F	G
0	1	2	3	4	5	6	7	8	9	-		A	B	C	D	E	F	G
H	I	J	K	L	M	N	O	P	Q	R	S	T	U	V	W	X	Y	Z
H	I	J	K	L	M	N	O	P	Q	R	S	T	U	V	W	X	Y	Z

9.3. GLP output

To output GLP/GMP data and the like with an AD-8127 multi-functional compact printer or with a personal computer, set to "INF0 1" (Outputs data with the internal clock of the balance) or "INF0 2" (Outputs with an external device clock) in the function table.

Output examples of sensitivity adjustment with the internal weight

The forms in which GLP data is output when the sensitivity of the balance is adjusted using the internal weight are shown below.

- "Outputs data with the internal clock of the balance" (INF0 1)
Examples in which INF0 1 "Outputs with the internal clock of the balance" of the function table is used to output GLP/GMP data and the like.

Caution

- The internal clock of the balance may need to be adjusted. If necessary, make adjustments in the function table [LL Adj].

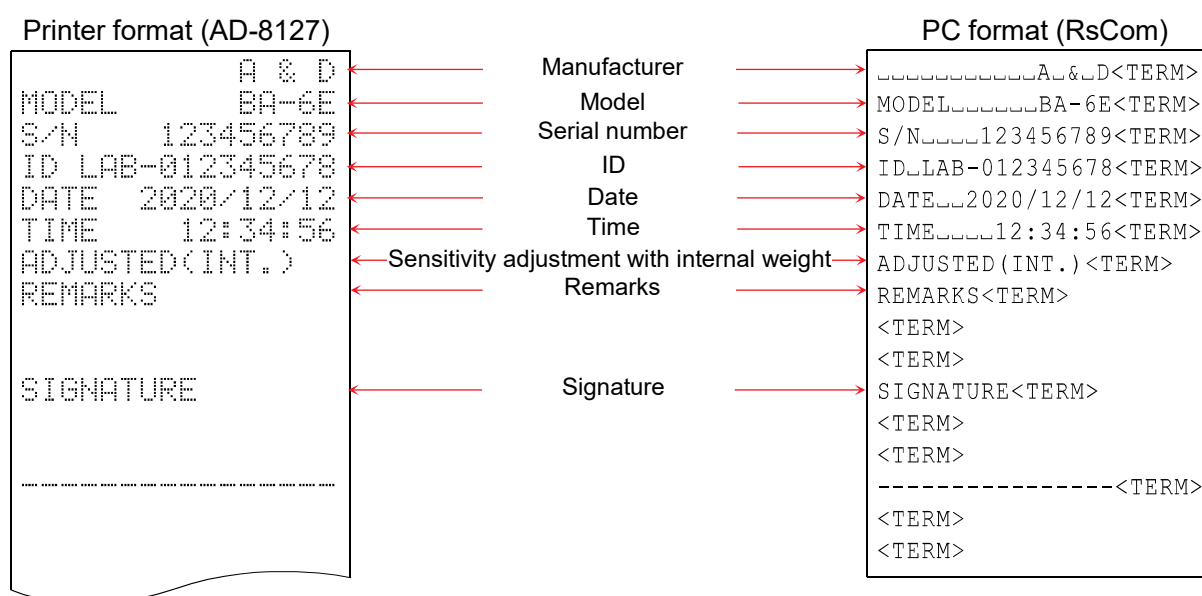

- : Space, ASCII 20h
- <TERM> : Terminator, CR LF or CR
- CR : Carriage return, ASCII 0Dh
- LF : Line feed, ASCII 0Ah

□ “Outputs data with an external device clock” (`INF0 2`)

Examples in which `INF0 2` "Outputs with an external device clock" of the function table is used to output a GLP/GMP report.

When `INF0 2` is set, the clock data from an external device such as a personal computer or printer can be used. This setting is used to unify the clock data with the clock function of the external device.

Caution

- The clock data output from an external device can be used with a device that has a clock function and that can output the date and time in response to `<ESC>D`, `<ESC>T`. (AD-8127 multi-functional compact printer, RsCom [WinCT] data communication software, etc.)
- When storing the sensitivity adjustment history with the data memory function, the internal clock data of the balance is stored even if `INF0 2` is set.

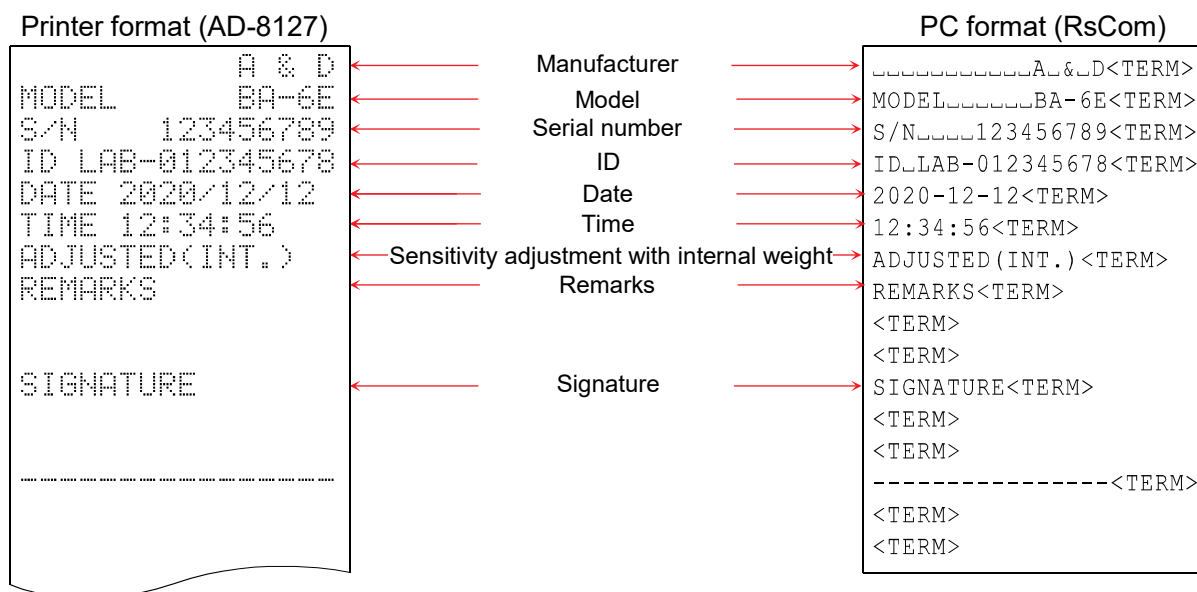

- : Space, ASCII 20h
- <TERM> : Terminator, CR LF or CR
- CR : Carriage return, ASCII 0Dh
- LF : LF Line feed, ASCII 0Ah

Output examples of calibration test with the internal weight

The GLP output forms when the weighing accuracy of the balance is checked using the internal weight are shown below. (Note that sensitivity adjustment is not performed.)

Examples in which `inF0` "Outputs with the internal clock of the balance" of the function table is used.

Printer format (AD-8127)		PC format (RsCom)
MODEL A & D	ManufacturerA&D<TERM>
MODEL BA-6E	Model	MODEL.....BA-6E<TERM>
S/N 123456789	Serial number	S/N.....123456789<TERM>
ID LAB-012345678	ID	ID..LAB-012345678<TERM>
DATE 2020/12/12	Date	DATE..2020/12/12<TERM>
TIME 12:34:56	Time	TIME.....12:34:56<TERM>
CAL.TEST(INT.)	Calibration test	CAL.TEST (INT.) <TERM>
ACTUAL		ACTUAL<TERM>
0.000000 9	Zero point result0.000000...g<TERM>
+4.999999 9	Loaded weight result+4.999999...g<TERM>
TARGET		TARGET<TERM>
+5.000000 9	Target weight used+5.000000...g<TERM>
REMARKS	Remarks	REMARKS<TERM>
		<TERM>
		<TERM>
SIGNATURE	Signature	SIGNATURE<TERM>
		<TERM>
		<TERM>
		-----<TERM>
		<TERM>
		<TERM>

- : Space, ASCII 20h
- <TERM> : Terminator, CR LF or CR
- CR : Carriage return, ASCII 0Dh
- LF : LF Line feed, ASCII 0Ah

Output examples of sensitivity adjustment with an external weight

The GLP output forms when the sensitivity of the balance is adjusted using an external weight are shown below.

Examples in which `inFo I` "Outputs with the internal clock of the balance" of the function table is used.

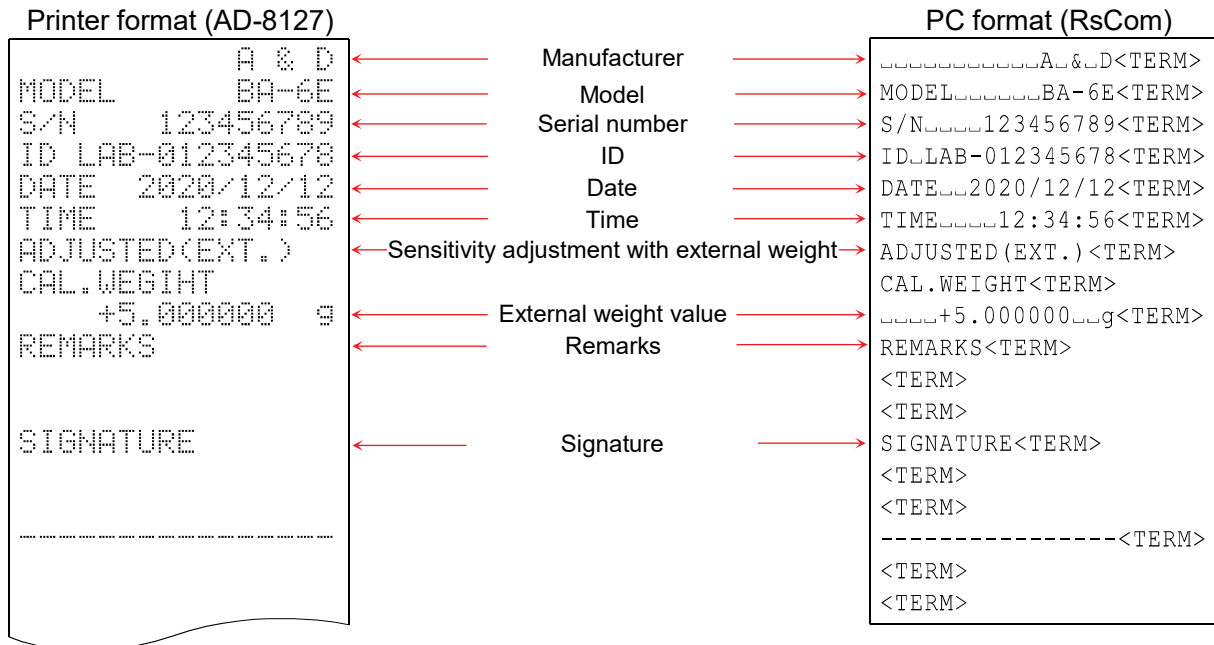

- : Space, ASCII 20h
- <TERM> : Terminator, CR LF or CR
- CR : Carriage return, ASCII 0Dh
- LF : LF Line feed, ASCII 0Ah

Output examples of calibration test with an external weight

The GLP output forms when the weighing accuracy of the balance is checked using the internal weight are shown below. (Note that sensitivity adjustment is not performed.)

Examples in which `inF0` | "Outputs with the internal clock of the balance" of the function table is used.

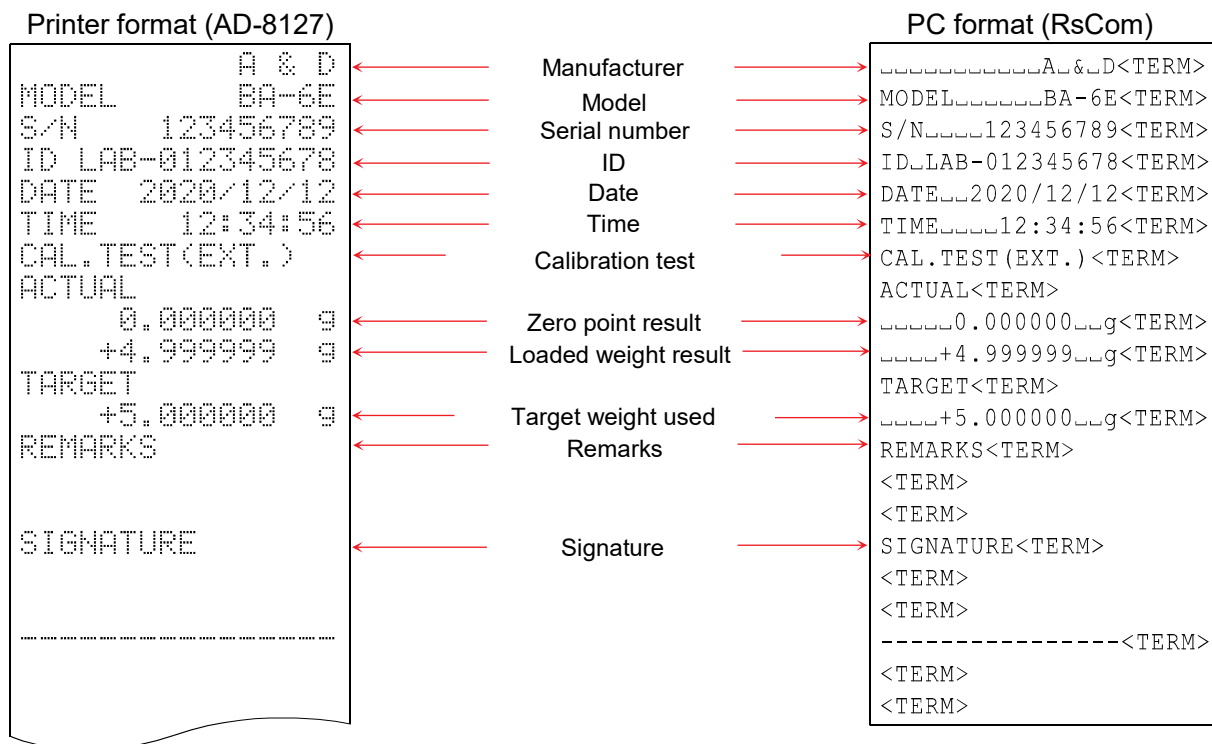

- : Space, ASCII 20h
- <TERM> : Terminator, CR LF or CR
- CR : Carriage return, ASCII 0Dh
- LF : LF Line feed, ASCII 0Ah

Title block and End block

Application/Operation

A "Title block" and "End block" can be added before and after a series of weighing values for data management. Pressing and holding the **PRINT** key for 2 seconds outputs the "Title block" and "End block" alternately.

Caution

- If the data memory function is used, the Title block and End block cannot be output.

Output method using the keys

- Step 1. With the weighing value displayed, press and hold the **PRINT** key for 2 seconds until **Start** is displayed to output the "Title block".
- Step 2. Output the weighing value. The output method depends on the setting of the data output mode.
- Step 3. Press and hold the **PRINT** key for 2 seconds until **End** is displayed to output the "End block".

Examples in which **TYPE 1** "DP format" of the function table is used.

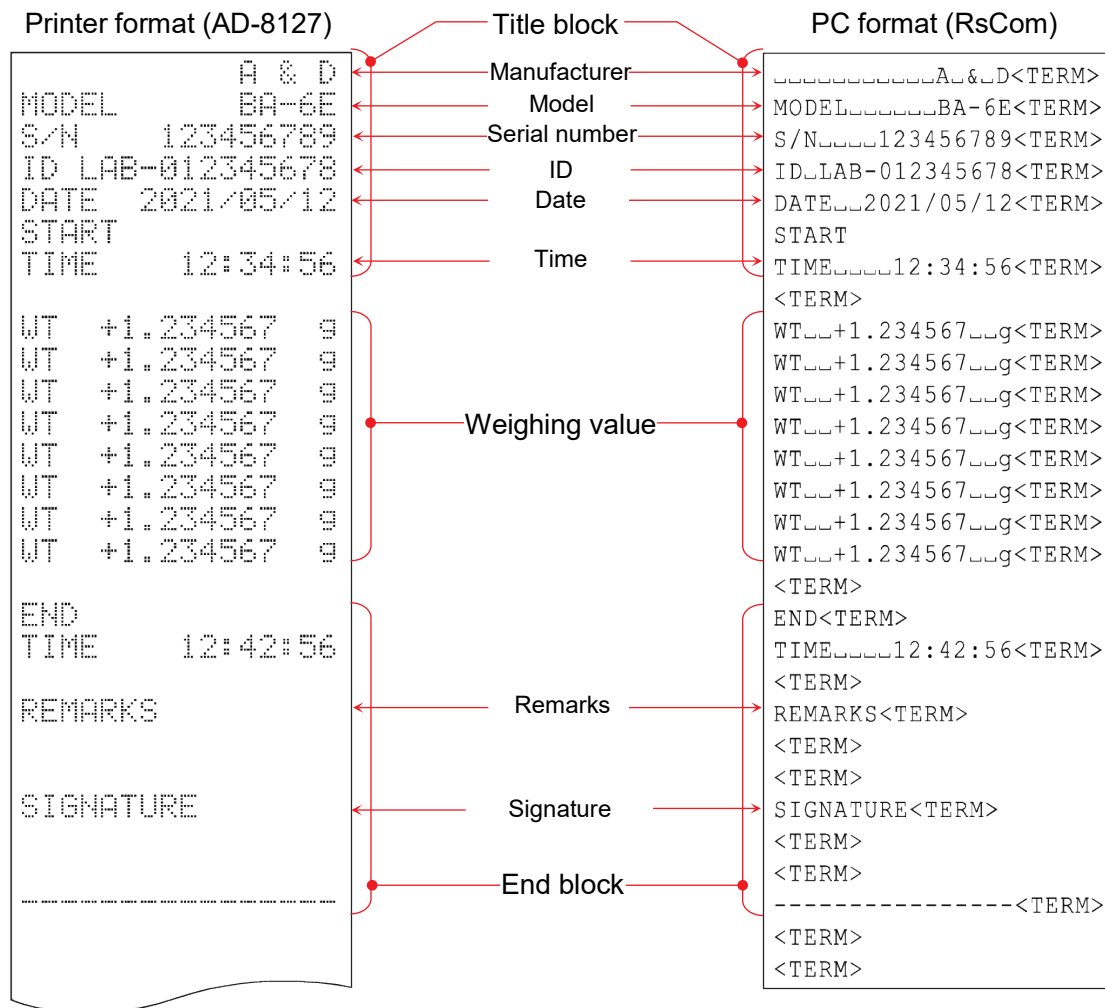

□ : Space, ASCII 20h

<TERM> : Terminator, CR LF or CR

CR : Carriage return, ASCII 0Dh

LF : LF Line feed, ASCII 0Ah

10. Data Memory

- Data memory is a function to store in the balance unit weights for counting mode, weighing results, sensitivity adjustment results, etc., and afterward to perform data confirmation or batch output. The following six types of data can be stored.

1	Unit weight (counting mode)	Up to 50 weights
2	Weighing value	Up to 200 values
Sensitivity adjustment history		Up to 50 results
3	Sensitivity adjustment report with the internal weight	
4	Calibration test report with the internal weight	
5	Sensitivity adjustment report with an external weight	
6	Calibration test report with an external weight	

Caution

- When "Net/Gross/Tare output (Net)" of the function table is set to other than "Off (Net 0)", the data memory function cannot be used to store/output weighing values.

10.1. Data memory for weighing data

Features

Weighing results can be stored in the internal memory of the balance.

The balance can store weighing results so that you can continue weighing work without a printer or a personal computer connected.

- The balance can store weighing results so that you can perform weighing work without occupying a printer or personal computer for a long time.
- Stored data can be displayed on the balance as needed for confirmation.
- Stored data can be output in batch (to an optional printer or personal computer). The output format and whether to add a data number, time/date, and ID number can be selected with the function table.
- The balance has a capacity to store up to 200 weighing results with timestamp.

Note. For how to store unit weights, refer to "4.4. Counting mode (PCS)".

Storing the weighing results

Step 1. Set the "Data memory (dRtR)" of the function table to "Stores weighing data and sensitivity adjustment history (dRtR 2)". Refer to "8. Function Table" and also the following section "Enabling data memory function".

Step 2. In the item "Time/Date output (5-td)" of the function table, set whether to add timestamp.

Step 3. The method for storing the weighing results depends on the operation of "Data output mode (Pnt)" of the function table.

Caution. When "stream mode (Pnt 3)" is set, data may not be stored correctly.

Note. The time and date settings can be changed after the weighing values are stored.

Enabling data memory function

Step 1. Press and hold the **SAMPLE** key for 2 seconds until **bRSFnc** is displayed.

Step 2. Press the **SAMPLE** key several times to display **dout**.

Step 3. Press the **PRINT** key.

Step 4. Press the **SAMPLE** key several times to display **dAtA**.

Step 5. Press the **RE-ZERO** key to display **dAtA Wt / CR**.

Step 6. Press the **PRINT** key to store the setting.

Step 7. Press the **CAL** key to return to weighing mode.

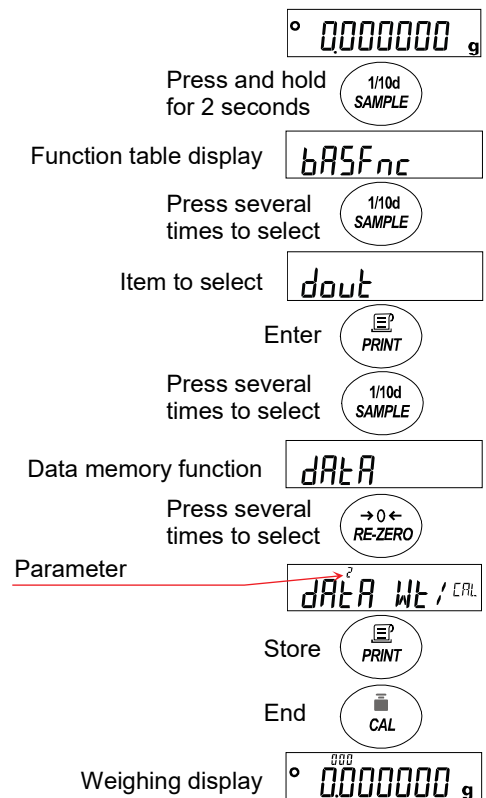

Display and indicator

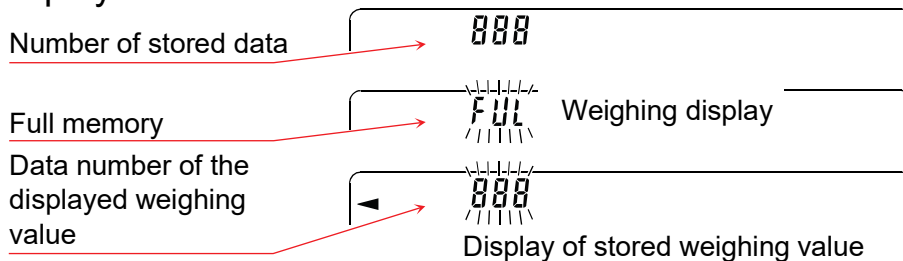

When the volume of stored values reaches the maximum capacity, **FULL** and **dAtA** blink in turn.

Caution

- When weighing data is being stored in memory, the data is output simultaneously via RS-232C or USB interface.
- **FULL** indicates that the memory capacity has been reached. More data cannot be stored unless the stored data is deleted.
- When the interval output mode is running, the balance does not perform automatic sensitivity adjustment due to temperature change.
- Weighing data cannot be stored while the net/gross/tare function is being used.

Setting the function table

Combination of the items by operation mode

Mode \ Item	Data output mode	Auto print Polarity and width	Data memory function	Interval output time
Key mode	<i>Pr</i> t 0	N/A	<i>dAtA</i> 2	N/A
Auto print mode A	<i>Pr</i> t 1	<i>AP-A</i> 0 ~ <i>AP-A</i> 2		
Auto print mode B	<i>Pr</i> t 2	<i>AP-b</i> 0 ~ <i>AP-b</i> 2		
Key mode B (Immediate output)	<i>Pr</i> t 4	N/A		
Key mode C (Output when stable)	<i>Pr</i> t 5			
Interval output mode	<i>Pr</i> t 6			

Output selection for data number, ID number, and time/date

Data number	No output	<i>d-no</i> 0	Up to 200 data can be stored.
	Output	<i>d-no</i> 1	
ID number	No output	<i>S-id</i> 0	
	Output	<i>S-id</i> 1	
Time/date	No output	<i>S-td</i> 0	
	Time output only	<i>S-td</i> 1	
	Date output only	<i>S-td</i> 2	
	Time and date output	<i>S-td</i> 3	

Displaying the stored weighing result

Caution. Confirm that the "Data memory (*dAtA*)" of the function table is set to "Stores the weighing data and sensitivity adjustment history (*dAtA* 2)".

Step 1. Press and hold the **PRINT** key for 2 seconds until **RECALL** is displayed. "-d-" or "d-t" is displayed at the top left of the display .

Left of the display

-d-

Without time/date setting
or

d-t

With time/date setting

Step 2. Press the **PRINT** key to enter the memory recall mode.

Operate the following keys.

RE-ZERO key.....Displays the next data set.

MODE key.....Displays the previous data set.

PRINT key.....Outputs the displayed data via RS-232C or USB.

CAL key.....Exits the memory recall mode.

Step 3. Press the **CAL** key to return to weighing mode.

Note. The time and date output settings can be changed after the weighing values are stored.

Outputting the stored weighing results in batch

Caution. In order to output in batch, "Serial interface (S iF)" or "USB interface (U5b)" of the function table must be configured. Refer to "8. Function Table".

Step 1. Press and hold the **PRINT** key for 2 seconds until **RECALL** is displayed.

Step 2. Press the **SAMPLE** key several times to display **out**, then press the **PRINT** key.

Step 3. Press the **RE-ZERO** key to display **out** .

Step 4. Press the **PRINT** key to output the stored data in batch via RS-232C/USB.

Step 5. The balance displays **CLEAR** when the output is completed.
Press the **CAL** key to return to weighing mode.

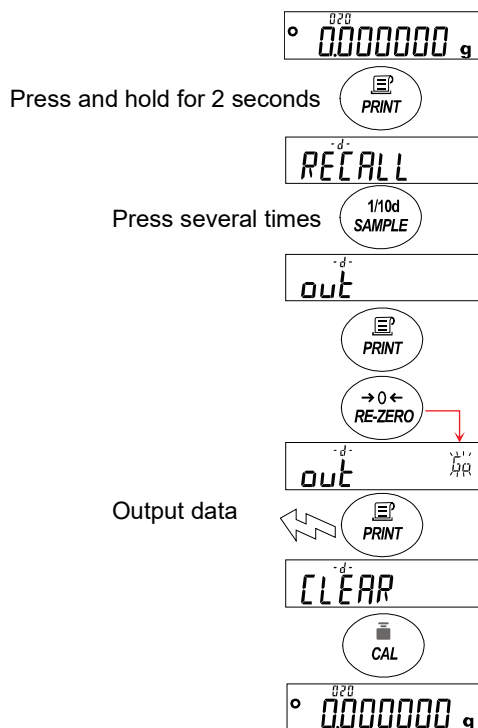

Deleting the stored weighing results in batch

Step 1. Press and hold the **PRINT** key for 2 seconds until **RECALL** is displayed.

Step 2. Press the **SAMPLE** key several times to display **CLEAR**, then press the **PRINT** key.

Step 3. Press the **RE-ZERO** key to display **CLEAR** .

Step 4. Press the **PRINT** key to delete all the stored data.

Step 5. The balance displays **End** when the deletion is completed, then returns to weighing mode.

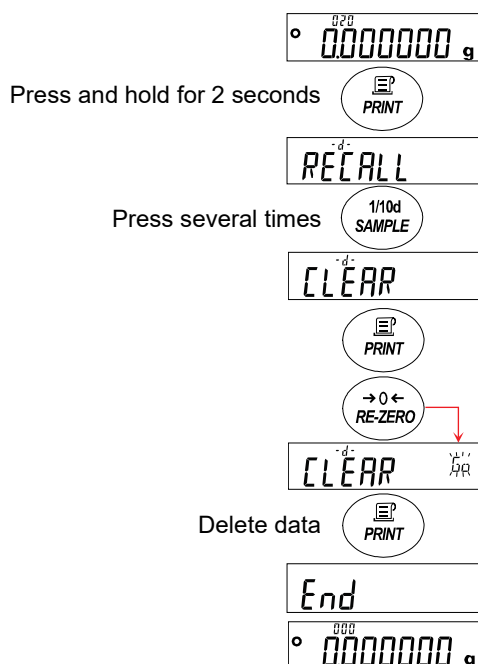

10.2. Data memory for sensitivity adjustment and calibration test

Features

- The histories of sensitivity adjustment (with the internal weight/with an external weight) and the results of calibration test can be stored in the internal memory of the balance.
- The stored results can be output in batch (to an optional printer or a personal computer).
- The balance can store the results of the last 50 sensitivity adjustments/calibration tests.

Note. When the number of results exceeds 50, the \overline{FUL} and \overline{CAL} displays will blink alternately.

Storing the data

Step 1. Set "Data memory (dAtA)" to "Stores weighing data and sensitivity adjustment history (dAtA 2)". Refer to "8. Function Table".

Step 2. With this setting, data is automatically stored when normal sensitivity adjustment or calibration test is performed.

Outputting the sensitivity adjustment history

Step 1. In weighing mode, press and hold the \overline{CAL} key for 2 seconds. When $\overline{CAL H 15}$ is displayed, release your finger from the key. \overline{out} appears. If there is no sensitivity adjustment history, $\overline{No dAtA}$ is displayed, then the balance returns to weighing mode.

No sensitivity adjustment history

Weighing display

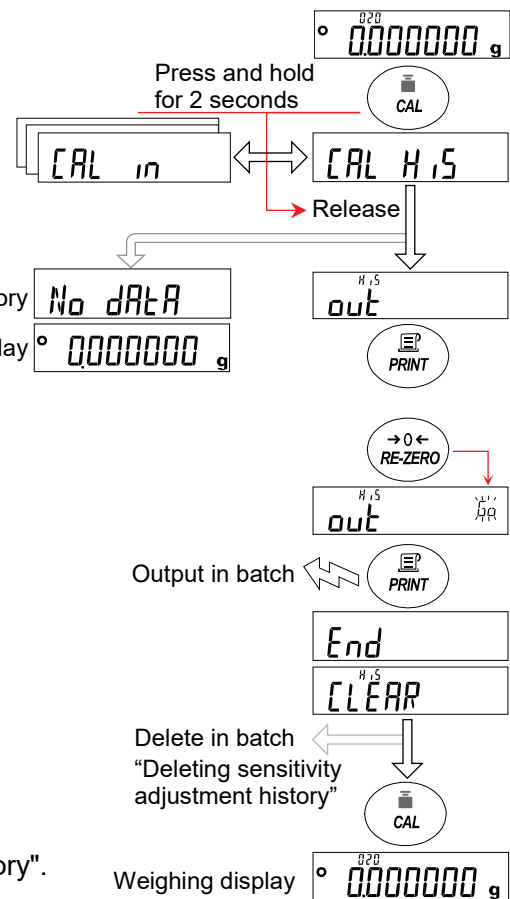

Step 2. With \overline{out} displayed, press the \overline{PRINT} key.

Step 3. Press the $\overline{RE-ZERO}$ key to display \overline{out} $\overline{H 15}$ \overline{RR} .

Step 4. Press the \overline{PRINT} key to start batch outputting. The output format is compliant with "GLP output".

Step 5. When output is completed, \overline{End} and then \overline{CLEAR} will appear.

Step 6. To delete saved histories in batch, proceed to the following section "Deleting sensitivity adjustment history". To return to weighing mode, press the \overline{CAL} key.

Note. If the \overline{FUL} \leftrightarrow \overline{CAL} displays are blinking alternately in weighing mode, the memory capacity of 50 sets of data has been reached. If a new result is saved in this state, the oldest data will be overwritten. Delete some of the data stored in memory.

Deleting the sensitivity adjustment history

- Step 1. Press and hold the **CAL** key for 2 seconds.
 When **CAL H, S** is displayed, release the key.
out appears.
 If no history is stored, **No dAtA** appears and the balance returns to weighing mode.
- Step 2. With **out** displayed, press the **SAMPLE** key to display **CLEAR**.
- Step 3. Press the **PRINT** key, then the **RE-ZERO** key to display **CLEAR**.
- Step 4. Press the **RPINT** key to start batch deletion.
- Step 5. When deletion is completed, the balance displays **End** and returns to weighing mode.

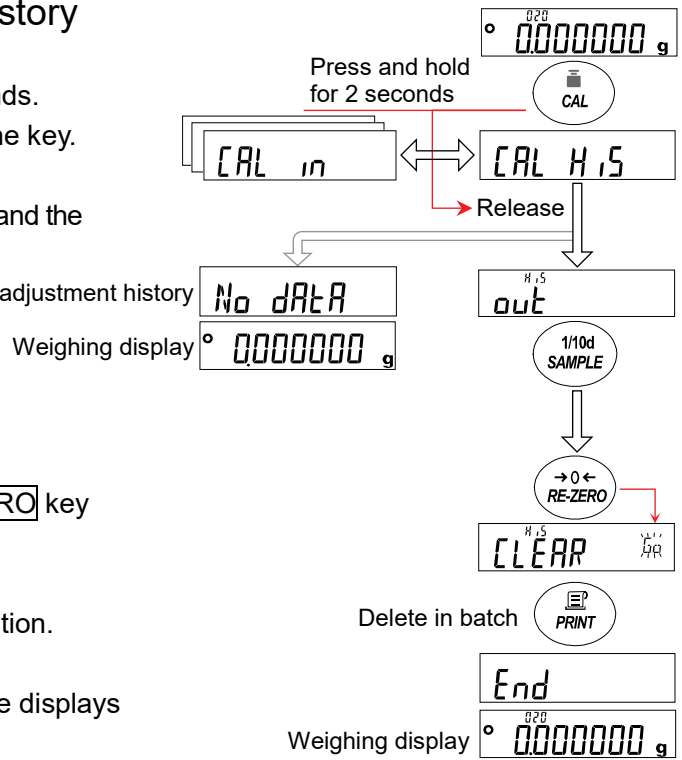

10.3. Data memory for “unit weight” in the counting mode

Features

- Up to 50 unit weights can be stored for “unit weight” in the counting mode.
P01 is the first unit weight data, and it is the standard memory in normal counting mode. 49 additional unit weights can be stored.
- The stored unit weight is stored in nonvolatile memory even if the power is removed.
- By reading the stored unit weight, the counting operation can be performed without registering the unit weight each time.
- The read unit weight can be changed in "Load registration mode" (method of registering the unit weight by placing a specified number of samples) or "Digital registration mode" (method of inputting the unit weight digitally).

10.3.1. Registering unit weight data

When registering (storing) a new unit weight, read the unit weight data to be changed, change it in "load registration mode" or "digital registration mode", and register (store) it. The unit weight data can be registered (changed) in a range from *P01* to *P50*.

Step 1. Set “Data memory (*dAtA*)” of the function table to “Stores the unit weight (*dAtA* 1)”. Refer to “8. Function Table”.

Step 2. Press the **MODE** key to select the unit *P05* (counting mode).

Caution If it is not displayed, register *P05* in the unit registration of the function table.

Step 3. Press the **PRINT** key for 2 seconds to enter confirmation mode.

The unit weight data (the unit weight number and blinking display of unit weight value) is read.
The latest unit weight data selected or registered is displayed.

Step 4. Use the following keys to select the unit weight number to use.

RE-ZERO key.....Increases the unit weight number by one.

MODE keyDecreases the unit weight number by one.

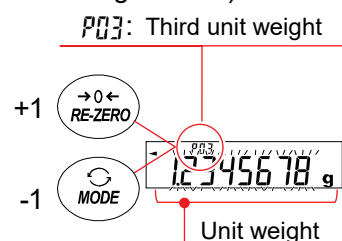

Changing (registering) the selected (read) unit weight data

Step 5. Select the changing (registering) method.

- To change by load registration, press the **SAMPLE** key to proceed to "Load registration mode".
- To change by digital registration, press the **SAMPLE** key and hold down the **MODE** key to proceed to "Digital registration mode".

Caution. ACAI cannot be applied to the read unit weight.

Note

- The unit weight can be read with the “UN:nn” command. (nn: 01 to 50)
- The read unit weight can be output with the “?UW” command and changed with the “UW:” command.
- For description about the “UN:nn” and “?UW” commands, refer to "21.1. Control commands". (nn: 01 to 50)

Load registration mode

Step 6. Load registration mode is a mode in which the specified number of samples are placed on the weighing pan and the unit weight is registered.

In load registration mode, you can use ACAI after registering the unit weight. Refer to "4.4. Counting mode (PCS)". Register the actual weight using the following keys.

SAMPLE keyChanges the number of samples used for registration.

10 0 PCS → 25 0 PCS → ...

RE-ZERO key.....Sets the display to zero.

10 - PCS → 10 0 PCS

PRINT keyPressing the **PRINT** key when the samples are placed registers (stores) the unit weight in data memory, then returns to the same state as step 3. For details on how to register the unit weight, refer to "4.4. Counting mode (PCS)".

CAL keyReturns to the same state as step 3 in "10.3.1. Registering unit weight data".

MODE keyTo enter "digital registration mode", press the **MODE** key for 2 seconds.

Digital registration mode

Step 6. Digital registration mode is a mode in which the unit weight of a sample is input digitally (as a numerical value) when the unit weight of the sample (weight of one sample) is known in advance. In digital registration mode, the digit to change blinks.

Caution In digital registration mode, ACAI cannot to be applied after registering the unit weight. Refer to "4.4. Counting mode (PCS)".

Perform digital registration using the following keys.

SAMPLE key Changes the setting digit.

RE-ZERO key..... Changes the setting value.

MODE key Changes the position of the decimal separator.

PRINT key Registers (stores) the unit weight in data memory and then returns to the same state as step 3.

CAL key Returns to the same state as step 3 in "10.3.1. Registering unit weight data".

MODE key To enter "load registration mode", press the **MODE** key for 2 seconds.

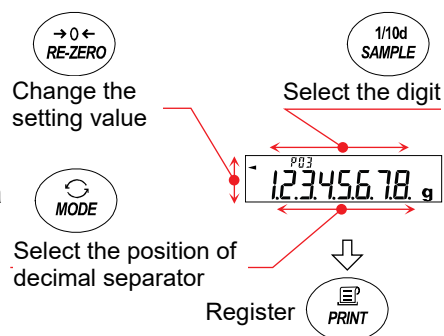

10.3.2. Reading the unit weight data

Step 1. Follow the steps 1, 2 and 3 of "10.3.1. Registering unit weight data" to enter the confirmation mode.

Step 2. Select the unit weight number to use with the following keys.

RE-ZERO key..... Increases the unit weight number by one.

MODE keyDecreases the unit weight number by one.

Step 3. Press the **PRINT** key to set the unit weight to use. The balance returns to weighing mode (count display).

To return to the weighing mode (count display) without changing the unit weight, press the **CAL** key.

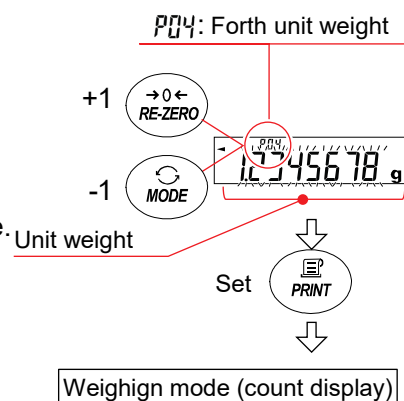

Caution. If the set value is less than the setting range, **Error 2** is displayed.

11. Gross/Net/Tare Function

- Zero setting and tare operation can be performed separately. Gross weight, net weight, and tare weight data can be output. In order to use the gross/net/tare function, it is necessary to change the function table.

Caution

- When "Net/Gross/Tare output (NGT)" is set to other than "NGT 0" in the function table, the data memory function cannot be used to store/output the weighing value.

Function table (excerpt)

Class	Item	Parameter	Description
dout Data output	NGT Net/gross/tare output	0	Off (Outputs net weight only)
		1	Outputs net and tare weights.
		2	Outputs net and gross weights.
		3	Outputs net, gross, and tare weights.

11.1. Preparations for gross/net/tare function

Setting procedure

- To use the gross/net/tare function, it is necessary to set "Net/gross/tare output (NGT)" of "Data output (dout)" to "Outputs net and tare weights (NGT 1)", "Outputs net and gross weights (NGT 2)", or "Outputs net, gross, and tare weights (NGT 3)" in the function table. To return to the normal weighing mode (factory setting), set "Net/gross/tare output (NGT)" to "NGT 0". To set the function, follow the procedure below.

Step 1. Press and hold the **SAMPLE** key for 2 seconds until **bRSFnc** is displayed.

Step 2. Press the **SAMPLE** key several times to display **dout**.

Step 3. Press the **PRINT** key, then the **SAMPLE** key several times to display **°NGT 0FF**.

Step 4. Press the **RE-ZERO** key several times to display **NGT NET**.

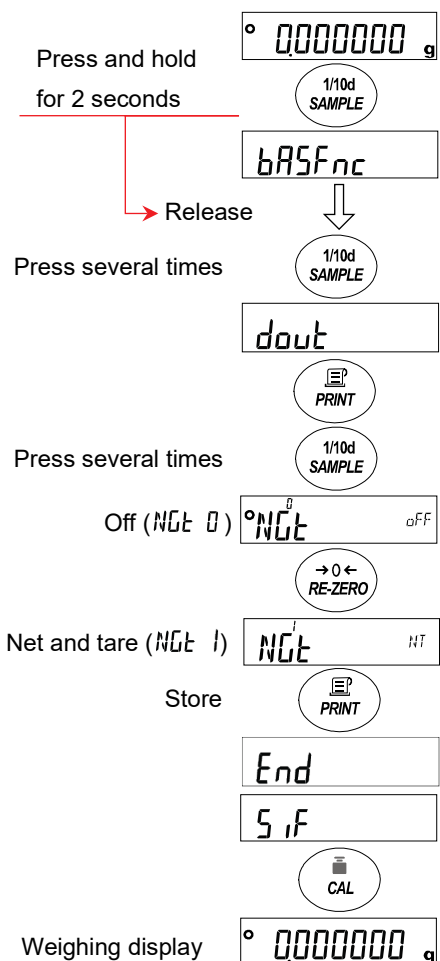

Step 5. Press the **PRINT** key to store the setting.

Step 6. Press the **CAL** key to return to weighing mode.



Key operation

- Key operations for the weighing value (gross) are as follows.

Key	Function	Weighing value (gross)	Operation
	Zero setting (ZERO) or Tare (TARE)	Within the zero range *1	Updates the zero point and clears the tare value.
		Exceeding the zero range *1	Performs tare operation and updates the tare value.
		Negative value	Updates the zero point and clears the tare value.
	Tare (TARE)	Positive value	Performs tare operation and updates the tare value.
		Gross zero (Gross zero indicator lights) *2	Clears the tare value.
		Negative value	Displays <code>PRESS ZERO</code> for 2 seconds. (Does not clear the tare value.) Press <code>RE-ZERO</code> key.

*1 "Zero range" means the range where the load is within $\pm 2\%$ from the reference zero to the weighing capacity. For the zero range of each model, refer to "4.2. Basic operation".

*2 "Gross zero" means that the gross weight minimum division is in the range of zero when the unit is "g". (The state in which the gross zero indicator is lit.)

Display

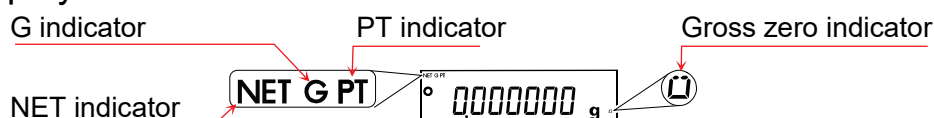

Indicator	Description
NET	Lights when the tare value is other than zero.
G	Lights when the tare value is zero.
PT	Lights with the NET indicator when the preset tare is set by the PT command.
Gross zero	"□" lights when the minimum division of the gross is in the zero range in grams.

Output

- Each time the `PRINT` key is pressed, the data is output as set in "NET" of the function table.

Function table	Output data
NET 0	Net weight only
NET 1	Net weight, tare weight
NET 2	Net weight, gross weight
NET 3	Net weight, gross weight, tare weight

- The supported output formats are as follows.

If you select an output format that is not supported, the output will be in the A&D standard format.

Supported formats	A&D standard format, DP format, CSV format, TAB format
-------------------	--

Output example (A&D standard format)

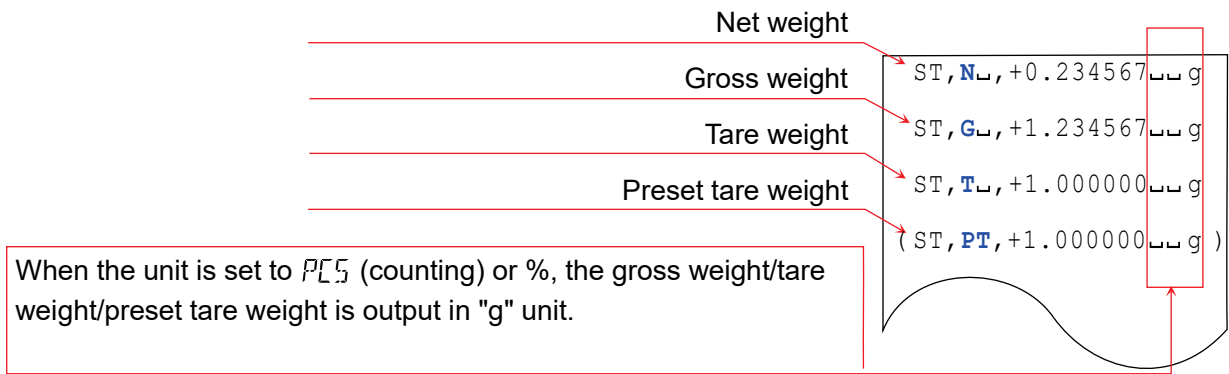

- The output content and order can be set using the UFC function. For details, refer to “23. UFC Function”.

11.2. Using the gross/net/tare function (example)

Step 1. After the gross/net/tare function is set, press the **RE-ZERO** key with nothing on the weighing pan. The “G” indicator is displayed.

Step 2. Place an empty container to be used on the weighing pan.

Step 3. Press the **TARE** key to display **NET 0000000 g**. The tare value is set (updated). The "NET" indicator is displayed.

Step 4. Place the sample to be weighed.

Step 5. Press the **PRINT** key to output the data as set in “NET” of the function table.

Step 6. Remove everything on the weighing pan, and press the **RE-ZERO** key to update the zero point and clear the tare weight. The balance returns to the same state as Step 1.

To continue weighing with the same tare value, remove only the sample and place the next sample, and then press the **PRINT** key to output the data.

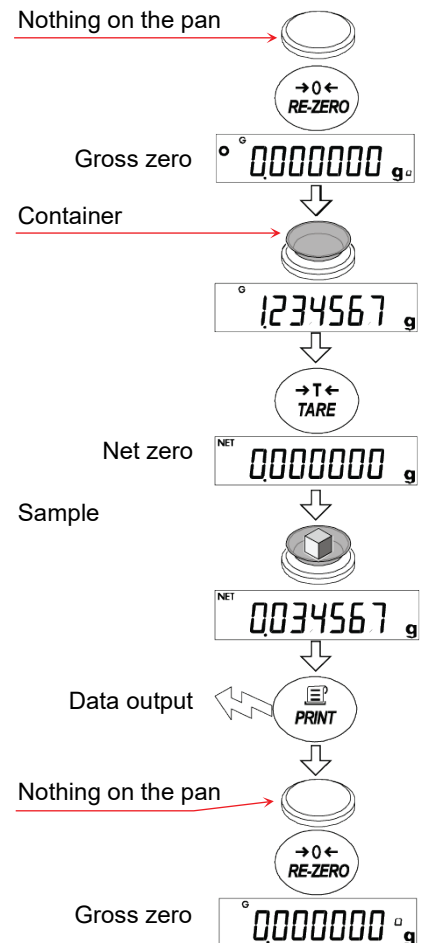

12. Minimum Weight Alert Function

- Minimum weight is the minimum sample weight required to perform correct quantitative analysis taking the measurement error of the balance used into account. If the sample amount is too small, the proportion of measurement error in the measured value increases, and the reliability of the analysis result thus may drop.
- The minimum weight alert function makes it possible to judge immediately whether the sample amount meets the set minimum weight.
With this function, "M" displays blinking at the top of the unit when the sample amount is less than the set minimum weight. When the sample amount exceeds the set minimum weight, "M" is hidden.
- This function can be used only in "mg" unit mode.
- The minimum weight can be changed in the function table. The factory setting is 0 mg. When the set value is 0 mg, even if the "Minimum weight alert function (MW-CP)" of the function table is set to "Enables comparison excluding near zero (MW-CP E:0)" or "Enables comparison including near zero (MW-CP IN0)", the alert is not displayed. Values above the weighing capacity cannot be set as a minimum weight.
- There are two types of alert displays: Near zero is within ± 10 d of 0 mg.
"Enables comparison excluding near zero (MW-CP E:0)"
"Enables comparison including near zero (MW-CP IN0)"

Caution

- When a parameter other than "Disables minimum weight alert function (MW-CP OFF)" is set, the **MODE** key is assigned to the minimum weight setting and the unit cannot be changed with the **MODE** key. (The unit is fixed to mg.)
- To change the unit, disable the minimum weight alert function.
- To disable the minimum weight alert function, refer to the procedure in "12.1. Enabling the minimum weight comparison" and set to MW-CP OFF.

12.1. Enabling the minimum weight comparison

Setting procedure

- Step 1. Press and hold the **SAMPLE** key for 2 seconds until **bRSFnC** is displayed.
- Step 2. Press the **SAMPLE** key several times to display **MW Fnc**.
- Step 3. Press the **PRINT** key.
- Step 4. With **MW-CP** displayed, press the **RE-ZERO** key to switch the display from **MW-CP OFF** to **MW-CP EX0** (excluding near zero) or **MW-CP IN0** (including near zero).
- Step 5. To change the minimum weight setting, proceed to step 6. To return to weighing mode without changing the minimum weight, press the **CAL** key.
- Step 6. Press the **SAMPLE** key to display **MW**.

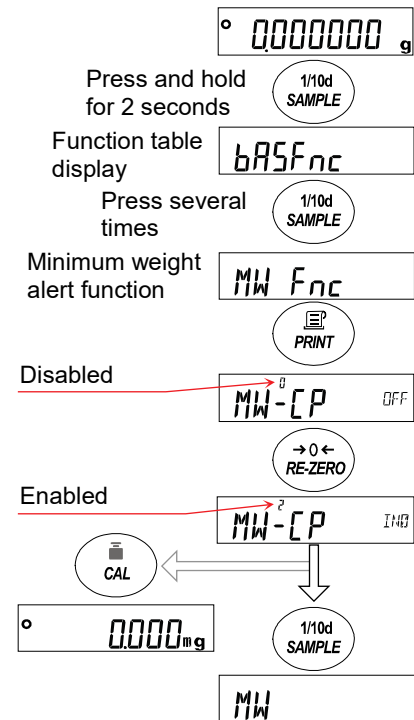

12.2. Inputting and outputting the minimum weight

12.2.1. Setting procedure using the function table

Inputting the set value directly

Continue from step 6 of "12.1. Enabling the minimum weight comparison".

- Step 7. With **MW** displayed, press the **PRINT** key to display **KEY in**.
- Step 8. Select either operation:
 - To set the minimum weight, press the **PRINT** key to proceed to step 9.
 - To return to weighing mode without setting the minimum weight, press the **CAL** key twice.
- Step 9. Set the minimum weight using the following keys.
 - RE-ZERO** (+) key Changes the value of the blinking digit.
 - MODE** (-) key Changes the value of the blinking digit.
 - SAMPLE** key Selects the digit to blink.
 - PRINT** key Stores the value and proceeds to the next item.
 - CAL** key Cancel the setting and proceeds to the next item.

Note. If **MW-CP OFF** is set, it will be automatically changed to **MW-CP EX0** (Enables comparison excluding near zero) and the minimum weight comparison function will be enabled.

- Step 10. Press the **CAL** key to return to weighing mode.

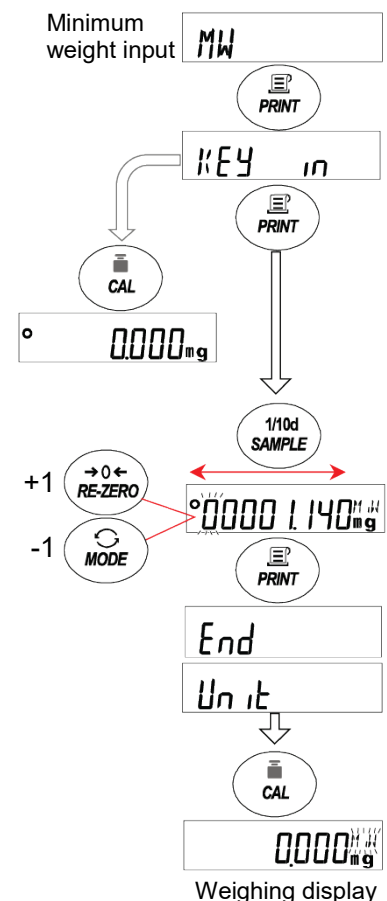

Input using repeatability with an external weight

Continue from step 6 of "12.1. Enabling the minimum weight comparison".

Step 7. With **MW** displayed, press the **PRINT** key to display **KEY in**.

Step 8. Press the **SAMPLE** key to display **EXT MASS**.

Step 9. Press the **PRINT** key. **START**, **READY**, and zero display are shown in order.

Step 10. Place the weight when **LOAD** is displayed requesting the first load for repeatability measurement.

When the processing indicator (◀) is lit, starts blinking and then remains stable for 2 seconds, the weighing value (span) is displayed.

REMOVE displays blinking.
Remove the weight.

When the processing indicator (◀) is lit and starts blinking and then remains stable for 2 seconds, the zero is displayed.

Step 11. Repeat step 10 ten times.

Step 12. When the 10th span is displayed, remove the weight.

REMOVE and **End** appear in this order.
The minimum weight **MW^{0.1%} 0.960_{mg}** is displayed.

Minimum weight input **MW**



KEY in



EXT MASS



START

READY

Zero point **0.000000 g**

LOAD

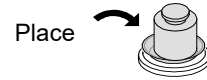

1st load **LOAD**

LOAD

Weighing value **1234567 g**

REMOVE



REMOVE

REMOVE

0.000000 g

10th load **LOAD**

LOAD

Weighing value **1234567 g**

REMOVE

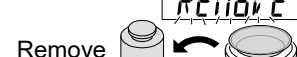

End

Minimum weight **MW^{0.1%} 0.960_{mg}**

Error messages

-E display	Load exceeding the capacity is applied.	The balance returns to repeatability measurement when the error is cleared.
E display	Not enough load is applied.	
Error 1 display	Weighing value unstable (for approx. 30 seconds) during repeatability measurement	After ERROR is displayed the balance will force end repeatability measurement and return to the function table.
-	Timeout (after approx. 2 minutes of inactivity)	

Step 13. The repeatability (5 σ) and minimum weight (MW) can be selected and output.

With $MW \overset{0.1\%}{0.960}mg$ displayed, press the **SAMPLE** key to switch between the minimum weight (MW) and repeatability (5 σ).

Press the **MODE** key to switch the measurement tolerance.

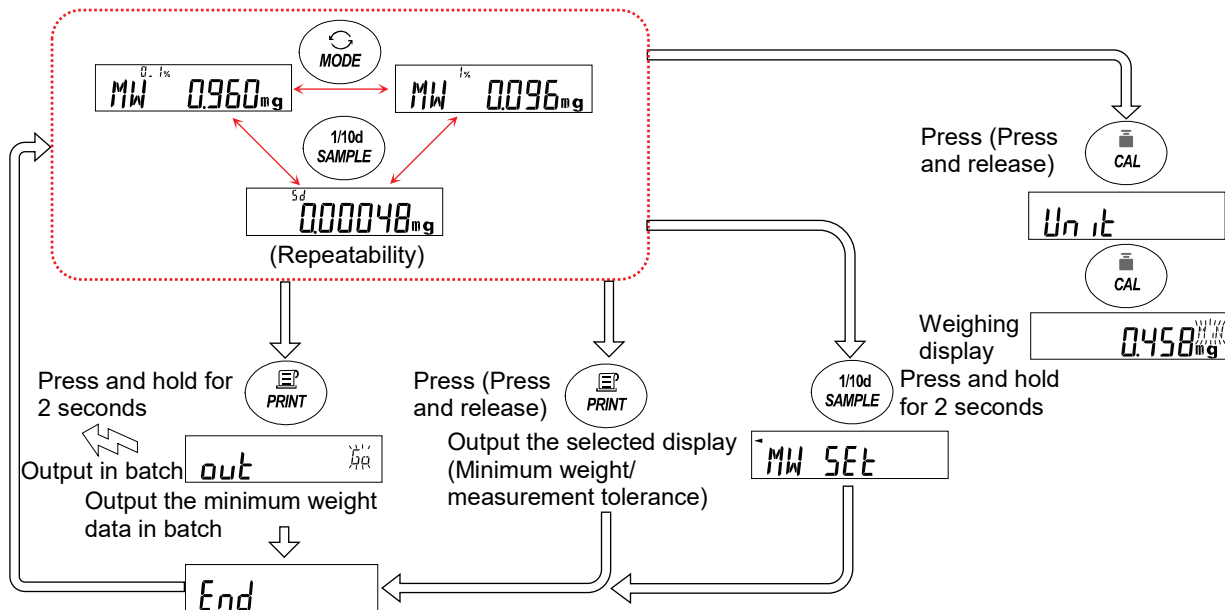

Step 14. To output the display selected in step 13 (repeatability "5 σ " / minimum weighing value "MW"), press the **PRINT** key.

To output the data in batch, press and hold the **PRINT** key for 2 seconds.

Step 15. When the output is completed, $MW \overset{0.1\%}{0.960}mg$ is displayed.

Step 16. Press and hold the **SAMPLE** key for 2 seconds to store the minimum weight and return to $MW \overset{0.1\%}{0.960}mg$ display.

Note. If $MW-CP \ 0$ is set, the parameter is automatically changed to $MW-CP \ 1$ (excluding near zero), and the minimum weight comparison function is enabled.

Step 17. Press the **CAL** key twice to enter weighing mode with the minimum weight alert function enabled.

12.2.2. Setting procedure in weighing mode

Step 1. In weighing mode, press the **MODE** key.
When MW is displayed, press the **PRINT** key.

Step 2. $KEY \ in$ appears.

Follow the steps after step 8 of "Inputting the set value directly" or "Input using repeatability with an external weight" in "12.2.1. Setting procedure using the function table" to set the minimum weight value.

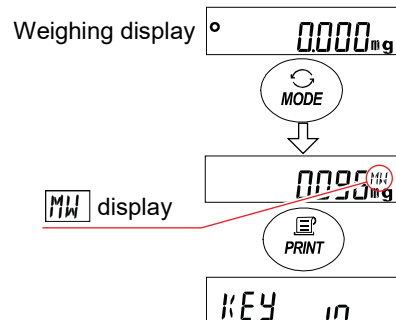

12.2.3. Outputting the setting values in batch

The set minimum weighing value and repeatability result can be output in batch.

Step 1. With **KEY in** or **Ext MASS** displayed, press and hold the **PRINT** key for 2 seconds.

Step 2. Pressing the **REZERO** key toggles between **Na** / **Go** in the **out** display. Select **Go** and press the **PRINT** key to output the setting values in batch.

Step 3. When the batch output is completed, **End** appears and then the display returns to **KEY in** or **Ext MASS**.

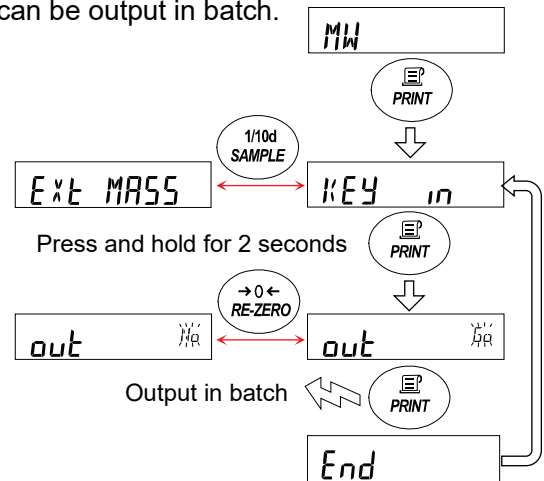

Example of batch output of the set minimum weighing value

The output content depends on the minimum weight setting method.

Set with **KEY in**

```

-MINIMUM WEIGHT-
                A & D
MODEL          BA-6E
S/N           123456789
ID LAB-012345678
DATE  2020/12/12
TIME   12:34:56

KEY INPUT

MINUM WEIGHT
        0.096 mg

REMARKS

SIGNATURE
-----
    
```

Set with **Ext MASS**

```

-MINIMUM WEIGHT-
                A & D
MODEL          BA-6E
S/N           123456789
ID LAB-012345678
DATE  2021/05/12
TIME   12:34:56

EXTERNAL MASS

RESULT
1  +1.000001  g
2  +1.000000  g
3  +1.000000  g
4  +1.000001  g
5  +1.000000  g
6  +1.000000  g
7  +1.000000  g
8  +1.000001  g
9  +1.000000  g
10 +1.000000  g

SD      0.00048 mg

TOLERANCE
        0.10  %
MINUM WEIGHT
        0.960 mg

REMARKS

SIGNATURE
-----
    
```

12.3. Outputting data less than the minimum weight

Output of the data less than the minimum weight can be switched ON/OFF with the **M in out** setting of the function table.

Setting procedure

Step 1. Press and hold the **SAMPLE** key for 2 seconds to display **bRSFnC**.

Step 2. Press the **SAMPLE** key several times to display **MW FnC**, and then press the **PRINT** key.

Step 3. Press the **SAMPLE** key several times until **M in out** is displayed.

Step 4. Press the **RE-ZERO** key to select either **M in out ON** (data output ON) or **M in out OFF** (data output OFF).

Step 5. To proceed to the next item, press the **PRINT** key.

Step 6. To return to weighing mode, press the **CAL** key.

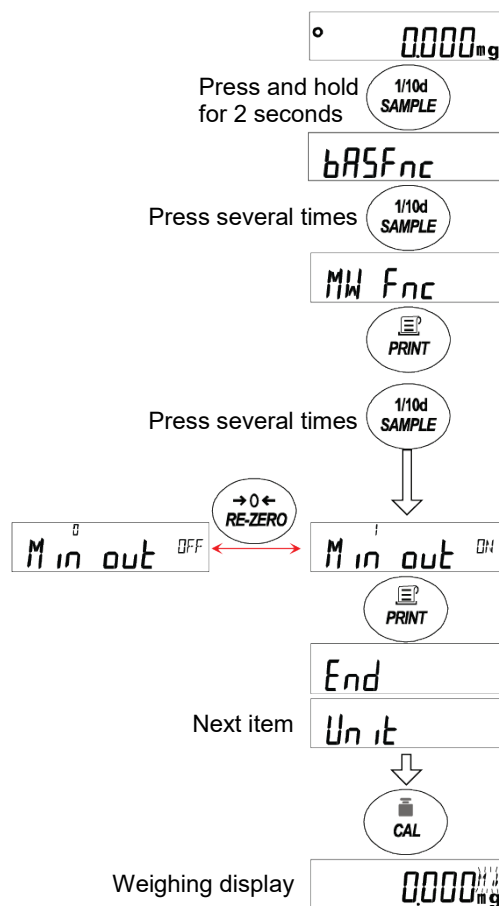

13. Underhook

The built-in underhook is used for underhook weighing such as measurement of magnetic materials and the like.

To use the underhook, open the cap on the bottom of the balance.

Caution

- Do not apply excessive force to the underhook part.
- Do not open the cap unless necessary. (For protection from dust)
- The underhook can be used only in the hanging direction (pulling direction).
- If the balance is tilted greatly, attached parts such as the weighing pan will come off. Remove them before work.
- Keep in mind that draft enters the balance easily when the underhook cap is removed, affecting the weighing values.

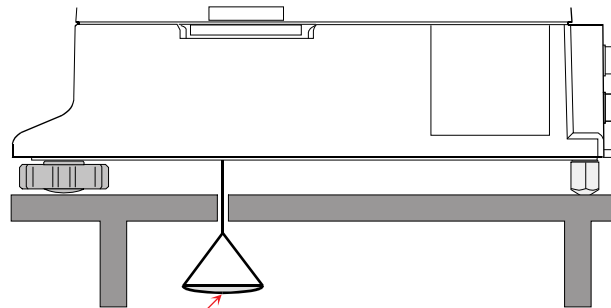

Example of
underhook weighing pan

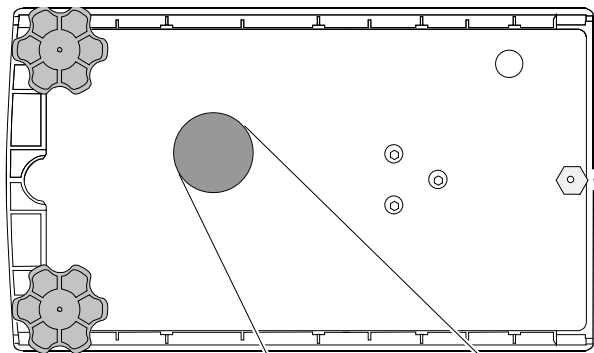

Underhook
(Hole diameter: approx. 4 mm)

Cap

14. Password Function

Intended use

- The password function allows you to restrict the use and functions of the balance. It is effective in preventing falsification of date and time settings or preventing changes in the function table by the user.

Entering a password

- Enter a 4-digit password using the five keys. 625 combinations are available (5 x 5 x 5 x 5 = 625).
Five keys: **MODE**, **SAMPLE**, **PRINT**, **TARE**, **RE-ZERO**

Function settings

- The password function is disabled at factory setting.
The password function (enabled/disabled) and password registration can be set in the function table, "PW" of "Password function (PASSWORD)".

PW 0	No password
PW 1	Administrator password required to change the settings

Description of the settings

PW 0 No password

- The password function is not used. The balance can be used for weighing operations by anyone. All the functions are available. It is also possible to change the settings of the balance.

PW 1 Administrator password required to change settings

- The balance can be used for weighing by anyone, but initialization and setting change (including clock) are restricted. No password is required to start weighing with the **ON:OFF** key.
- The Administrator (**ADM^{IN}**) can limit users of the balance by setting individual passwords.
At the factory setting, the password of the Administrator (**ADM^{IN}**) is set to **7777**, which is entered by pressing the **RE-ZERO** key four times.
- If weighing is started by pressing the **ON:OFF** key while holding down the **CAL** key when the display is turned off, the user will be prompted to enter a password.
- Disabled functions will require the user to log in. When logged in by an authorized user, the login status will continue thereafter. When logged in by an unauthorized user, the user will not be changed.
- There are three login levels: Administrator (**ADM^{IN}**), User (**USER 01** to **USER 10**), and Guest (**GUEST**).

Administrator (ADM^{IN})	All functions and settings are available.
User (USER 01 to USER 10)	Restrictions on setting changes (including the clock) can be set for each user. Initialization and password functions are restricted.
Guest (GUEST) No password	Initialization and setting changes are (including the clock) restricted.

- Restrictions by login level

Login level	Administrator (ADM^{IN})	User (USER 01 to USER 10)	Guest (GUEST)
Weighing operation	Available		
Internal weight value	Enabled *2	Selectable	Disabled
Auto CAL			
External weight CAL			
Internal weight CAL			
Function table *1			
Function selection/Initialization	Enabled		

*1 The password function is only allowed for the Administrator (**ADM^{IN}**).

*2 For details on the function selection switch for the Administrator (**ADM^{IN}**), refer to "7.1. Function selection switch".

14.1. Enabling the password function

The password function can be switched between "Disabled (OFF)" and "Enabled (ON)" in "Password function (PASSWORD)" of the function table.

- Step 1. In weighing mode, press and hold the **SAMPLE** key for 2 seconds to display **bASFnC**.
- Step 2. Press the **SAMPLE** key several times to display **PASSword** and then press the **PRINT** key. (To cancel, press the **CAL** key.)
- Step 3. Password OFF (**PW⁰ OFF**) is displayed. Press the **RE-ZERO** key to switch between ON and OFF. With Password ON (**PW¹ ON**) displayed, press the **PRINT** key. ("0" blinks when OFF is selected. "1" blinks when ON is selected.)
- Step 4. Password lock OFF (**SURE YES^{NO}**) is displayed. Press the **RE-ZERO** key to switch between YES and NO. With Password lock ON (**SURE YES^{NO}**) displayed, press the **PRINT** key. ("NO" blinks when OFF is selected. "YES" blinks when ON is selected.)
- Step 5. **ADM^{IN}** is displayed. To register (change) passwords, proceed to step 4 of "14.4. Registering (changing) the password". To return to weighing mode without registering (changing) a password, press the **CAL** key twice.

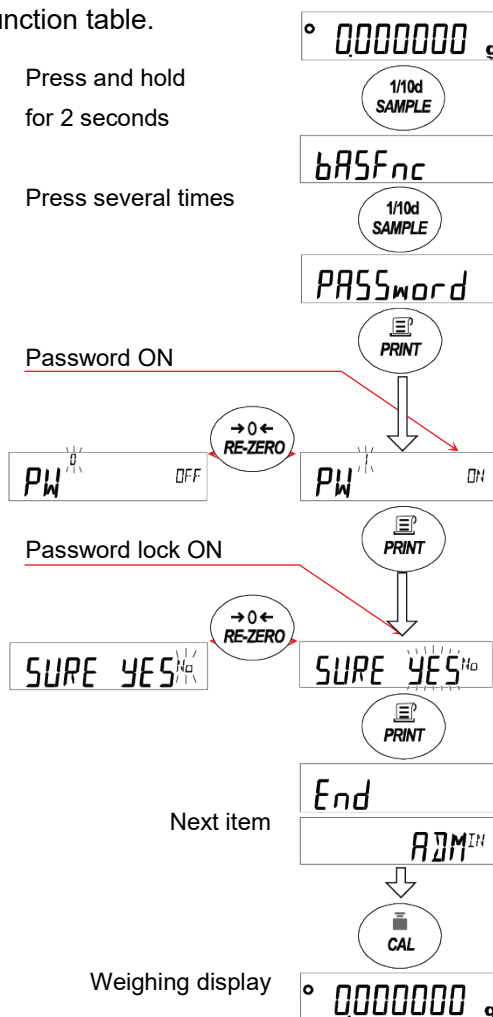

14.2. Entering a password at the start of weighing

Logging in at the Guest (GUEST) level

Step 1. With the display turned off, press the **ON:OFF** key.

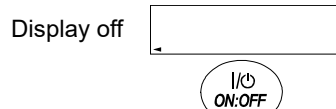

Step 2. **in : GUEST** is displayed and the balance enters weighing mode.

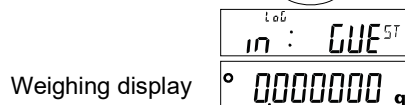

Logging in at the Administrator (ADMIN) or User (USER) level

Step 1. With the display turned off, while holding down the **CAL** key, press the **ON:OFF** key.

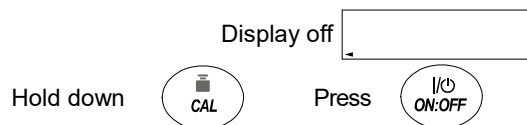

Step 2. Enter a 4-digit password using the following keys. Note that the display will turn off after 10 minutes of inactivity.

- MODE** key Enters "M"
- SAMPLE** key Enters "S"
- PRINT** key Enters "P"
- TARE** key Enters "t"
- RE-ZERO** key Enters "Z"
- CAL** key Back key

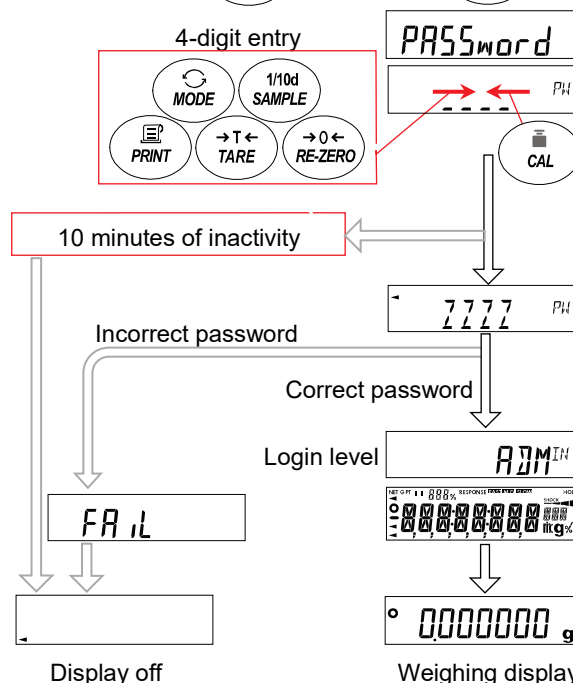

Step 3. When the correct password is entered, the login level, all segments/indicators, and weighing display are displayed in order. If the password is incorrect, **FAIL** is displayed and the buzzer sounds three times, and then the display turns off.

Note. At the factory setting, the password of the Administrator level is set to "7777", which is entered by pressing the **RE-ZERO** key four times.

14.3. Logging out

Step 1. To log out, press the **ON:OFF** key. The display turns off.

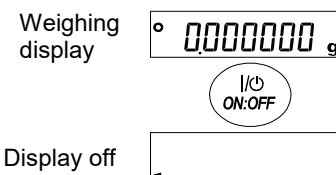

14.4. Registering (changing) the password

The password can be changed in "Password (PASSNo.)" of the function table.

Step 1. In weighing mode, press and hold the **SAMPLE** key for 2 seconds to display **bASFnC**.

Step 2. Press the **SAMPLE** key several times until **PASSword** is displayed.

Step 3. Press the **PRINT** key to display **PW**.

Step 4. Press the **SAMPLE** key to display the login level (**ADM^{IN}**, **USER 01** to **USER 10**) that you want to change, then press the **PRINT** key to display **PASS No.**
If the login level already has a registered password, the stability indicator "●" lights. (It can be changed.)

Step 5. To change the setting, refer to "14.5. Changing the Function selection switch by user password", "14.8. Function selection switch by user", or "14.6. Deleting the password".

To finish setting and return to weighing mode, press the **CAL** key three times.

Caution

- When the display is turned off by pressing the **ON:OFF** key, the user is logged out.

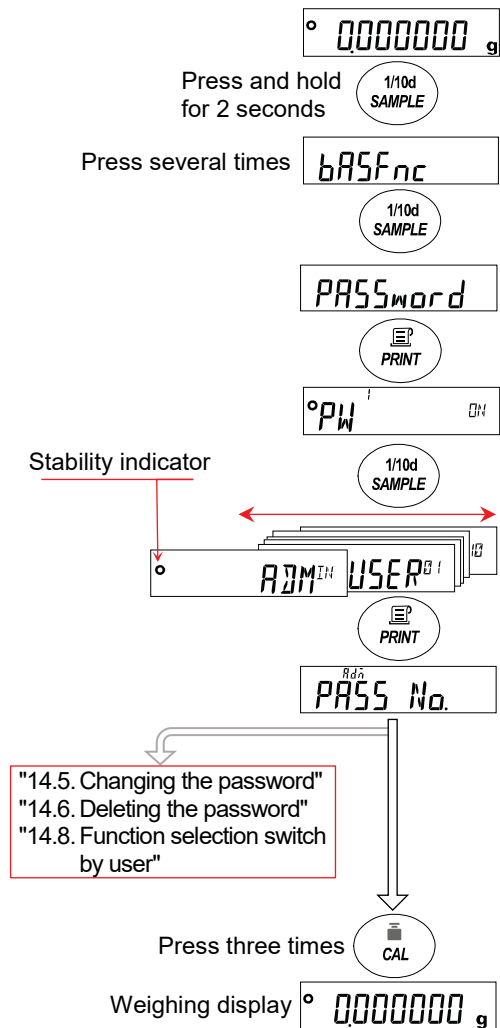

14.5. Changing the password

Step 1. Refer to "14.4. Registering (changing) the password" and display the login level at which you want to change the password.

Step 2. With **PASS No.** displayed, press the **PRINT** key to display the current password.

Note. The default password for the Administrator level is set to "7777" entered by pressing the **RE-ZERO** key four times.

Step 3. Set a new 4-digit password using the following keys. Note that the display will turn off after 10 minutes of inactivity.

MODE key Enters "M"
SAMPLE key Enters "5"
PRINT key Enters "P"
TARE key Enters "t"
RE-ZERO key Enters "7"
CAL key Back key

Step 4. After entering the four digits with the keys, the new password will be displayed. (To return to the 4th digit entry, press the **CAL** key.)

Step 5. Password lock OFF (**SURE YES^{OFF}**) is displayed. Press the **RE-ZERO** key to switch between ON and OFF. With password lock ON (**SURE YES^{ON}**) displayed, press the **PRINT** key. ("No" blinks when OFF is selected. "YES" blinks when ON is selected.)

Step 6. When the setting is completed, **PASS No.** is displayed. To continue the setting, start from step 1. To finish setting, press the **CAL** key three times to return to weighing mode.

Caution

- If the password is lost or forgotten, the balance will become unusable. Be sure to record, save and manage the registered password. The same password that has already been registered cannot be registered.
- For details on how to delete the password, refer to "14.6. Deleting the password (USER 01 to USER 10)".

"14.4. Registering (changing) the password"

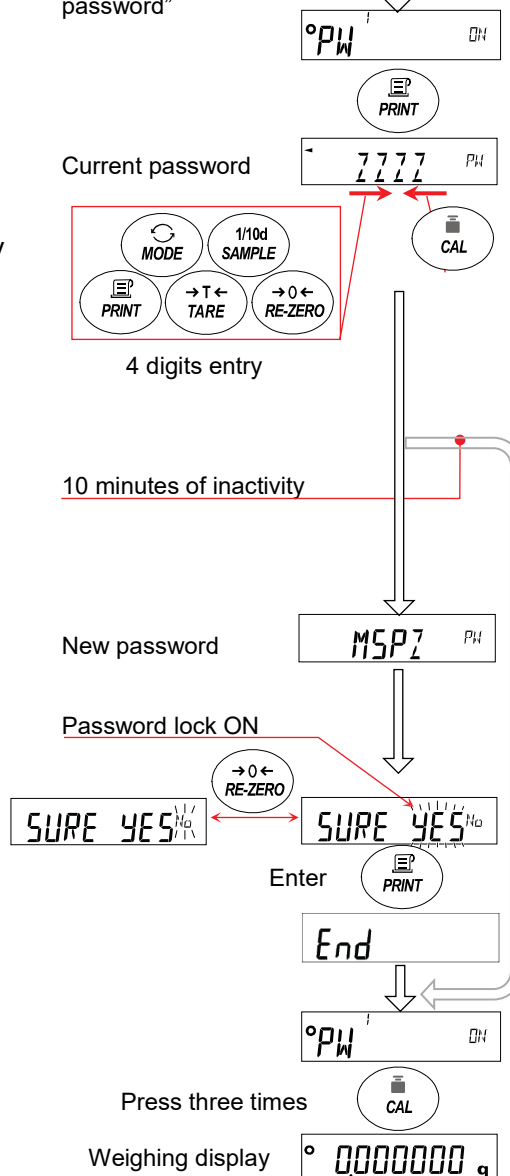

14.6. Deleting the password (USER 01 to USER 10)

Step 1. Refer to "14.4. Registering (changing) the password" and select the User (USER 01 to USER 10) whose password you want to delete.

Step 2. With **PASS No.** displayed, press the **PRINT** key to display the password entry display. Press and hold the **CAL** key for 2 seconds until **CLEAR** is displayed (blinking).

Step 3. Press the **RE-ZERO** key to switch between "0" for deleting and "No" for not deleting. Pressing the **PRINT** key while "0" is blinking will delete the password.

Step 4. To finish the setting and return to weighing mode, press the **CAL** key three times.

"14.4. Registering (changing) the password"

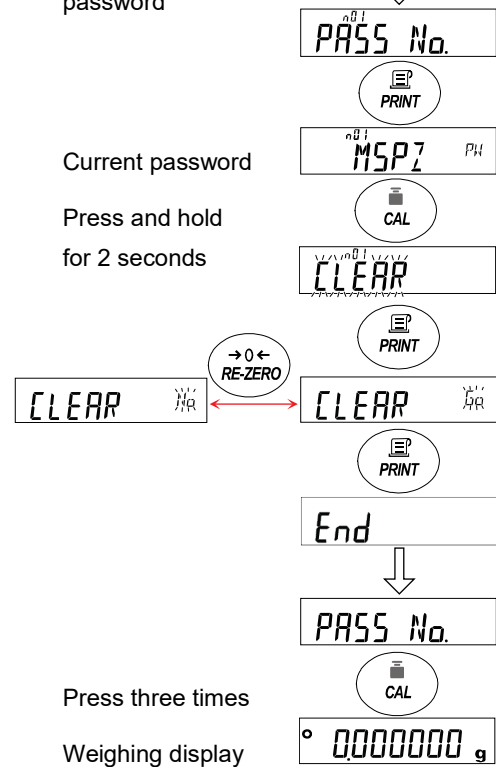

Caution

- The Administrator password cannot be deleted. Change it to a new password by referring to "14.4. Registering (changing) the password" and "14.5. Changing the password".

14.7. If the password is lost or forgotten

If the password is lost or forgotten, the balance cannot be used. Contact your local A&D dealer to reset the password.

14.8. Function selection switch by user (ADMIN, USER 01 to USER 10)

- Step 1. Refer to "14.4. Registering (changing) the password" and select the user (ADMIN *1, USER 01 to USER 10) whose function you want to limit.
- Step 2. With **PASS No.** displayed, press the **SAMPLE** key.
- Step 3. For the User (USER) or Guest (GUEST), **PW-PS** is displayed. For the Administrator (ADMIN), **PS** is displayed.
- Step 4. Press the **PRINT** key. Select the function using the following keys.

- SAMPLE** key Selects the blinking digit (switch).
- RE-ZERO** key..... Changes the condition of the switch.
 0 Prohibit changes/Prohibit use
 1 Allow changes/Allow use
- PRINT** key Stores the setting and returns to the **PW-PS** or **PS** display.
- CAL** key Cancels the setting and returns to the **PW-PS** or **PS** display. To return to weighing mode, press the **CAL** key again.

"14.4. Registering (changing) the password"

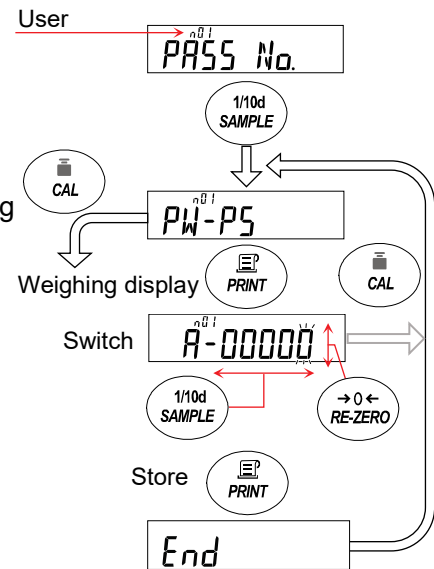

- *1 The function selection switch of ADMIN (**PS**) is linked with the setting of "7.1. Function selection switch". If either is switched to allow or prohibit, the change will be reflected in both. In addition, functions prohibited by ADMIN are prohibited for all users.

Function selection switch

Display for USER at factory setting For the Administrator (ADMIN), refer to "7.1. Function selection switch".

A-01111

Function table

- 0 : Prohibit changes to the function table.
 1 : Allow changes to the function table.

Sensitivity adjustment using the internal weight

- 0 : Prohibit sensitivity adjustment using the internal weight.
 1 : Allow sensitivity adjustment using the internal weight.

Sensitivity adjustment using an external weight

- 0 : Prohibit sensitivity adjustment using an external weight.
 1 : Allow sensitivity adjustment using an external weight.

Automatic sensitivity adjustment

- 0 : Prohibit automatic sensitivity adjustment.
 1 : Allow automatic sensitivity adjustment.

Internal weight value correction

- 0 : Prohibit internal weight value correction
 1 : Allow internal weight value correction

14.9. Password function operation

The following are examples of operations when the **CAL** key is pressed using the password function.

Example 1 (when logged in as *USER 01* at the User level)

Case 1. If the logged in user and the Administrator are also allowed, **CAL in** will be operated.

Case 2. If the Administrator is not allowed, the **CAL** key will not respond.

Case 3. If the logged in user is not allowed but the Administrator is allowed, the password will be required.

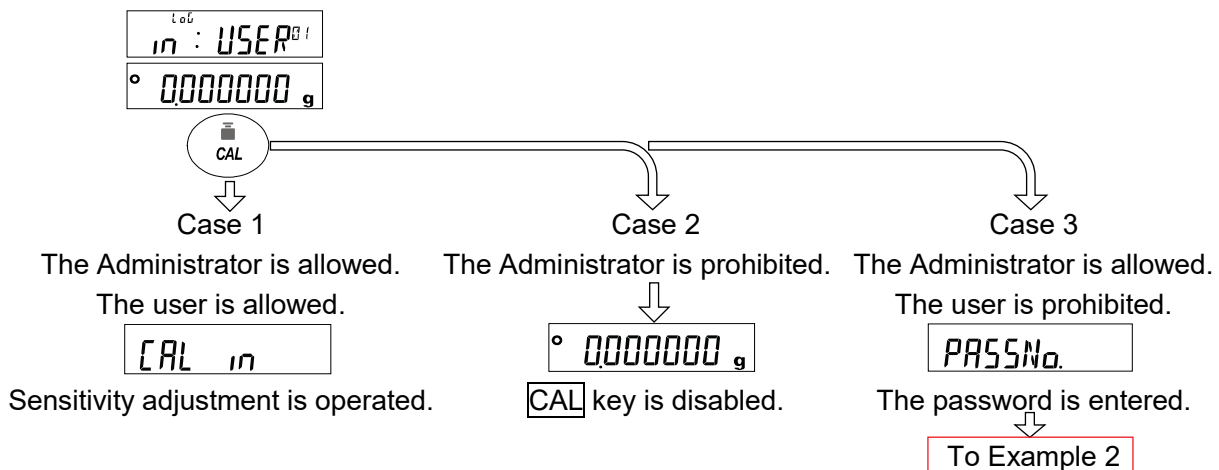

Example 2 (when the password of *USER 02* is entered while logged in as *USER 01* at the User level)

Case 4. If the password entered in Case 3 of Example 1 is correct and *USER 02* is not allowed, **NotALLOW^{ED}** will be displayed. The logged in user will not be changed, and the balance will return to weighing mode.

Case 5. If the password entered in Case 3 of Example 1 is correct and *USER 02* is allowed, the logged in user will be changed from *USER 01* to *USER 02* and **CAL in** will be operated.

Case 6. If the password entered in Case 3 of Example 1 is incorrect, **FAIL** will be displayed and the buzzer will sound three times. The balance will return to weighing mode.

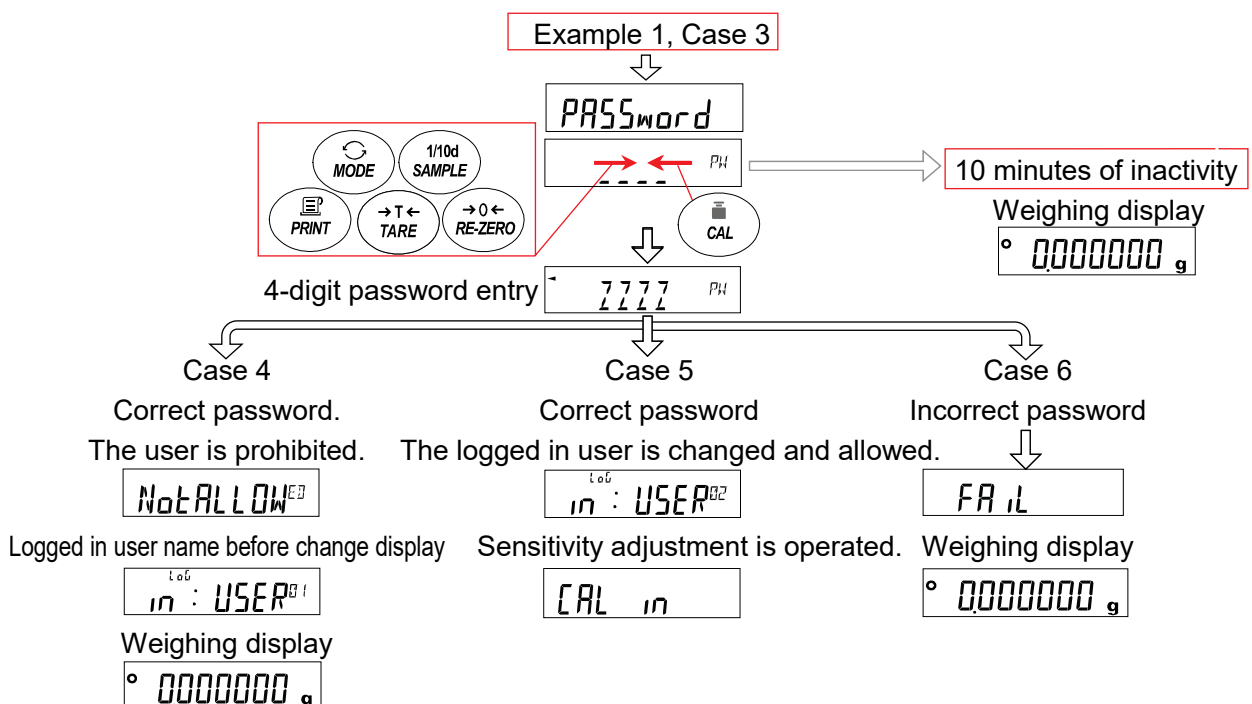

15. Repeatability Check Function

Repeatability is an index of variation in measured values when the same mass is repeatedly loaded and unloaded, and is usually expressed as the standard deviation (σ_{n-1}). The BA series have an internal weight.

The repeatability check function uses the internal weight to acquire measurement data 10 times and displays the standard deviation. By using this function with the installed balance, repeatability in the installation environment can be checked.

Example. "Standard deviation = 10.0 mg" shows that the results of repeated measurements of the same sample fall within the range of ± 10.0 mg with a frequency of about 68%.

Step 1. In weighing mode, press and hold the **SAMPLE** key for 4 seconds. Release the key when **rEP tEst** is displayed.

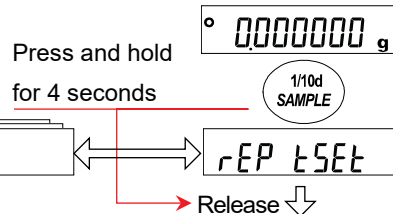

Step 2. When **rEP tEst** is displayed, data collection starts automatically. **rEP** is blinking while data is being collected. To cancel it, press the **CAL** key. **CANCEL** appears and the balance returns to weighing mode.

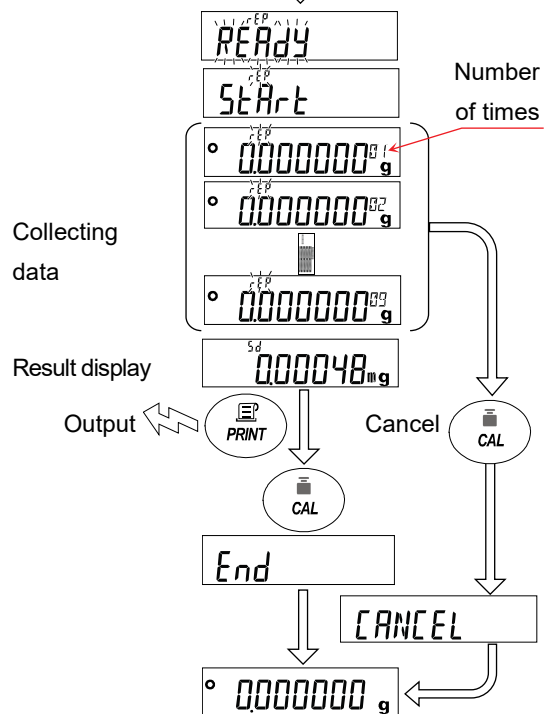

Step 3. When data collection is completed, repeatability (standard deviation) is displayed.

Step 4. Press the **PRINT** key to output repeatability (standard deviation).

Step 5. Press the **CAL** key to return to weighing mode.

Note

Consider the result of this function as a reference value because the condition where the internal weight of the balance (BA-6E/BA-6DE with about 5 g or BA-225D/ BA-225/BA-125D with about 100 g) is used is different from the condition of the repeatability listed in "29. Specifications". In order to measure data correctly, do not apply vibration or drafts while collecting data. With the password function enabled, only logged in user who is allowed to operate the function table can use this function.

16. Interface Specification (Standard)

16.1. RS-232C

Connector	D-Sub 9-pin (male)		
Transmission system	EIA RS-232C		
Transmission form	Asynchronous, bi-directional, half duplex		
Transmission rate	Approx. 5 times/second (5 Hz) or approx. 10 times/second (10 Hz) (Linked with "Display refresh rate ($5F_d$)" of "Environment/Display ($bR5F_{nc}$)" in the function table)		
Signal format	Baud rate	600, 1200, 2400, 4800, 9600, 19200, 38400 bps	
	Data bits	7 bits or 8 bits	
	Parity	EVEN or ODD.....At a data bit length of 7 bits NONEAt a data bit length of 8 bits	
	Data bit length	1 bit	
	Code	ASCII	

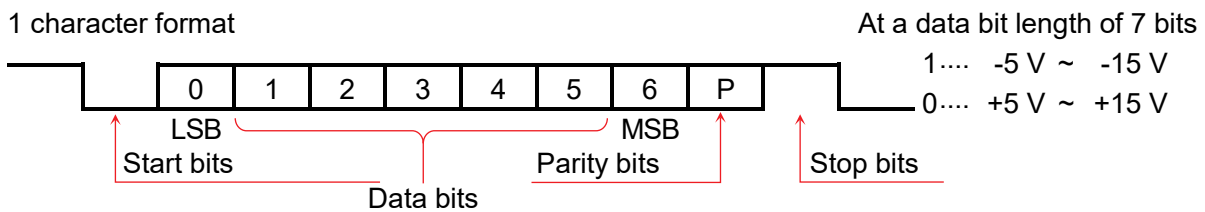

D-Sub 9-pin assignments

Pin No.	Signal name	Direction	Description
1	-	-	Same potential as SG *1
2	TXD	Output	Transmit data
3	RXD	Input	Transmit data
4	-	-	No connection
5	SG	-	Signal ground
6	DSR	Output	Data set ready
7	RTS	Input	Request to send
8	CTS	Output	Clear to send
9	-	Output	12V output *1

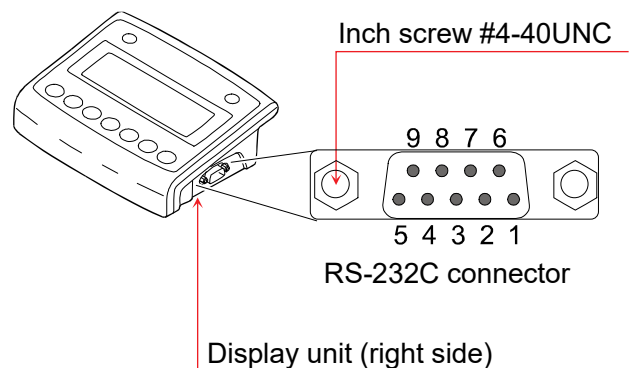

Signal names other than TXD and RXD are names on the DTE side.

Wiring diagram
(when connected to a personal computer)

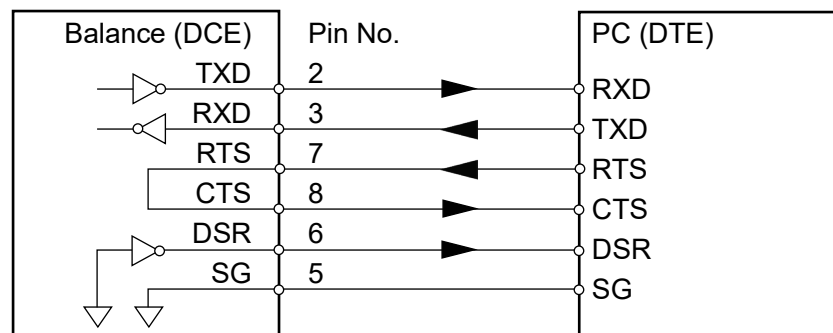

*1 Used with some of the A&D peripherals. When connecting to other companies' products such as personal computers and PLCs, do not connect the wires. Make sure a compatible cable is used, as using the wrong connection cable may damage the device.

16.2. USB

Connector	Mini-B USB (female)	
Specification	USB 2.0	
Device class	HID (Human Interface Device):	Quick USB
	CDC (Communication Device Class):	Virtual COM

Mini-B USB pin assignment

Pin No.	Signal name	Direction	Description
1	VBUS	Input	Power
2	D-	-	Sent/received data
3	D+	-	Sent/received data
4	ID	-	N. C.
5	GND	-	Signal ground

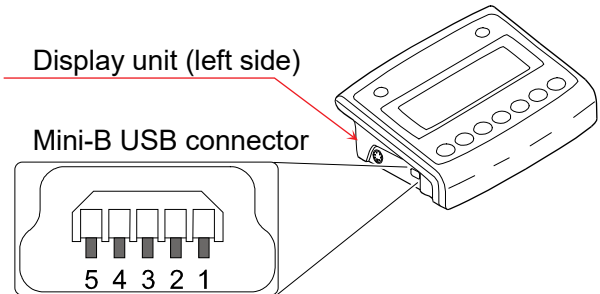

16.3. External input terminal

- The external input terminal provides the functions "RE-ZERO" key input on the balance", "PRINT" key input", and "opening and closing the breeze break doors" to the "contact input" via the wire extended from the connected plug.
- To turn the "contact input" on, short it for 100 ms or more.
- To use the external input terminal, you must select the function in the "External switch (EX.SW)" of the function table.
- The display unit has two external input terminals: EX.SW1 and EX.SW2.
- A foot switch (AX-SW137-PRINT) that functions as an optional PRINT key (sold separately) is available.
- A foot switch (AX-SW137-REZERO) that functions as an optional RE-ZERO key is available.
- For the plug connected to the external input terminal, a $\phi 3.5$ mm stereo plug MP-013LC (Marushin Electric Mfg. Co., Ltd) or an equivalent product can be used.

Caution

- Plugs are not included. If you prepare the plug yourself, you need to solder the plug, wire, switch, etc. yourself.

Circuit diagram of external input terminals in the display unit

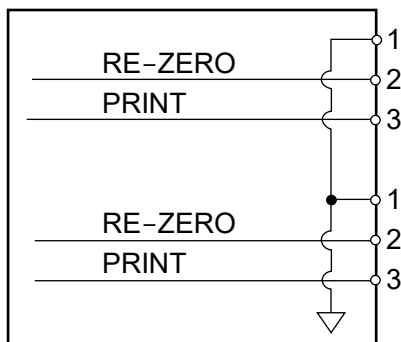

External input terminals of the display unit

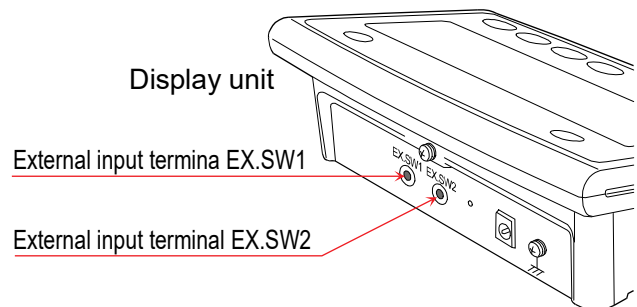

Example of compatible plug

Pin assignment

Pin	Description
1	GND common ground terminal
2	RE-ZERO external contact input
3	PRINT external contact input

Circuit diagram

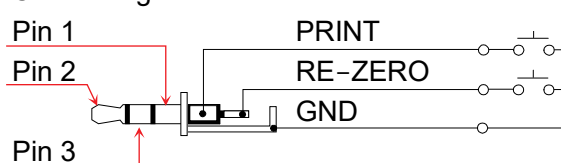

External view

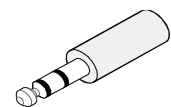

Information. "External switch (E×SW)" of the function table of the balance

Class	Item	Parameter	Description
E×SW External Switch [21]	SW1 Ex.SW1 function selection	■ 0	RE-ZERO/PRINT key *
		1	Opens/closes the left breeze break door.
		2	Opens/closes the right breeze break door.
	SW2 Ex.SW2 function selection	■ 0	RE-ZERO/PRINT key *
		1	Opens/closes the left breeze break door.
		2	Opens/closes the right breeze break door.

* The AX-SW137-PRINT (sold separately) functions as the PRINT key on the balance when connected. The AX-SW137-REZERO (sold separately) functions as the RE-ZERO key on the balance when connected.

■ Factory setting. "d" is a unit of readability.

The number in [] is the classification number. It is output as an identifier when outputting function table information in batch. Refer to "8.4.1. Batch output of the function table information".

17. Connection with Peripheral Devices

BA series analytical balances are equipped with an RS-232C connector and a mini-B USB connector that allow connection to peripherals, personal computers, PLCs, etc.

17.1. Cables required to connect to peripheral devices

The connection cables that match the interface used with the peripheral device are as follows.

Peripheral and connection cable compatibility table

Peripherals		Communication interface to use	Connection cable		Note
Product name	Model		Standard or sold separately	Cable model	
Multi-functional compact printer	AD-8127	RS-232C	[Standard accessory] RS-232C cable included with the printer	AX-KO2741-100	*1
PLC			[Sold separately]		*2 *3
PC		USB	[Standard accessory] USB cable included with the balance	AX-KO5465-180	

Note

- *1 When using the AD-8529PR-W (Bluetooth converter, sold separately), the RS-232C cable that comes with the printer is not used.
- *2 Check the interface specifications of the BA series and PLC, and prepare a compatible cable.
- *3 Can be connected to a personal computer using AX-USB-9P/AD-8529PC-W/AD-1688/AD-8527. When transferring data, the connection cable that comes with those products can be used.

17.2. Data output method

The operation of the balance can be changed by setting the function table to the settings suitable for the intended use. For details on the function table, refer to "8. Function Table".

- The output method of weighing data via the RS-232C/USB interface can be specified in "Data output mode (*Prt*)" of the function table.

Table of the data output mode

Class	Item	Parameter	Description	
<i>dout</i> Data output	<i>Prt</i> Data output mode	■ 0	Key mode	Outputs with the PRINT key if the weighing value is stable.
		1	Auto print mode A (Reference = zero)	Automatically outputs if weighing value is stable (referencing zero)
		2	Auto print mode B (Reference = the latest stable value)	Automatically outputs if weighing value is stable (referencing latest stable value)
		3	Stream mode	Outputs continually
		4	Key mode B (Immediate output)	Immediately outputs with the PRINT key regardless of whether or not the weighing value is stable.
		5	Key mode C (Output when stable)	Immediately outputs with the PRINT key. If weighing value is not stable, outputs once it has stabilized.
		6	Interval output mode	Starts outputting with the PRINT key at the specified period.

- Factory setting

17.3. Examples: Connecting multiple peripheral devices

17.3.1. Printer and personal computer connection

Table of settings by connection method

Connection method		Function table for the connection interface/connected device			
Interface	Device	Class	Item	Parameter	Description
(Common settings)		<i>dout</i> Data output	<i>Prt</i> Data output mode	0 - 6	Selects the data output mode suitable for the intended use and settings of the printer/personal computer *1
RS-232C	Printer	<i>SIF</i> Serial interface	<i>TYPE</i> Data format	0, 1	Selects the data output format suitable for the settings of the printer and applications. (A&D standard format, DP format)
USB	PC	<i>USB</i> USB interface	<i>U-TP</i> USB data format	0 - 7	Selects an output format that allows the personal computer to process easily

*1 The data output mode is an item common to the printer and personal computer. The weighing value is output at the same timing.

Connecting the printer to the balance

- The AD-8127 multi-functional compact printer is a printer for balances. Connect the printer and the balance display unit with an RS-232C cable.

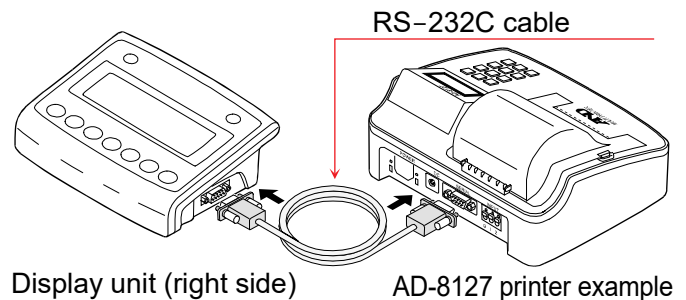

Connecting the personal computer to the balance

- To connect the balance and the personal computer only, connect with the USB cable or RS-232C cable.
- If the personal computer does not have an RS-232C interface (COM port), you can use a USB converter (AX-USB-9P).

Example of RS-232C interface of a PC

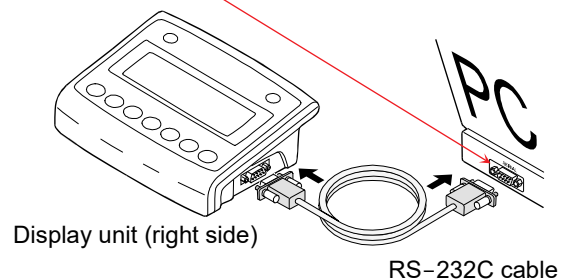

Example of USB interface of a PC

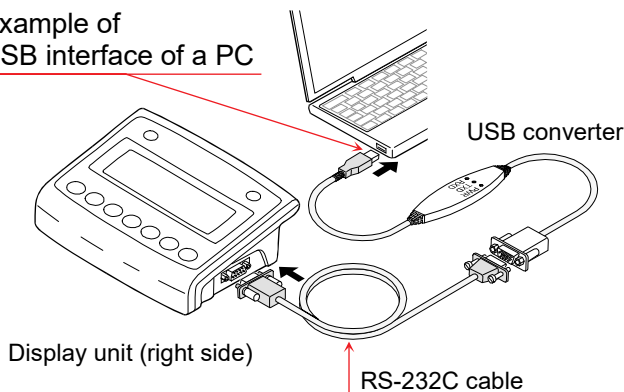

Example of USB interface of a PC

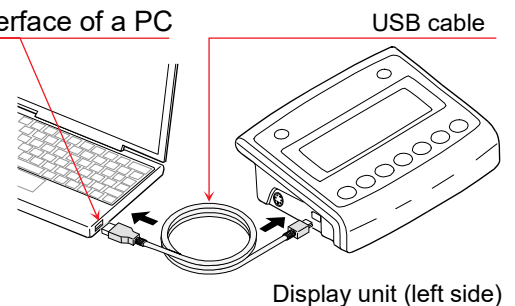

18. Printing Weighing Value Data with a Printer

Refer to the following setting examples for the printer settings and the balance's function table according to the printer to be used and the method of printing weighing data.

18.1. For an AD-8127 multi-functional compact printer

18.1.1. Printing only weighing value data

Common settings for the balance when printing only weighing value data with the AD-8127

Class	Item	Parameter	Description
5, F Serial interface	TYPE Data format	0	A&D standard format

Settings when printing only weighing value data with the AD-8127

Printing method	Balance function table			AD-8127 function table	
	Class/Item	Parameter	Description	PRN .MODE	Description
Prints weighing value data when the PRINT key of the balance is pressed.	Data output mode	0	Key mode	EXT.KEY	External key print mode
		4	Key mode B (Immediate output) *1		
		5	Key mode C (Output when stable)		
Automatically prints weighing value data according to the change in the weighing value.		1	Auto print mode A (Reference = zero)		
		2	Auto print mode B (Reference = the latest stable value)		
Prints weighing value data at regular intervals		6	Interval output mode *1		
Prints weighing value data when the PRINT key of the printer is pressed.	3	Stream mode *1	MANUAL	Manual print mode	
Prints weighing value data in chart format.			CHART	Chart print mode	

*1 Unstable data is also output.

To set the AD-8127 to a mode other than dump print mode and also print unstable data, change the setting to "Unstable data, Printed out ("US PRN", "PRINT")" in the function table of the AD-8127.

18.1.2. Printing weighing value data with the ID number and timestamp using the clock/calendar function of the balance

Common settings of the balance to print weighing value data and other information with the AD-8127

Class	Item	Parameter	Description
5, F	Serial interface	TYPE	Data format
		I	DP format

Settings of the balance to print weighing value data and other information with the AD-8127

Printing method	Balance function table			AD-8127 function table	
	Class/Item	Parameter	Description	PRN .MODE	Description
Prints weighing value data when the PRINT key of the balance is pressed.	dout Data output	0	Key mode	DUMP	Dump print mode
		4	Key mode B (Immediate output) *1		
		5	Key mode C (Output when stable)		
Automatically prints weighing value data according to the change in the weighing value.	PrL Data output mode	1	Auto print mode A (Reference = zero point)		
		2	Auto print mode B (Reference = Last stable value)		
Prints weighing value data at regular intervals		6	Interval output mode *1		

*1 Unstable data is also output.

To set the AD-8127 to a mode other than dump print mode and also print unstable data, change the setting to "Unstable data, Printed out ("US PRN", "PRINT")" in the function table of the AD-8127.

18.1.3. Printing information other than weighing value data

To print sensitivity adjustment/calibration test reports (GLP compliant output) or to perform output of the statistical calculation result calculated by the balance, change the setting of the printer to the dump print mode.

Settings to print information other than weighing value data with the AD-8127

PRN .MODE	Description
DUMP	Dump print mode

□ Switching the AD-8127 print mode (PRN MODE)

By pressing and holding the **ENTSAVE** key of the AD-8127, it is possible to switch between EXT.KEY (External key print mode) and DUMP (Dump print mode) without using the function table of the printer.

This is convenient when temporarily switching the AD-8127 to dump print mode for GLP output, etc.

19. Connecting to a Personal Computer

19.1. Quick USB mode

The quick USB mode is a function where a balance is connected to a personal computer with a USB cable and inputs the output of the balance directly to the software on the personal computer, such as Excel or Word. The supported OS is Windows 7 or later.

Since the Windows standard driver (HID) is used, there is no need to install a dedicated driver and communication is possible simply by connecting.

Caution

- Quick USB is a one-way communication from the balance to the personal computer. It is not possible to send commands to control the balance from the personal computer.
- Turn off the screen saver and standby mode of the personal computer.
- Do not use Quick USB when the data output mode of the balance is set to the stream mode.
- In stream mode, the balance keeps outputting weighing data to the personal computer. It may cause unintended operation on the computer.

Function table

- To use Quick USB mode, set "USB function mode (UF_{nc})" to "Quick USB UF_{nc} 0".

Class	Item	Parameter	Description
USB USB interface	UF_{nc} USB function mode	0	Quick USB

USB output format

- To output via USB, select the output format in "USB data format ($U-LP$)" of the function table.
- For details on the output format, refer to "20.2. Weighing data format".

Setting procedure (to send weighing data with the $PRINT$ key of the balance)

- Step 1. In the function table of the balance, set to "Quick USB UF_{nc} 0".
- Step 2. Connect the balance to the personal computer with the included USB cable.
- Step 3. When the personal computer is connected to the balance for the first time, the computer will automatically start installing the driver.
- Step 4. Start the software (Excel, etc.) used for weighing data transmission on the computer.
- Step 5. Be sure to set the keyboard to single-byte input mode. (Data cannot be entered correctly in the double-byte input mode.)
- Step 6. Place the cursor where you want to enter the weighing data.
- Step 7. Press the $PRINT$ key of the balance to send weighing data from the balance and enter it at the cursor position.
- Step 8. To finish data transmission, disconnect the USB cable.

19.2. Virtual COM mode

- Virtual COM mode is a function where a balance connected to a personal computer with the included USB cable, creates a COM port on the personal computer and performs bidirectional communication.
- The supported OS is Windows 7 or later. When using the mode for the first time on a personal computer running anything other than Windows 10, it is necessary to install the dedicated driver on the personal computer.
- "For details on installation of the USB interface "Virtual COM mode" driver for the GX-A/GF-A series, refer to our website <http://www.aandd.jp>.
- Communication equivalent to RS-232C is possible by selecting the COM port with WinCT (Windows Communication Tools Software).
In virtual COM mode, it is not necessary to set the baud rate, data bit, parity, and stop bit of the data communication software.

Caution

- When installing the driver for Virtual COM mode for the first time, it may take some time to install.

Function table

- To use the Virtual COM mode, set "USB function mode (UF_{nc})" to "Bidirectional USB Virtual COM $UF_{nc} \ 1$ " in the function table.

Class	Item	Parameter	Description
$U5b$ USB interface	UF_{nc} USB function mode	1	Bidirectional USB virtual COM

19.3. RS-232C

- The RS-232C interface of the balance is DCE (Data Communication Equipment) that can be connected to a personal computer.
The RS-232C cable to be connected is a straight type.
If the computer does not have an RS-232C connector, connect it in USB virtual COM mode.

19.4. Data communication software WinCT (USB Virtual COM mode or RS-232C)

- Windows Communication Tools Software (WinCT) is data communication software for Windows that allows you to easily receive on your computer the weighing data of the balance. Use the virtual COM mode via USB interface or the RS-232C interface for the communication settings of the personal computer.
- WinCT can be downloaded from our website <http://www.aandd.jp>.
For the installation and setup of WinCT, refer to "WinCT Setup Manual" and "WinCT Operation Manual " on our website.
- WinCT consists of three applications: "RsCom", "RsKey", and "RsWeight".

“RsCom”

- Controls the balance by sending commands to the balance.
- Displays the received data and saves it as a text file (.txt).
- Communicates with multiple balances by performing multiple operations.
- Runs at the same time as other applications. (Does not occupy the computer)
- Receives the GLP compliant output data of the balance.

“RsKey”

- Enters the weighing data of the balance directly into other applications.
- Any type of application, such as Word or Excel, can be used as long as keyboard input is possible.
- Inputs the GLP compliant output of the balance.
- The test display function allows you to use your computer as an external display for the balance.

“RsWeight”

- The received data can be graphed in real time.
- The maximum value, minimum value, average value, standard deviation, fluctuation count, etc. of the received data can be calculated and displayed.

20. Data Output

20.1. Data output mode

The timing of data output of the balance can be changed by setting "Data output mode (*Pr1*)" of the function table.

Key mode Function table *dout Pr1 0*

If the **PRINT** key is pressed when the stabilization indicator is displayed, the weighing value will be output once. At this time, the weighing value display will blink once to show that it has been output.

Auto print mode A Function table *dout Pr1 1*

If the weighing value exceeds the range from the reference "zero display" to the parameter set in "Auto print polarity (*RP-P*)"/"Auto print band width (*RP-b*)" of the function table and the stabilization indicator is displayed, the weighing value will be output once. If the **PRINT** key is pressed when the stabilization indicator is displayed, the weighing value will be output once. At this time, the weighing value display will blink once to show that it has been output.

Related function table

<i>dout</i>	<i>RP-P</i>	Auto print polarity
<i>dout</i>	<i>RP-b</i>	Auto print band width

Auto print mode B Function table *dout Pr1 2*

If the weighing value exceeds the range from the reference "the latest value with the stabilization indicator displayed" set in "Auto print polarity (*RP-P*)"/"Auto print band width (*RP-b*)" of the function table and the stabilization indicator is displayed, the weighing value will be output once. If the **PRINT** key is pressed when the stabilization indicator is displayed, the weighing value will be output once. At this time, the weighing value display will blink once to show that the data has been output.

Related function table

<i>dout</i>	<i>RP-P</i>	Auto print polarity
<i>dout</i>	<i>RP-b</i>	Auto print band width

Stream mode Function table *dout Pr1 3*

Regardless of whether the stabilization indicator is on or not, the weighing value will be output at the rate set in "Display refresh rate (*SPd*)" of the function table.

When **SPd 0** ("Display refresh rate, Approx. 5 times/second") is set in the function table, the output is at approximately 5 Hz.

Related function table

<i>bR5Fnc</i>	<i>SPd</i>	Display refresh rate
<i>5rF</i>	<i>bP5</i>	Baud rate

Caution

- Depending on the display refresh rate and baud rate, all data may not be transmitted unless the baud rate is increased.

Key mode B Function table *dout Pr1 4*

Regardless of whether the stabilization indicator is turned on or not, the weighing value will be output once when the **PRINT** key is pressed.

Key mode C

Function table *dout Prt 5*

If the **PRINT** key is pressed when the stabilization indicator is displayed, the weighing value will be output once.

If the stabilization indicator is not displayed, the weighing value will be output once the next time the stabilization indicator is turned on. At this time, the weighing value display will blink once to show that it has been output.

Interval output mode

Function table *dout Prt 5*

Regardless of whether the stabilization indicator is turned on or not, the weighing value will be output at the interval set in "Interval time (*int*)" of the function table.

Press the **PRINT** key to start output, and press the **PRINT** key again during output to stop it.

Related function table

<i>dout</i>	<i>int</i>	Interval time
<i>5 rF</i>	<i>bPS</i>	Baud rate

Caution

- Depending on the combination of "Interval time" and "Baud rate", all data may not be transmitted unless the baud rate is increased.

20.2. Weighing data format

Selecting weighing data format

You can select the output format for the RS-232C connection in "Data format (TYPE)" of the function table.

You can select the output format for the USB connection in "Data format (U-TP)" of the function table.

A&D standard format

RS-232C connection: Function table S,F TYPE 0

USB connection: Function table USb U-TP 0

- This is the standard format for sending data to peripheral devices.
- Consists of 16 characters (not including the terminator).
- The condition of the data is indicated with a 2-character header.
- The data is padded with polarity and zeros (filling the data's higher order's surplus part with zeros).
- If the data is zero, the polarity is positive.
- The unit consists of three characters.

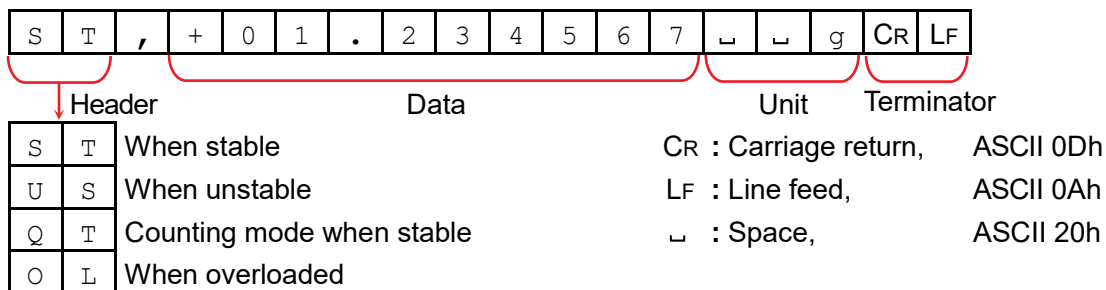

- In the external key print mode of the AD-8127 multi-functional compact printer, a received A&D standard format is printed as shown on the right.

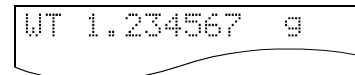

- If "Net/gross/tare output (NET)" is set to "1" to "3" in "data" of the function table, the second header corresponding to the output data is appended to the header.

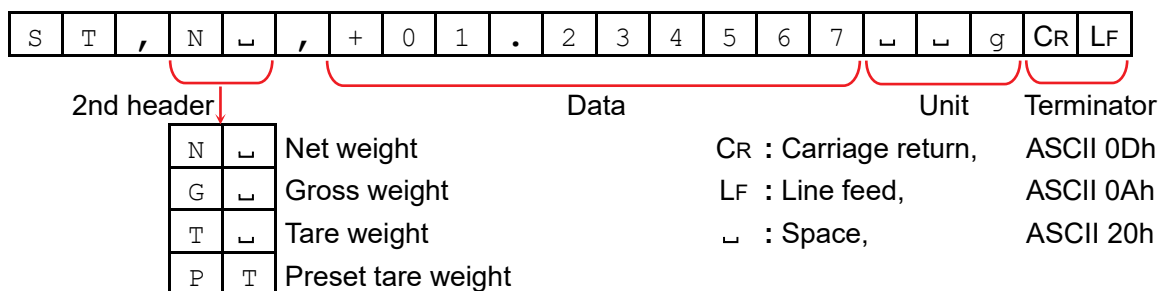

DP format (dump print)

RS-232C connection: Function table

S	F
---	---

 TYPE 1

USB connection: Function table

U5b

 U-EP 1

- This format is suitable for dump printing.
- Consists of 16 characters (not including the terminator).
- The condition of the data is indicated with a 2-character header.
- The polarity sign is added right before the value if it is not an overload or zero.
- The data is zero-suppressed (leading zeros are replaced with spaces).
- The unit consists of three characters.

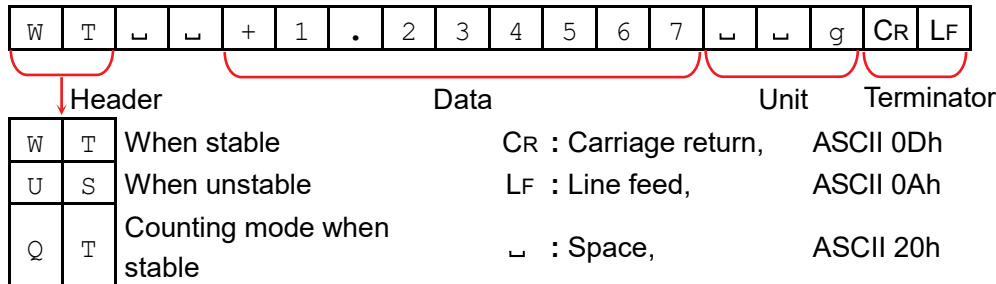

- If "Net/gross/tare output (NET)" is set to "1" to "3" in "data" of the function table, a header corresponding to the output data is added.

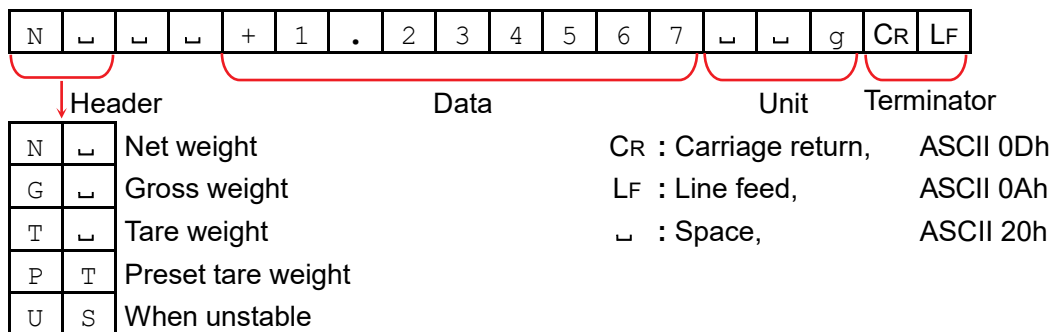

KF format

RS-232C connection: Function table

S	F
---	---

 TYPE 2

USB connection: Function table

U5b

 U-EP 2

- This is the Karl-Fischer moisture meter format.
- Consists of 14 characters (not including the terminator).
- There are no headers.
- The polarity sign is added to the first character if it is not an overload or zero.
- The data is zero-suppressed (leading zeros are replaced with spaces).
- When stable, the unit is output. When not stable, the unit is not output.

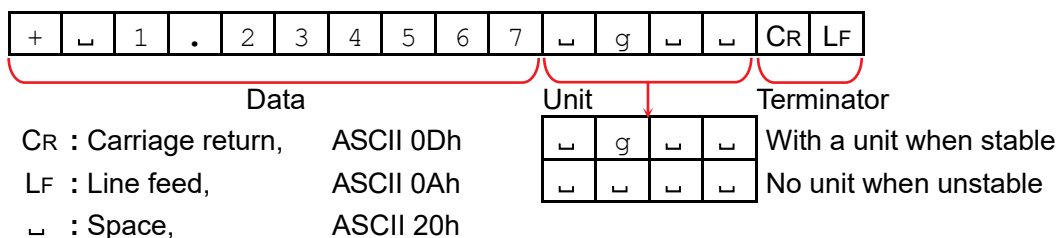

CSV format

RS-232C connection: Function table

S	T
---	---

 TYPE 6

USB connection: Function table

USb

 U-TP 6

- The data part and unit part of the A&D standard format are separated by a separator ",".
- Outputs the unit even when overloaded.
- When the decimal comma (,) is set, a semicolon (;) will be used instead as a separator.

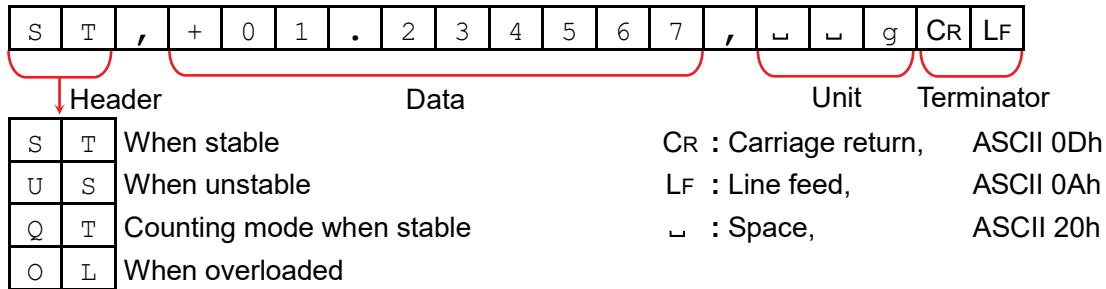

- If "Net/gross/tare output (Net)" is set to "1" to "3" in "data" of the function table, the second header corresponding to the output data is appended to the header.

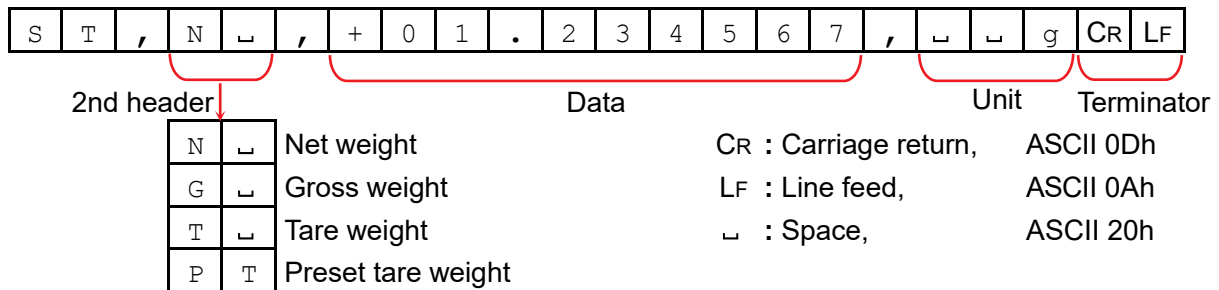

- When other data is added to the weighing value, all data will be output in one line.
The output sample will be as follows if the ID number, data number, date and time are added.

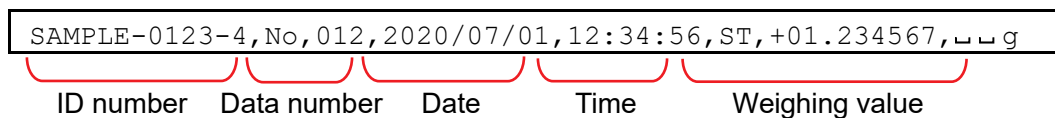

TAB format

RS-232C connection: Function table

S	T
---	---

 TYPE 7

USB connection: Function table

U	S	b
---	---	---

 U-EP 7

- This is a format, in which the separator of the CSV format is changed from comma to TAB.
- Used when connecting to a personal computer and inputting to Excel and the like.

S	T	TAB	+	0	1	.	2	3	4	5	6	7	TAB	␣	␣	g	CR	LF
Header		Data											Unit		Terminator			
S	T	When stable											CR	:	Carriage return,	ASCII 0Dh		
U	S	When unstable											LF	:	Line feed,	ASCII 0Ah		
Q	T	Counting mode when stable											␣	:	Space,	ASCII 20h		
O	L	When overloaded											TAB	:	Horizontal tab,	ASCII 09h		

UFC format

RS-232C connection: Function table

S	T
---	---

 TYPE 8

USB connection: Function table

U	S	b
---	---	---

 U-EP 8

- By using the Universal Flex Coms (UFC) function when outputting weighing data, desired contents can be output. Refer to "[23. UFC Function](#)" for more information.

20.3. Output examples of weighing data format

When stable

°	1	2	3	4	5	6	7	g
---	---	---	---	---	---	---	---	---

A&D	S	T	,	+	0	1	.	2	3	4	5	6	7	┐	┐	g	CR	LF
-----	---	---	---	---	---	---	---	---	---	---	---	---	---	---	---	---	----	----

DP	W	T	┐	┐	+	1	.	2	3	4	5	6	7	┐	┐	g	CR	LF
----	---	---	---	---	---	---	---	---	---	---	---	---	---	---	---	---	----	----

KF	+	┐	1	.	2	3	4	5	6	7	┐	g	┐	┐	CR	LF
----	---	---	---	---	---	---	---	---	---	---	---	---	---	---	----	----

MT	S	┐	┐	┐	1	.	2	3	4	5	6	7	┐	g	CR	LF
----	---	---	---	---	---	---	---	---	---	---	---	---	---	---	----	----

NU	+	0	1	.	2	3	4	5	6	7	CR	LF
----	---	---	---	---	---	---	---	---	---	---	----	----

NU2	1	.	2	3	4	5	6	7	CR	LF
-----	---	---	---	---	---	---	---	---	----	----

When unstable

-	0	0	1	2	3	4	5	g
---	---	---	---	---	---	---	---	---

A&D	U	S	,	-	0	0	.	0	1	2	3	4	5	┐	┐	g	CR	LF
-----	---	---	---	---	---	---	---	---	---	---	---	---	---	---	---	---	----	----

DP	W	T	┐	┐	-	0	.	0	1	2	3	4	5	┐	┐	g	CR	LF
----	---	---	---	---	---	---	---	---	---	---	---	---	---	---	---	---	----	----

KF	-	┐	0	.	0	1	2	3	4	5	┐	┐	┐	┐	CR	LF
----	---	---	---	---	---	---	---	---	---	---	---	---	---	---	----	----

MT	S	D	┐	-	0	.	0	1	2	3	4	5	┐	g	CR	LF
----	---	---	---	---	---	---	---	---	---	---	---	---	---	---	----	----

NU	-	0	0	.	0	1	2	3	4	5	CR	LF
----	---	---	---	---	---	---	---	---	---	---	----	----

NU2	-	0	.	0	1	2	3	4	5	CR	LF
-----	---	---	---	---	---	---	---	---	---	----	----

When overloaded (positive)

E	g
---	---

A&D	O	L	,	+	9	9	9	9	9	9	9	9	9	E	+	1	9	CR	LF
-----	---	---	---	---	---	---	---	---	---	---	---	---	---	---	---	---	---	----	----

DP	┐	┐	┐	┐	┐	┐	┐	┐	E	┐	┐	┐	┐	┐	┐	┐	CR	LF
----	---	---	---	---	---	---	---	---	---	---	---	---	---	---	---	---	----	----

KF	┐	┐	┐	┐	┐	┐	H	┐	┐	┐	┐	┐	┐	┐	CR	LF
----	---	---	---	---	---	---	---	---	---	---	---	---	---	---	----	----

MT	S	I	+	CR	LF
----	---	---	---	----	----

NU	+	9	9	9	9	9	9	9	9	CR	LF
----	---	---	---	---	---	---	---	---	---	----	----

NU2	+	9	9	9	9	9	9	9	9	CR	LF
-----	---	---	---	---	---	---	---	---	---	----	----

When overloaded (negative)

-E	g
----	---

A&D	O	L	,	-	9	9	9	9	9	9	9	9	9	E	+	1	9	CR	LF	
DP	␣	␣	␣	␣	␣	␣	␣	-	E	␣	␣	␣	␣	␣	␣	␣	␣	CR	LF	
KF	␣	␣	␣	␣	␣	␣	␣	L	␣	␣	␣	␣	␣	␣	␣	␣	␣	CR	LF	
MT	S	I	-	CR	LF															
NU	-	9	9	9	9	9	9	9	9	9	9	9	9	9	9	9	9	CR	LF	
NU2	-	9	9	9	9	9	9	9	9	9	9	9	9	9	9	9	9	CR	LF	

Unit code

Unit	A&D	DP	KF	MT			
g	␣	␣	g	␣	g		
mg	␣	m	g	␣	m	g	
<i>PCS</i>	␣	P	C	␣	P	C	S
%	␣	␣	%	␣	␣	%	
<i>ct</i>	␣	c	t	␣	c	t	
<i>mom</i>	m	o	m	␣	m	o	m

ASCII code and symbols

CR : Carriage return,	ASCII 0Dh
LF : Line feed,	ASCII 0Ah
␣ : Space,	ASCII 20h
TAB : Horizontal tab,	ASCII 09h

20.4. Other data formats

In addition to weighing data, various data can be added.

Change the ON/OFF of each setting in the function table as necessary.

ASCII code and symbols

CR: Carriage return, ASCII 0Dh ␣: Space, ASCII 20h
LF: Line feed, ASCII 0Ah

Data number

- To output, set "Data number (d -no)" to "Outputs data number (l)" in the function table.
- When the data memory function is used, the data number is output.
- Consists of 6 characters (not including the terminator).
- When the NU or NU2 format is selected with the Quick USB mode, only the decimal point "." and number are output.

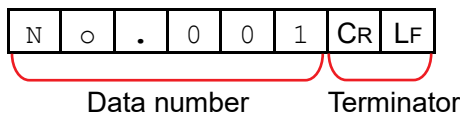

Quick USB connection (outputting the numerical values only)

- To output, set "USB function mode (U Fnc)" to "Quick USB (U)" and set "USB data format (U -tP)" to "NU format (4)" or "NU2 format (5)" in the function table.

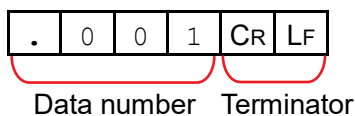

ID number

- To output, set "ID number (S -id)" to "Outputs ID number (l)" in the function table.
- The ID number stored in the balance is output.
- Consists of 13 characters (not including the terminator).
- When the NU or NU2 format is selected with the Quick USB mode, only the hyphen "-" and number are output.



Quick USB connection (outputting the numerical values only)

- To output, set "USB function mode (U Fnc)" to "Quick USB (U)" and set "USB data format (U -tP)" to "NU format (4)" or "NU2 format (5)" in the function table.

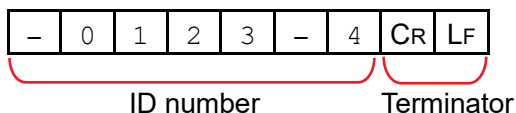

Date

- To output the date from the clock data of the balance, set "Time/Date (5-*t d*)" to "Outputs the date (2)" or "Outputs the time and date (3)" in the function table.
- The order of YYYY/MM/DD can be changed in the setting.
- Consists of 10 characters (not including the terminator).
- When the NU or NU2 format is selected with the Quick USB mode, "." is output instead of "/".

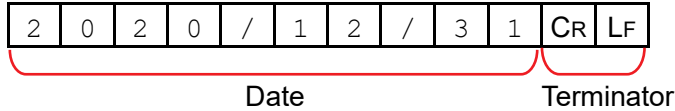

Quick USB connection (outputting the numerical values only)

- To output the date, set "USB function mode (*U F n c*)" to "Quick USB (0)" and set "USB data format (*U - t P*)" to "NU format (4)" or "NU2 format (5)" in the function table.

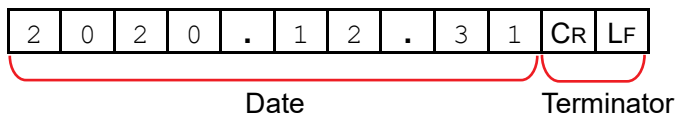

Time

- To output the time from the clock data of the balance, set "Time/Date (5-*t d*)" to "Outputs the time (1)" or "Outputs the time and date (3)" in the function table.
- 24-hour format.
- Consists of 10 characters (not including the terminator).
- When the NU or NU2 format is selected with the Quick USB mode, "." is output instead of ":".

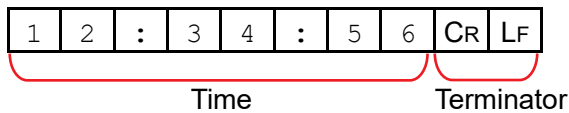

Quick USB connection (outputting the numerical values only)

- To output the time, set "USB function mode (*U F n c*)" to "Quick USB (0)" and set "USB data format (*U - t P*)" to "NU format (4)" or "NU2 format (5)" in the function table.

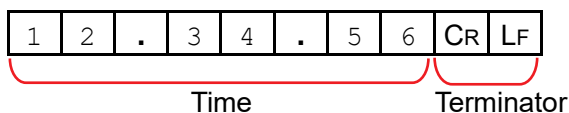

21. Commands

By sending the specified commands from a personal computer or a PLC to the balance, it is possible to control the balance to perform "weighing data request", "key operations", "setting value change", etc. To send a command to the balance, add a terminator to the command character string. You can set "CR LF" or "CR" in "Terminator ($\overline{E}rLF$)" of the function table.

ASCII code and symbols

CR:	Carriage return,	ASCII 0Dh	LF:	Line feed,	ASCII 0Ah
<ESC>:	Escape,	ASCII 1Bh	␣:	Space,	ASCII 20h

21.1. Control commands

Commands to query weighing data

Command	Function
Q	Requests the weighing data immediately
RW	Requests the weighing data immediately
SI	Requests the weighing data immediately
S	Requests the weighing data when stabilized.
<ESC>P	Requests the weighing data when stabilized.
SIR	Requests the weighing data continuously. (Stream output)
C	Cancels the S, <ESC>P, or SIR command.

- The Q, RW, and SI commands have the same function.
- The S, <ESC>, and P commands have the same function.

Key control commands

Command	Function
P	Same as the ON:OFF key.
ON	Turns the display on.
OFF	Turns the display off.
CAL	Same as the CAL key. Sensitivity adjustment with the internal weight.
EXC	Sensitivity adjustment with an external weight.
U	Same as the MODE key.
SMP	Same as the SAMPLE key.
PRT	Same as the PRINT key.
R	Same as the RE-ZERO key.
RZ	
T	Same as the TARE key.
TR	
ZR	Zero If the load is within $\pm 2\%$ of the capacity from the initial zero point, the zero point is updated, the tare value is cleared and the display is set to zero. If the load exceeds $\pm 2\%$, no processing is done.
RIR	Same as the IR sensor (right)
LIR	Same as the IR sensor (left)
TST	Performs calibration test with the internal weight.

- The R and RZ commands have the same function.
- The T and TR commands have the same function.

Commands to preset the tare value

Command	Function
PT:*.***** $\square\square$ g	Sets the preset tare value. Values exceeding the weighing capacity cannot be set. Negative values cannot be set. Add the unit in the A&D standard format (3 characters). If the display unit is PCS or percent (%), set the value in gram. In the case of setting the preset tare value to 1.23456 g, the input will be PT:1.23456 $\square\square$ g.
?PT	Requests the tare value. Outputs the tare value set with the PT, T, or TR command. The header when the preset tare value is set with the PT command is PT. The header when the tare value is set with the TARE key or the T or TR command is T \square .

Commands to control piece counting

Command	Function
UW:*.***** $\square\square$ g	Sets the unit weight value (weight of one piece). Values exceeding the weighing capacity cannot be set. Negative values cannot be set. Add the unit in the A&D standard format (3 characters). In the case of setting the unit weight value to 1.23 g, the input will be UW:1.23 $\square\square$ g.
?UW	Requests the unit weight value.

Commands to control the data memory function (Function table, *dRtR 1*)

dRtR 1 : Data memory, "Stores the unit weight".

Command	Function
UN:nn	Changes the unit weight registration number. Enter a number between 01 and 50 for nn.
?UN	Requests the currently selected unit weight registration number.

Commands to control the data memory function (Function table, *dRtR 2*)

dRtR 2 : Data memory, "Stores the weighing data/sensitivity adjustment history".

Command	Function
?MA	Requests all the stored weighing data.
?MQnnn	Requests the weighing data stored with the data number nnn. Enter a number from 001 to 200 for nnn.
?MX	Requests the number of stored data.
MD:nnn	Deletes the weighing data stored with the data number nnn. Enter a number from 001 to 200 for nnn.
MCL	Deletes all the stored weighing data.

Commands to set time and date

Command	Function
TM:**:**:**	Sets time. Do not set non-existing time values. In the case of setting time to "twelve thirty-four fifty-six seconds", the input will be TM:12:34:56.
DT:**/**/**	Sets date. Do not set non-existing date values. In the case of setting date to "January 23, 2020", the input will be DT:20/01/23.
?TM	Requests the time.
?DT	Requests the date.

Commands to request other data

Commands	Function
?T	Requests the tare value. Outputs the tare value set with the TARE key or the T or TR command.
?ID	Requests the ID number.
?SN	Requests the serial number.
?TN	Requests the device name.

21.2. <AK> code and error codes

When "AK (acknowledge), error code" is set to "On (Erld l)" in the function table, the balance always responds to reception of all commands sent from a personal computer or a PLC. Checking the code that is responded improves the reliability of the communication.

Balance response

- When the balance receives a command requesting data:
If the balance can output the data, it sends the requested data.
If the balance cannot output the data, it sends an error code (EC,Exx).
- When the balance receives a control command,
The balance will send an AK code (acknowledgment, ASCII 06h) upon confirmation of receipt of the command and completion of the process.
If the balance cannot execute the command, it sends an error code (EC, Exx).
- The following control commands have multiple responses from the balance during processing.
(Refer to the next page.)

An <AK> code (acknowledgement, ASCII 06h) will be sent when the command is confirmed and each process ends. If the balance cannot execute the command process, it sends an error code (EC,Exx). To clear the error, use the CAL command.

Command	Function
ON	Turns the display on.
P	Turns the display off. (Only when the display is on.)
R, RZ	Same as the RE-ZERO key.
T, TR	Same as the TARE key.
ZR	If the load is within $\pm 2\%$ of the weighing capacity from the initial zero point, the zero point is updated, the tare value is cleared and the display is set to zero. If the load exceeds $\pm 2\%$, no processing is done.
CAL	Sensitivity adjustment with the internal weight.
EXC	Sensitivity adjustment with an external weight.
TST	Performs calibration test with the internal weight.

21.3. Command usage examples

In the following examples, "AK, error code" is set to "On (ErEd l)" in the function table so that the balance outputs an <AK> code (acknowledgement, ASCII 06h) when it processes the command successfully.

ASCII code and symbols

CR: Carriage return, ASCII 0Dh

␣: Space, ASCII 20h

LF: Line feed, ASCII 0Ah

AK: Acknowledgement, ASCII 06h

Example of "ON command" (Turning the display on)

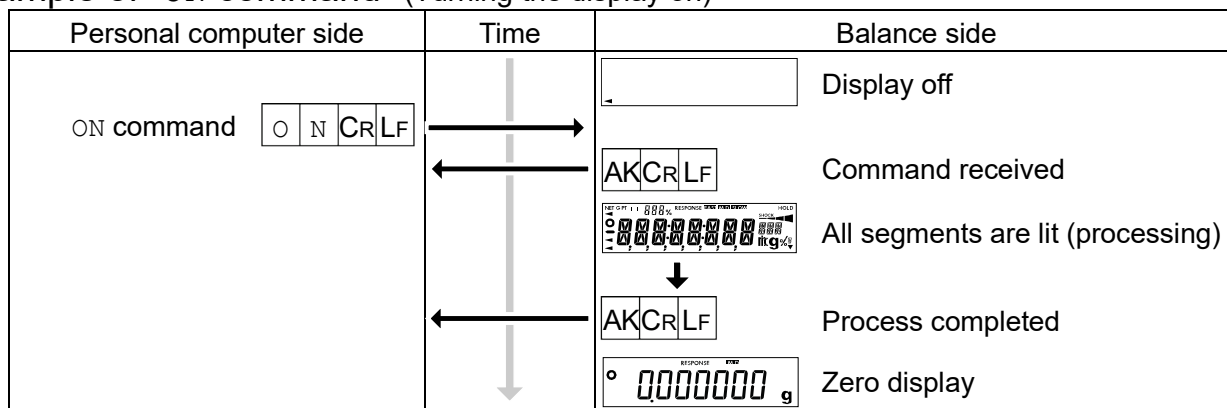

Example of "R command" (Same as the `RE-ZERO` key)

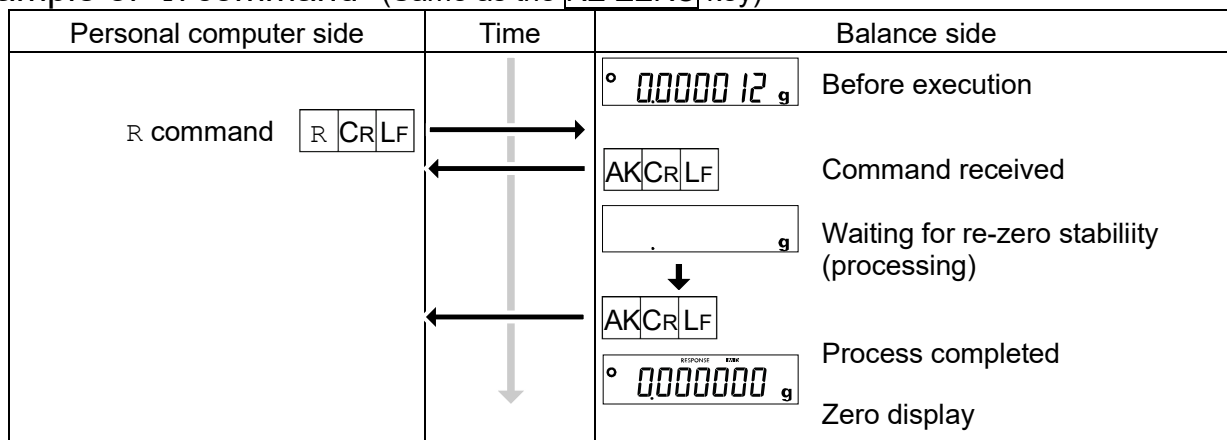

Example of "CAL command" (Sensitivity adjustment with the internal weight)

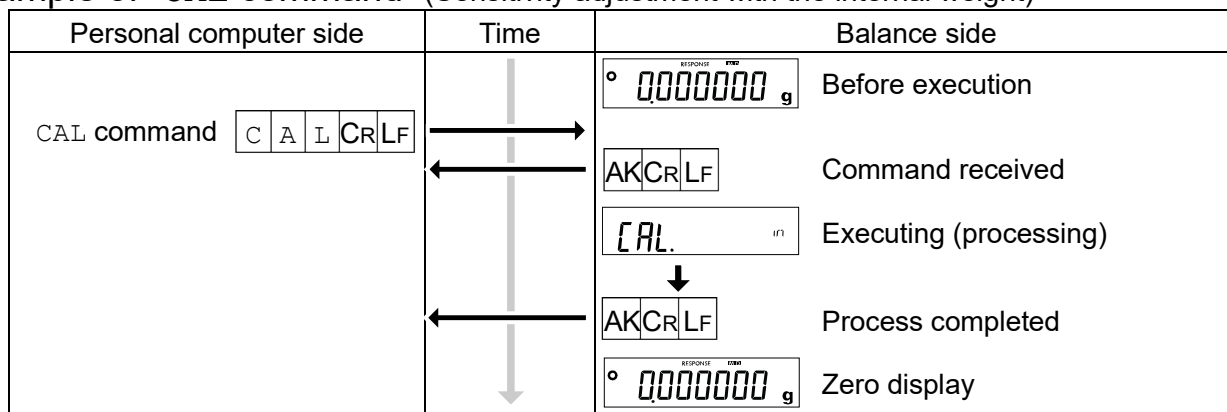

Example of error code output with “R command”

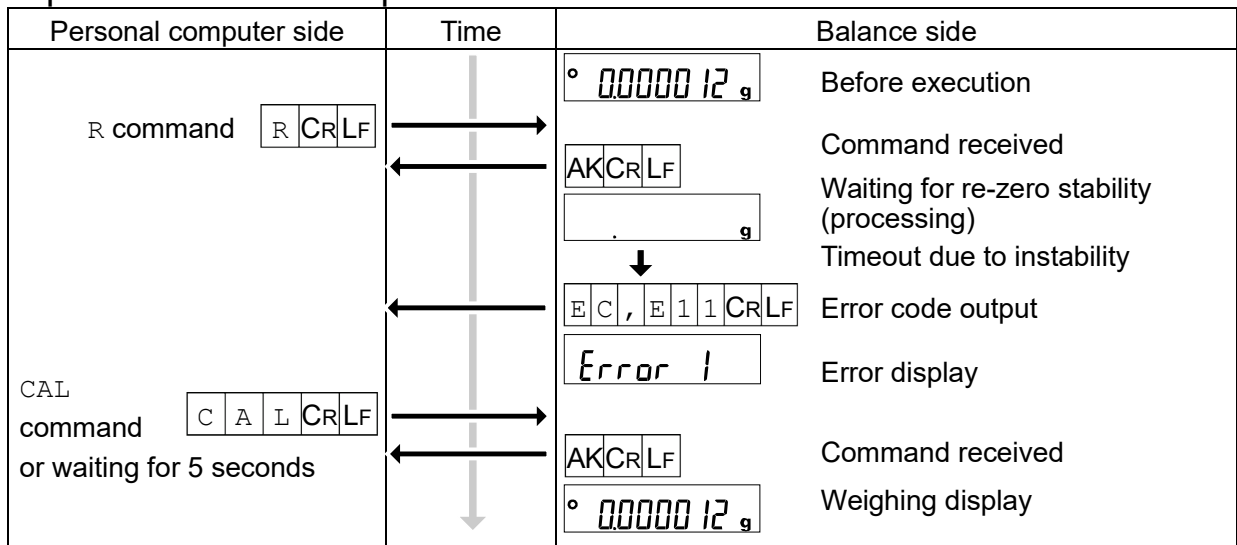



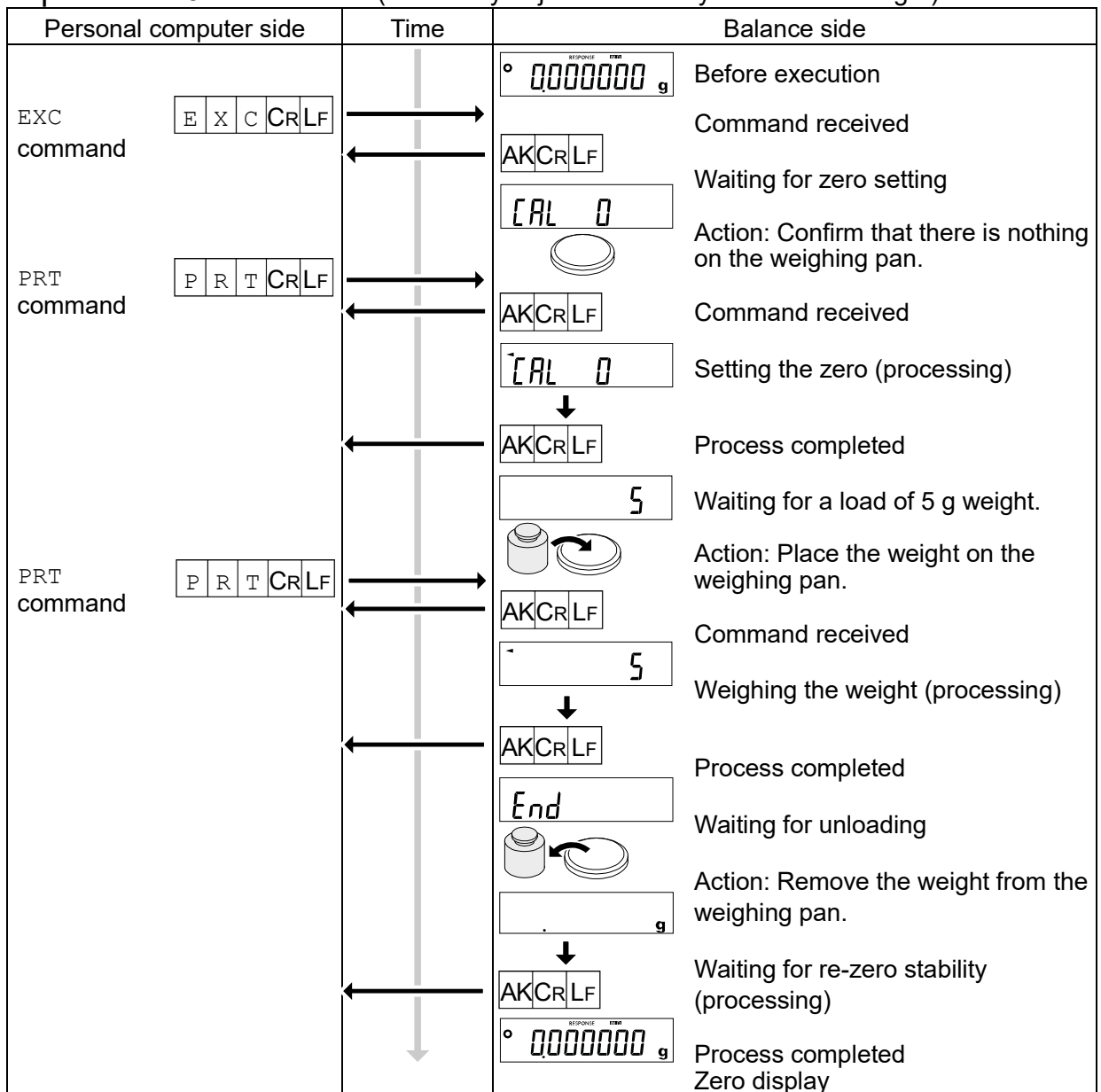



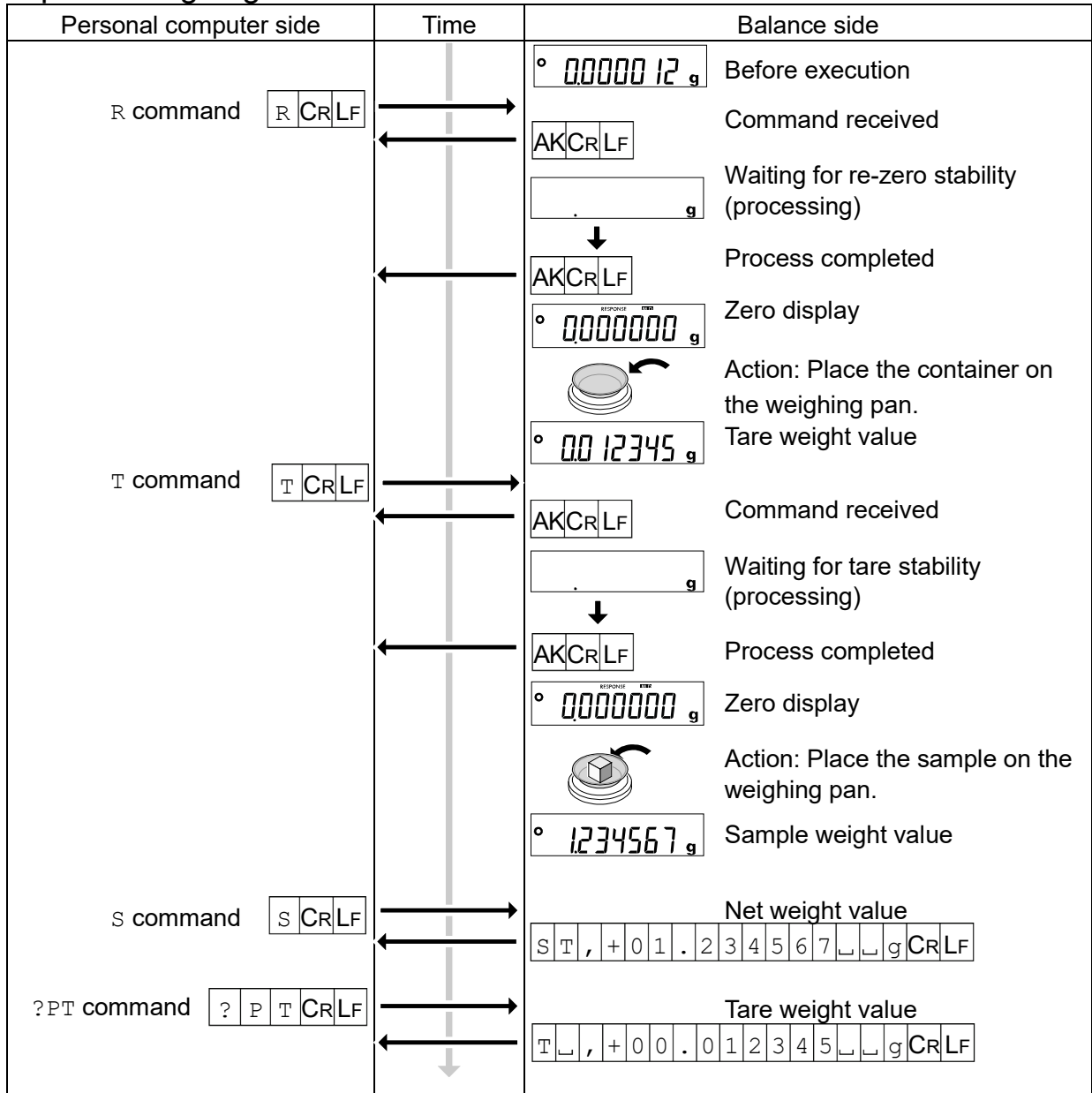



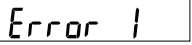

Example of “EXC command” (Sensitivity adjustment with your external weight)

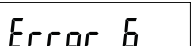

Example of weighing with tare function

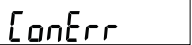
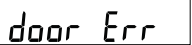
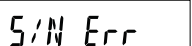
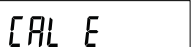

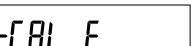
22. Error Displays (Error Codes)

Display	Code	Description and possible countermeasure
	EC,E11	<p>Stability error</p> <p>Weighing value is unstable and therefore the "zero display", "sensitivity adjustment", etc. cannot be executed. Check around the pan. Improve the environment of the installation location to prevent factors such as vibration, draft, and static electricity from influencing the balance. To clear the error and return to the weighing display, press the  key, send a CAL command, or wait for 5 seconds.</p>
		<p>Out of the setting range</p> <p>The value to be set exceeds the setting range. Set again within the setting range.</p>
		<p>Malfunction of the internal memory element of the balance</p> <p>If this error continues to be displayed, repair is necessary. Please contact your local dealer for repair.</p>
	EC,E16	<p>Internal weight error</p> <p>Applying the internal weight does not yield a change in the mass value as specified. Confirm that there is nothing on the pan and perform the operation from the beginning.</p>
	EC,E17	<p>Internal weight error</p> <p>The internal weight application mechanism does not function properly. Perform the operation from the beginning.</p>
 		<p>Abnormality in the internal memory data of the balance</p> <p>If this error continues to be displayed, repair is necessary. Please contact your local dealer for repair.</p>
		<p>Weighing unit error</p> <p>Data from the weighing unit has not been received. Check the connection between the weighing unit and the display unit, and turn the power off and then on again.</p>
		<p>Breeze break unit error</p> <p>Communication with the breeze break unit is not possible. Unplug the power supply and reconnect the cable between the breeze break unit and the weighing unit.</p>
		<p>Serial number error</p> <p>The serial numbers of the weighing unit and the display unit do not match. Reconnect with the correct combination.</p>
	EC,E20	<p>Sensitivity adjustment weight error (Positive value)</p> <p>The sensitivity adjustment weight is too heavy. Check around the pan. Check the mass value of the weight. To clear the error, press the  key, send a CAL command, or wait for five seconds.</p>
	EC,E21	<p>Sensitivity adjustment weight error (Negative value)</p> <p>The sensitivity adjustment weight is too light. Check around the pan. Check the mass value of the weight. To clear the error, press the  key, send a CAL command, or wait for five seconds.</p>

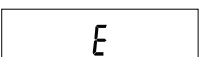
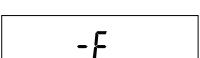
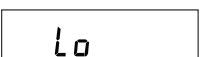
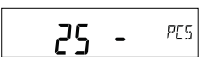
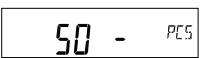
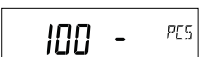
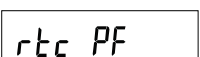
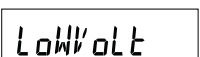
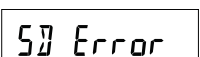
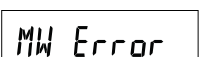
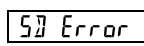
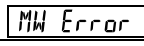
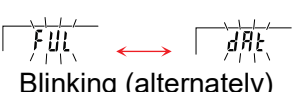
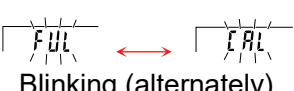
Display	Code	Description and possible countermeasure
		Overload error A sample beyond the balance weighing capacity has been placed on the weighing pan. Remove the object from the weighing pan.
		Weighing pan error The weighing value is too light. Check that the weighing pan is installed correctly. Set the weighing pan correctly. Perform sensitivity adjustment.
		Sample mass error The sample is too light to be stored as a sample mass for the counting mode or percent mode. The sample cannot be used.
  		Unit weight error The sample mass for the counting mode is too light. Storing and using it for counting may cause a counting error. Add samples to reach the specified number and press the PRINT key. Although pressing the PRINT key without adding samples will put the balance in counting mode, make sure to add samples for accurate counting.
		Clock battery error The clock backup battery has been depleted. Press any key and set the time and date. Even if the clock backup battery is depleted, the clock and calendar function works normally as long as the balance is powered with the AC adapter. If this error appears frequently, contact your local dealer for repair.
		Power supply voltage fault The voltage supplied from the AC adapter is abnormal. Check that the AC adapter is the one supplied with the balance.
 		Repeatability error The standard deviation (SD) of repeatability exceeded 50 d. Review the installation environment of the balance.  in repeatability display.  in minimum weighing value (reference value) display.
 Blinking (alternately)		Full memory The number of stored weighing values has reached the upper limit. In order to store a new weighing value, it is necessary to delete data. For details, refer to " 10. Data Memory ".
 Blinking (alternately)		Full memory The stored sensitivity adjustment/calibration test history has reached 50 results. In order to store a new result, the oldest history will be deleted. For details, refer to " 10. Data Memory ".
	EC,E00	Communications error A protocol error occurred in communications. Check the format, baud rate, etc.
	EC,E01	Undefined command error An undefined command was found. Check the transmitted command.

Display	Code	Description and possible countermeasure
	EC,E02	<p>Not ready</p> <p>The received command cannot be executed: (e.g.) Q command was received when not in weighing mode. (e.g.) Q command was received while re-zeroing. Adjust the delay time to transmit a command.</p>
	EC,E03	<p>Timeout error</p> <p>With the timeout parameter set to <input 1=""],="" a="" approximately="" characters.="" check="" command="" communication.<="" more="" of="" or="" p="" receiving="" second="" the="" there="" time="" type="text" value="t-UP 1" wait="" was="" while=""/> </p>
	EC,E04	<p>Character length error</p> <p>The number of characters in the received command has exceeded the limit. Check the command to transmit.</p>
	EC,E06	<p>Format error</p> <p>The description of the received command is incorrect: (e.g.) The number of digits of numerical values is incorrect. (e.g.) There are alphabet characters among the numerical values. Check the transmitted command.</p>
	EC,E07	<p>Parameter setting error</p> <p>The value of the received command has exceeded the allowed value. Check the setting range of the numerical value of the command.</p>

23. UFC Function

- The UFC (Universal Flex Coms) function allows you to output contents of your choice when outputting the weighing data. You can also output a character string when printing a barcode with a label printer or the like.
- In order to use the UFC function, it is necessary to set "Data format" to "UFC format (TYPE B)" or "USB data format" to "UFC format (U-TP B)" in the function table.

23.1. UFC program commands

The desired output format can be stored in the balance by sending the program command from the personal computer. The stored output format is saved even when the balance is powered off.

Creating program commands

- The maximum number of characters for a program command is 254 characters.
- Add the "PF," command at the beginning.
- Program commands are combined using comma or space delimiters, which can be omitted to reduce the number of characters. The comma after the "PF," command, however, cannot be omitted.

Program command list

Command	Function	Output example
PF,	FC command header Added to the beginning of the program command.	
\$MN	Manufacturer name	□□□□□□□□ A □ & □ D
\$TY	Model name	□□□□□□□□□□ B A - 6
\$SN	Serial number	□□□□□ T 1 2 3 4 5 6 7
\$ID	ID number	S A M P L E - 1 2 3 4 - 5
\$DT	Date	2 0 2 0 / 1 2 / 0 1
\$TM	Time	1 2 : 3 4 : 5 6
\$WT	Weighing data	□□ + 0 . 2 3 4 5 6 7 □□ g
\$GR	Gross data (gross weight)	□□ + 1 . 2 3 4 5 6 7 □□ g
\$NT	Net data (net weight)	□□ + 0 . 2 3 4 5 6 7 □□ g
\$TR	Tare data (tare weight)	□□ + 1 . 0 0 0 0 0 0 □□ g
\$PC	Counting data	□□□□□□ + 1 2 3 4 □ P C
\$UW	Unit weight data	□□□□□□ + 0 . 1 2 □□ g
\$CM	Comma	,
\$SP	Space, ASCII 20h	□
\$CR	Carriage return, ASCII 0Dh	CR
\$LF	Line feed, ASCII 0Ah	LF

- Enclose an ASCII code string in single quotation marks. Character strings that can be output are comprised of alphanumeric characters and symbols. The single quotation mark is represented by

two single quotation marks.

Example. Character string for outputting A'BC'D is 'A' 'BC' 'D' .

- To output the ASCII control code, enter "# + 2 hexadecimal characters".

Example. To output the ASCII code "End of Transmission, EOT (04h)", enter #04.

- By adding '* and a number (up to 2 characters)' after the command, space (\$SP), CR (\$CR), and LF (\$LF) can be repeated as many times as the number entered.

Example. To output 12 spaces, enter \$SP*12.

To output 9 CRs, enter \$CR*9.

- By adding '&' to the end of a line when sending two or more lines of program command, the balance determines that the program command will continue on the next line. (RS-232C only)
- The balance will send an <AK> code (acknowledgement, ASCII 06h) upon confirmation of receipt of the program command and completion of the process. If the command cannot be executed, an error code (EC, Exx) will be sent.
- The software "Windows Communication Tools for UFC" ("WinCT-UFC") for creating program commands is available.
Download "WinCT-UFC" from our website <https://www.aandd.jp>.

23.1.1. Examples of UFC program command creation

Note See the previous page for the meanings of UFC commands and symbols.
For the data output format, refer to "20. Data Output".

Example 1

Output	Contents	Program command example
NET	Character string 'NET', Line feed	PF, 'NET', \$CR, \$LF, &
+++++0.234567++g	Space×4, Net data, Line feed	\$SP*4, \$NT, \$CR, \$LF, &
TARE	Character string 'TARE', Line feed	'TARE', \$CR, \$LF, &
+++++1.000000++g	Space×4, Tare data, Line feed	\$SP*4, \$TR, \$CR, \$LF, &
GROSS	Character string 'GROSS', Line feed	'GROSS', \$CR, \$LF, &
+++++1.234567++g	Space×4, Gross data	\$SP*4, \$GR, \$CR, \$LF
		Terminator

Example 2

Output	Contents	Program command example
2020/09/01 12:34:56	Date, Time, Line feed	PF, \$DT, \$TM, \$CR, \$LF, &
SAMPLE++++++ABC-123	Character string 'SAMPLE++++++ABC-	'SAMPLE++++++ABC-123', \$CR, \$LF, &
WEIGHT+++++2.345678++g	123', Line feed	'WEIGHT+++++', \$WT, \$CR, \$LF
	Character string 'WEIGHT+++++',	Terminator
	Weight data	

24. Key Lock Function

The key switches of the balance can be locked by sending a specified command to the balance. This is a useful function when you want to control the balance only with an external device such as a personal computer.

- Even in the key lock state, it is possible to operate the keys with the key control commands. For the key control commands, refer to "21. Commands".
- Key lock state can be checked by sending a command to check the state to the balance.
- Key lock is maintained until either a command is sent to the balance to release or the power is turned off by unplugging the AC adapter.

24.1. Locking all key switches

All the key switches of the balance can be disabled by sending a **KL** command to the balance.

Command string	Function
?KL	Requests all keys lock state KL,000 All keys unlocked. KL,001 All keys locked.
KL:***	In place of ***, 000 or 001 is entered. KL:000 All keys unlocked. KL:001 All keys lock set.

24.2. Locking a specified key switch

Any key switches can be enabled/disabled by the numerical value **** specified by the **LK** command.

The numerical value **** is the total of the decimal numbers converted from the bit value assigned for each key switch as shown below.

Bit	Decimal number	Key switches
0	1	ON:OFF key
1	2	CAL key
2	4	MODE key
3	8	SAMPLE key
4	16	PRINT key
5	32	TARE key
6	64	RE-ZERO key
7	128	IR sensor (left)
8	256	IR sensor (right)

Example1. To lock the key switches other than the **PRINT** key, add the decimal numbers corresponding to the keys to be locked.

ON:OFF key	1 × 1 (Lock)	+
CAL key	2 × 1 (Lock)	+
MODE key	4 × 1 (Lock)	+
SAMPLE key	8 × 1 (Lock)	+
PRINT key	16 × 0 (Unlock)	+
TARE key	32 × 1 (Lock)	+
RE-ZERO key	64 × 1 (Lock)	+
IR sensor (left)	128 × 1 (Lock)	+
IR sensor (right)	256 × 1 (Lock)	= 495

Command string	Function
?LK	Requests the status of the specified key locks. Example 1. When the key switches other than the PRINT key are locked. LK, 00495 Example 2. When all key switches are unlocked. LK, 00000
LK:*****	Locks the specified keys. A number from 00000 to 00511 is entered in place of *****. Sends the LK: command to the balance. Example 1. Locks the key switches other than the PRINT key. LK:00495 Example 2. Unlocks all key switches. LK:00000

25. Maintenance

25.1. Treatment of the balance

- When cleaning the balance, wipe it with a lint free cloth that is moistened with a little neutral detergent.
- Do not use organic solvents or chemical cleaning cloths to clean the balance.
- Do not disassemble the balance.
- When transporting the balance, use the packing material and box that the balance was contained at the time of purchase.

For transportation, remove the following parts from the balance main body:

Weighing pan parts (weighing pan, pan support, dust plate, breeze break ring, breeze break bottom plate)

Small glass breeze break parts (side panes (3), top pane, base stand)

Breeze break front glass, breeze break doors, breeze break top door, attached cables)

26. Troubleshooting

26.1. Checking the balance performance and environment

- Since the balance is a precision instrument, in some cases it may not be able to measure correct values due to adverse effects of the measurement environment or measurement method. If repeatability is poor when the sample is loaded and unloaded several times, or if the balance seems to be operating abnormally, check the following items. If the problem persists after checking each item, contact your local A&D dealer for repair. "Frequently Asked Questions" and answers to them are also posted on our website (<https://www.aandd.jp>).

1. Checking that the balance works properly.

Method 1. As a simpler test, check the repeatability with an external weight. Be sure to place the weight in the center of the weighing pan.

Method 2. As a precise test, check the repeatability, linearity, weighing value, etc. with a weight of a known weight.

2. Checking that the measurement environment and method are appropriate.

Check the following check items.

Operating environment

- Is the table on which the balance is placed sturdy? (Specifically for BA-6E/BA-6DE)
- Is the balance level? For how to adjust the bubble spirit level, refer to "[2.4 Precautions during use for more accurate weighing](#)".
- Is the operating environment free from vibration and drafts?
- Is there any strong electrical or magnetic noise source such as a motor near the balance?

Weighing method

- Is the weighing pan set so that it does not touch other parts such as the breeze break and dust plate frame? (Is it installed correctly?)
- Do you always press the **RE-ZERO** key before placing your sample on the weighing pan?
- Do you place your sample in the center of the weighing pan?
- Did you perform a sensitivity adjustment before weighing?
- Did you warm up the balance before weighing for at least an hour with the AC adapter connected to the power supply?

Sample and container

- Is the sample free from moisture absorption or evaporation due to the influence of ambient temperature and humidity?
- Is the temperature of the container of the sample acclimatized to the ambient temperature? Refer to "[2.4 Precautions during use for more accurate weighing](#)".
- Is the sample free of static electricity? Refer to "[2.4 Precautions during use for more accurate weighing](#)". The sample may be charged with static electricity especially with the BA-6E/BA-6DE when the relative humidity is low.
- Is the sample a magnetic material (iron, etc.)? Care must be taken when weighing magnetic materials. Refer to "[2.4 Precautions during use for more accurate weighing](#)".

26.2. Other display



The automatic sensitivity adjustment notice (the ◀ indicator blinking) indicates that the automatic sensitivity adjustment will start.

If the balance is not used for a certain period of time with this indicator blinking, the balance automatically performs sensitivity adjustment using the internal weight. (The blinking period depends on the operating environment.)

Tips

Although it is possible to continue using the balance even while this mark is blinking, use after sensitivity adjustment is completed is advisable in order to maintain the weighing accuracy.

26.3. Asking for repair

If the balance needs service or repair, contact your local A&D dealer.

The balance is a precision instrument. Use much care when handling the balance when transporting the balance.

Use the packing material and box that the balance was contained in at the time of purchase.

Remove the weighing pan and pan support from the main unit of the balance.

27. Checking the Software Version of the Balance

Specifications may vary depending on the balance software version.
Check the software version as follows.

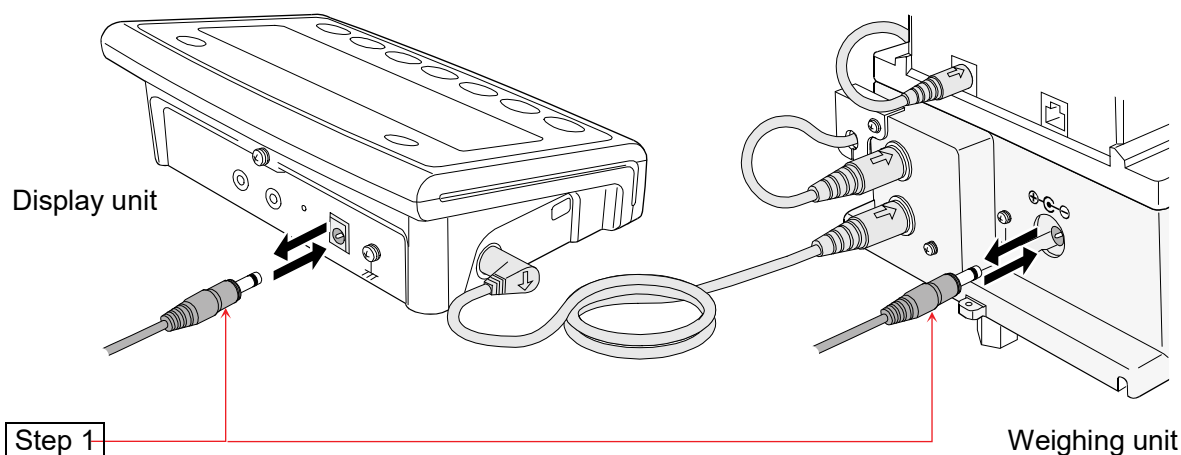

Step 1. Reconnect the AC adapter of the weighing unit or display unit.

Step 2. `Connect` displays blinking.

Step 3. `P-*.***` is displayed.

In place of `*.***`, the software version is displayed.

The indicator for the display unit/weighing unit/breeze break unit is displayed at the upper left.

Display unit `dSP`

Weighing unit `bRL`

Breeze break unit (It is hidden if not connected) `bb`

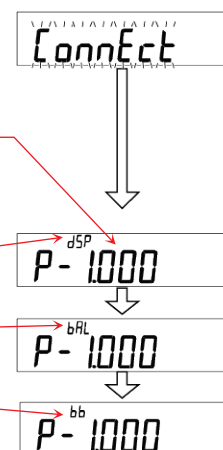

28. Ionizer (AX-ION-25)

The AX-ION-25 ionizer comes standard with the BA-6E/BA-6DE.

The ionizer removes static electricity by irradiating the target object with positive or negative ions, which are generated from four discharge electrodes by DC corona discharge. Ordinarily, insulators such as powders, filters, and weighing paper, tend to be charged when the humidity is 45% RH or less, and an error of a few milligrams may occur during weighing. By removing static from the weighing object with the ionizer, it is possible to eliminate the error in the weighing value due to charging, and correct weighing can be performed.

28.1. Usage

- Step 1. Make sure that the AC adapter of the balance is not connected, and then connect the balance and the ionizer (as noted in "2.2 Assembly and installation").
- Step 2. Connect the AC adapter, plug it in, and then turn on the power. The power lamp of the ionizer lights up.
- Step 3. Place the target object within the effective range of static elimination.
- Step 4. Hold your hand over the IR sensor (touchless infrared proximity sensor) on the front of the ionizer to start static elimination. The ION lamp indicating that static elimination is in progress lights up.
- Step 5. Refer to the figure below for the effective range of static elimination, and perform static elimination. At factory setting, when three seconds have passed from the start of static elimination, the ION lamp indicating that static elimination is in progress turns off and static elimination stops.

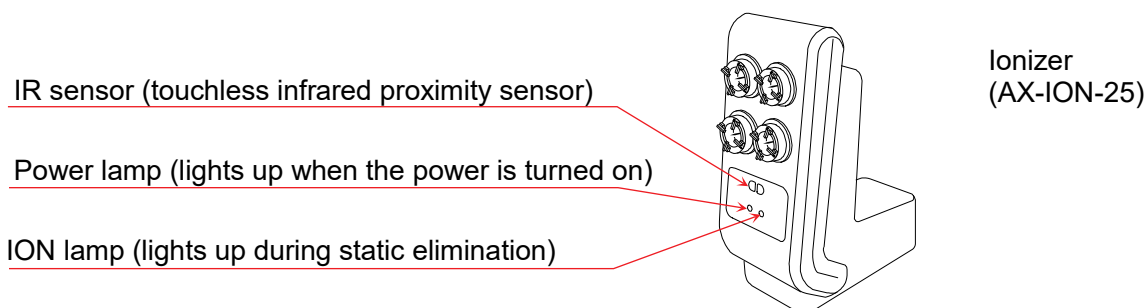

Effective range of static elimination

Top view

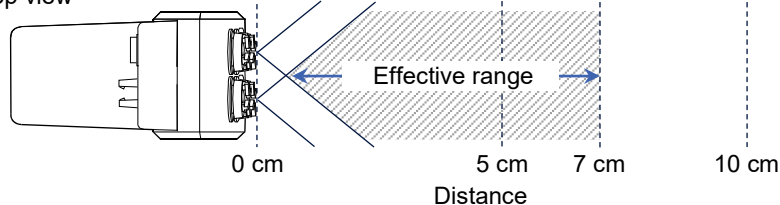

Side view

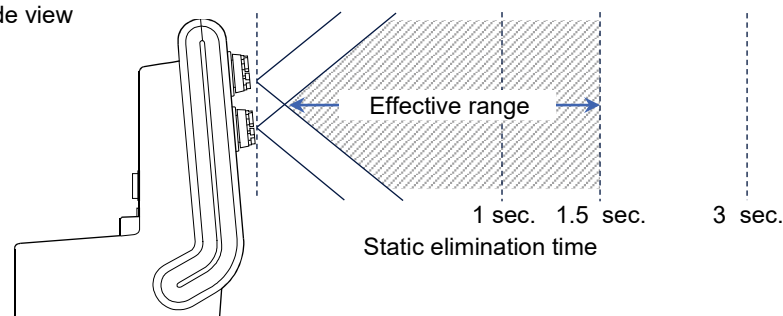

28.2. Maintaining the ionizer

Caution: Do not touch electrode units while the ionizer is in operation. Doing so may result in electric shock.

- Dust and other substances adhere to the electrode needle area of the ionizer over time, degrading the static elimination capacity. To maintain the performance, clean the electrode needle on electrode units with a dry cotton swab, etc. on a regular basis.
- If the static elimination capacity does not recover because the tip of the electrode needle on an electrode unit is worn out, replace all of the four electrode units with new ones. The lifetime of electrode units is approx. 10000 hours.

Replacement procedure

Step 1. Disconnect the balance connection cable and turn off the power.

Step 2. Rotate electrode units counterclockwise by 45° to pull them out.

Step 3. Insert new electrode units and rotate them clockwise by 45° to secure them.

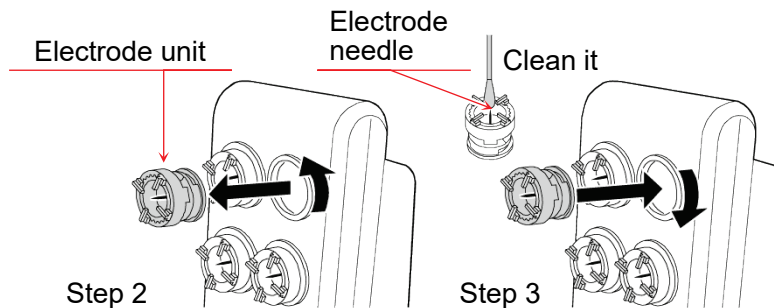

29. Specifications

29.1. Common specifications

29.1.1. Function

Internal weight		BA-6E, BA-6DE: approx. 5 g BA-225, BA-225D, BA-125D: approx. 100 g	*1
Ionizer (static eliminator)		Detached type	*2
Sensitivity drift (10 °C to 30 °C)		±2 ppm/°C (Automatic sensitivity adjustment OFF)	
Operating environment		5 °C to 40 °C, 85%RH or less (no condensation)	
Operation		Key switches	
Display		Liquid crystal display (monochrome)	
Display refresh rate		5 times/second or 10 times/second	
Counting mode	Number of samples	10, 25, 50 or 100 pieces	
Percent mode	Readability	0.01%, 0.1%, 1% (Automatically changed by 100% reference mass)	
Communication		RS-232C (printer, PLC, etc.), USB Type B (PC), Stereo jack (external switch) x 2	
Power (AC adapter)		Confirm that the adapter type is correct for the local voltage and power receptacle type. Power consumption: Approx. 36 VA (including the AC adapter)	

*1 The internal weight may change in mass due to the usage environment and deterioration over time.

*2 Comes standard with the BA-6E/BA-6DE.

29.1.2. Size/Weight

		BA-6E、BA-6DE	BA-225	BA-225D	BA-125D
Weighing pan size		φ25	φ85		
Main body weight		6.6 kg *3	6.7 kg *4		
External dimensions	Display unit	182 (W) x 138 (D) x 73 (H) mm			
	Weighing unit and breeze break unit	173 (W) x 305 (D) x 204 (H) mm	173 (W) x 305 (D) x 284 (H) mm		
	Ionizer	68 (W) x 129 (D) x 162 (H) mm	-		

*3 The combined weight of the display unit, weighing and breeze break units, and ionizer.

*4 The combined weight of the display unit and weighing and breeze break units.

29.2. Individual Specifications

	BA-6E	BA-6DE
Capacity	6.2 g	6.2 g
		2.1 g
Maximum display	6.200084 g	6.20008 g
		2.100009 g
Readability	0.001 mg	0.01 mg
		0.001 mg
Repeatability Standard deviation (measuring point)	0.0010 mg (1 g)	0.01 mg (6 g)
	0.0030 mg (6 g)	0.0025 mg (1 g)
Linearity	±0.010 mg	±0.02 mg
		±0.010 mg
Stabilization time FAST setting, good environment	Approx. 10 seconds	Approx. 10 seconds
		Approx. 10 seconds
Counting mode Minimum unit weight	0.1 mg	
Percent mode Minimum 100% reference mass	10.0 mg	
Applicable weights for calibration test/sensitivity adjustment	5 g (factory setting) 2 g 1 g	

	BA-225	BA-225D	BA-125D
Capacity	220 g	220 g	120 g
		51 g	51 g
Maximum display	220.00084 g	220.0008 g	120.0008 g
		51.00009 g	51.00009 g
Readability	0.01 mg	0.1 mg	0.1 mg
		0.01 mg	0.01 mg
Repeatability Standard deviation (Measurement point)	0.015 mg (50 g)	0.1 mg (200 g)	0.1 mg (100 g)
	0.03 mg (200 g)	0.025 mg (50 g)	0.030 mg (50 g)
Linearity	±0.15 mg	±0.2 mg	±0.2 mg
Stabilization time FAST setting, good environment	Approx. 7 seconds	Approx. 7 seconds	Approx. 7 seconds
		Approx. 7 seconds	Approx. 7 seconds
Counting mode Minimum unit weight	0.1 mg		
Percent mode Minimum 100% reference mass	10.0 mg		
Applicable weights for calibration test/sensitivity adjustment	200 g (factory setting) 100 g 50 g 20 g 10 g	100 g (factory setting) 50 g 20 g 10 g	

29.3. External dimensions

(Unit: mm)

Display unit

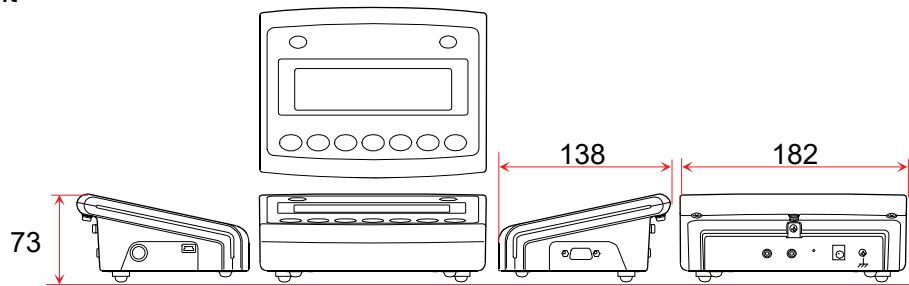

Weighing unit/breeze break unit/ionizer for BA-6E/BA-6DE

	A: Weighing pan diameter	B: Height to the weighing pan	C: Height above the weighing pan
BA-6E / BA-6DE	φ25	118	47
BA-225 / BA-225D / BA-125D	φ85	119	149

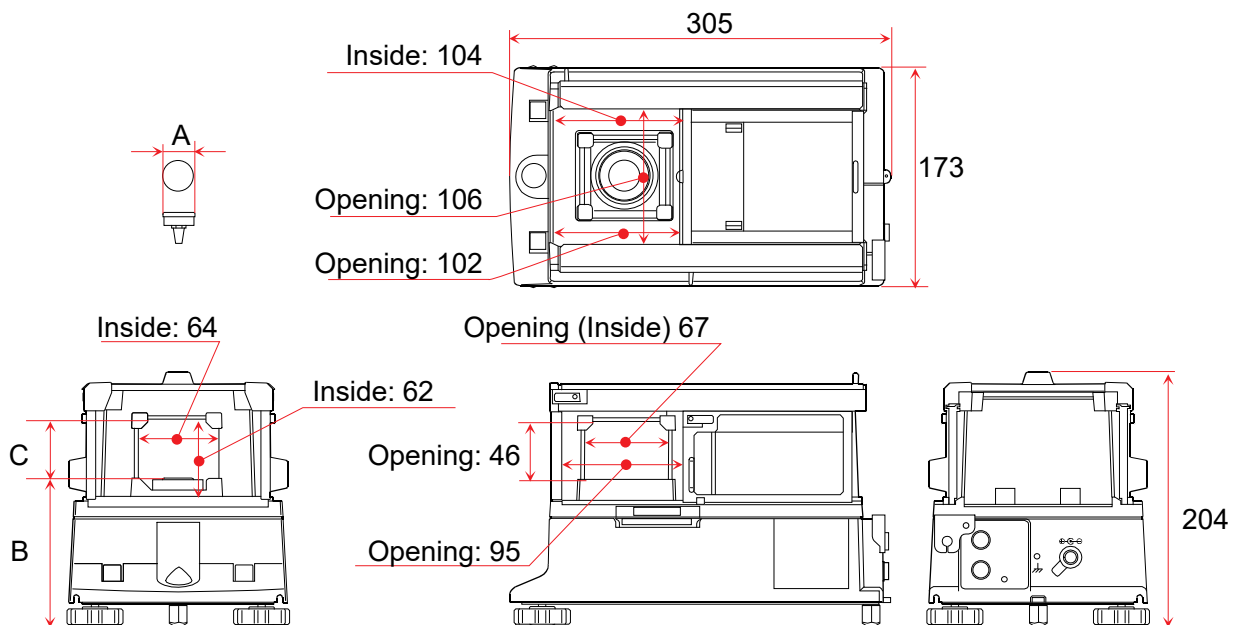

Ionizer (AX-ION-25)

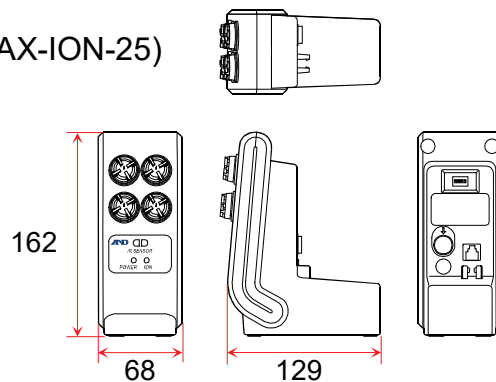

Weighing unit/breeze break unit for BA-225/BA-225D/BA-125D

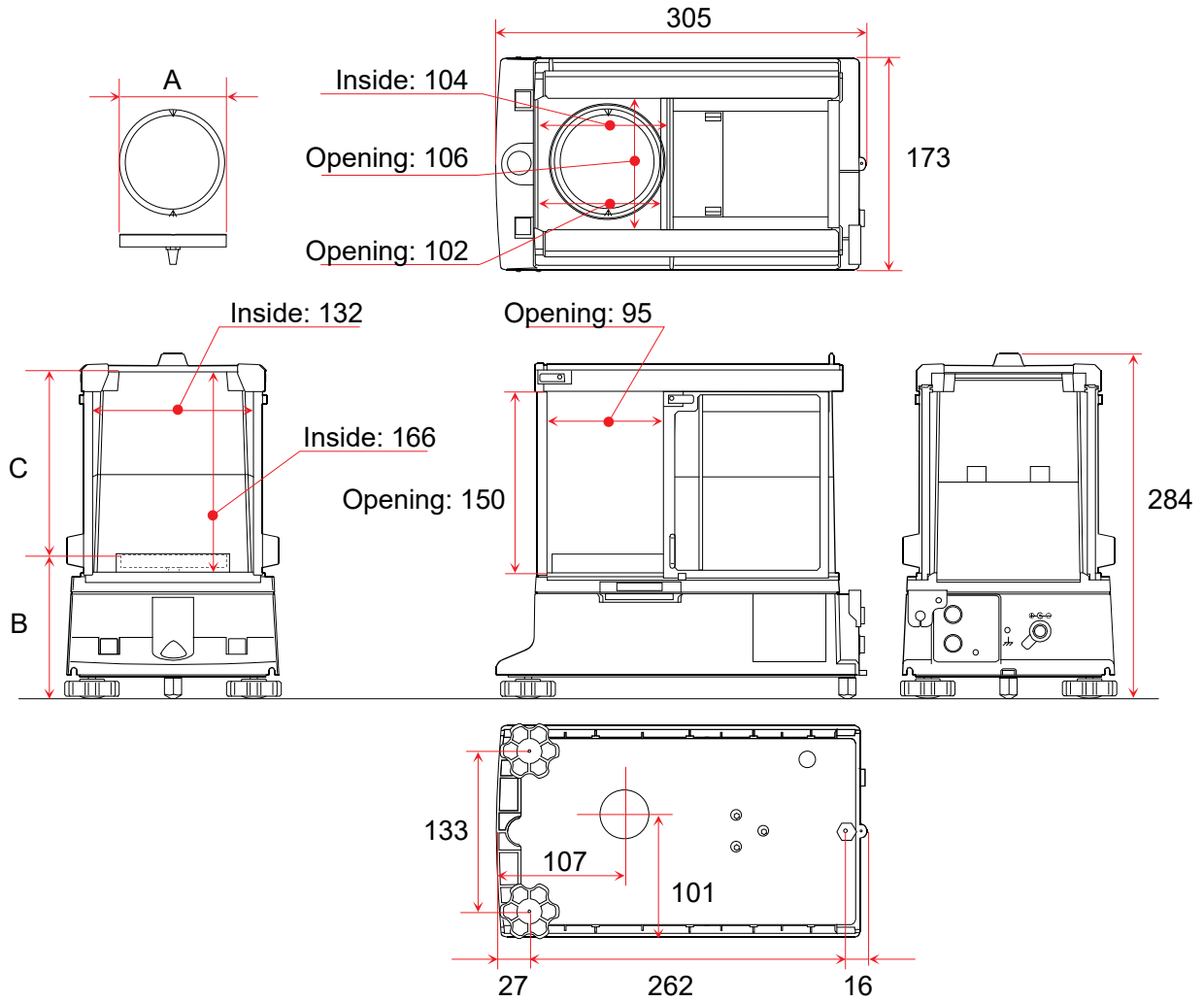

29.4. Peripherals

AD-8127: Compact printer

- Small dot impact printer that connects with the balance via the RS-232C interface.
- Receives and prints data output from the balance in dump printing mode.

AD-1687: Weighing environment logger

- A data logger equipped with four sensors for temperature, humidity, barometric pressure and vibration that can measure and store environmental data
- When connected to the RS-232C interface of the balance, the AD-1687 can store environmental data along with weighing data.

AD-1688: Weighing data logger

- When connected to the RS-232C interface of the balance, the AD-1688 can store the data.
- Convenient for recording data in places where a personal computer cannot be used.

AD-1689: Tweezers for sensitivity adjustment weight

- A pair of tweezers ideally suited for holding sensitivity adjustment weights of 1 g to 500 g.

AX-USB-9P: USB converter

- Converts the balance's RS-232C interface to USB.
- Driver installation is required.

AD-8529PC-W: Bluetooth® converter (for a personal computer connection)

- Enables wireless communication between a balance and a personal computer via Bluetooth® up to 10 m.
- Driver installation is required.

AD-8529PR-W: Bluetooth® converter (for a printer connection)

- Enables wireless communication between a balance and a printer via Bluetooth® up to 10 m.

AX-SW137-PRINT: Foot switch for PRINT (with connector)

- Foot switch that functions in the same way as the **PRINT** key.

AX-SW137-REZERO: Foot switch for RE-ZERO (with connector)

- Foot switch that functions in the same way as the **RE-ZERO** key

AX-ION-25: External ionizer

- Detached type ionizer.
The instruction manual can be downloaded from our website <https://www.aandd.jp>.

AX-BM-NEEDLESET: Discharge electrode units for the ionizer (a set of 4 pcs)



- Electrode replacement unit for the ionizer.
When replacing, replace the four pieces at the same time.
The instruction manual can be downloaded from our website <https://www.aandd.jp>.

AX-IR-SWITCH: IR switch

- An IR switch to connect to the ionizer.

Aluminum analytical pans

- Sample containers for measuring minute amounts.

Item name	Description	Item code	Shape
Aluminum analytical pans (large)	φ15, 0.8 mL, 100 pcs	AX-ROUND-PAN-L	
Aluminum analytical pans (medium)	φ12, 0.3 mL, 100 pcs	AX-ROUND-PAN-M	
Aluminum analytical pans (small)	φ8, 0.05 mL, 100 pcs	AX-ROUND-PAN-S	



A&D Company Limited

3-23-14 Higashi-Ikebukuro, Toshima-ku, Tokyo 170-0013, JAPAN
Telephone: [81] (3) 5391-6132 Fax: [81] (3) 5391-1566

A&D ENGINEERING, INC.

1756 Automation Parkway, San Jose, California 95131, U.S.A.
Telephone: [1] (408) 263-5333 Fax: [1] (408) 263-0119

A&D INSTRUMENTS LIMITED

Unit 24/26 Blacklands Way, Abingdon Business Park, Abingdon, Oxfordshire OX14 1DY United Kingdom
Telephone: [44] (1235) 550420 Fax: [44] (1235) 550485

A&D AUSTRALASIA PTY LTD

32 Dew Street, Thebarton, South Australia 5031, AUSTRALIA
Telephone: [61] (8) 8301-8100 Fax: [61] (8) 8352-7409

A&D KOREA Limited

한국에이.엔.디(주)

서울특별시 영등포구 국제금융로6길33 (여의도동) 맨하탄빌딩 817 우편 번호 07331
(817, Manhattan Bldg., 33. Gukjegeumyung-ro 6-gil, Yeongdeungpo-gu, Seoul, 07331 Korea)
전화: [82] (2) 780-4101 팩스: [82] (2) 782-4264

OOO A&D RUS

ООО "ЭЙ энд ДИ РУС"

Почтовый адрес: 121357, Российская Федерация, г.Москва, ул. Верейская, дом 17
Юридический адрес: 117545, Российская Федерация, г. Москва, ул. Дорожная, д.3, корп.6, комн. 86
(121357, Russian Federation, Moscow, Vereyskaya Street 17)
тел.: [7] (495) 937-33-44 факс: [7] (495) 937-55-66

A&D Instruments India Private Limited

ऐ&डी इन्स्ट्रुमेंट्स इण्डिया प्रा० लिमिटेड

509, उद्योग विहार, फेस -5, गुडगांव - 122016, हरियाणा, भारत
(509, Udyog Vihar, Phase-V, Gurgaon - 122016, Haryana, India)
फोन : [91] (124) 4715555 फैक्स : [91] (124) 4715599

A&D SCIENTECH TAIWAN LIMITED. A&D台灣分公司 艾安得股份有限公司

台湾台北市中正區青島東路5號4樓
(4F No.5 Ching Tao East Road, Taipei Taiwan R.O.C.)
Tel : [886](02) 2322-4722 Fax : [886](02) 2392-1794

A&D INSTRUMENTS (THAILAND) LIMITED

บริษัท เอ แอนด์ ดี อินสตรูमेंท์ (ไทยแลนด์) จำกัด

168/16 หมู่ที่ 1 ตำบลรังสิต อำเภอธัญบุรี จังหวัดปทุมธานี 12110 ประเทศไทย
(168/16 Moo 1, Rangsit, Thanyaburi, Pathumthani 12110 Thailand)
Tel : [66] 20038911