

WinCT-ParamSet

Windows Balance Internal
Setting Tools

INSTRUCTION MANUAL



A&D Company, Ltd.

License Agreement

- Reproduction of "WinCT-ParamSet" without prior written consent from A&D is prohibited.
- "WinCT-ParamSet" specifications and this manual are subject to change without notice.
- Copyrights for "WinCT- ParamSet" are owned by A&D Company, Ltd.
- "WinCT-ParamSet" is intended for the transmission of data from an A&D weighing instrument to a PC.
- "WinCT-ParamSet " should only be installed on the hard disk or peripheral storage devices of a PC connected to an A&D weighing instrument.
- A&D Company, Ltd. bears no liability for direct, indirect, special, or consequential damages resulting from any defect in the "WinCT- ParamSet" program or this manual, even if advised of the possibility of such damage. Furthermore, A&D assumes no liability for claims of rights from third parties. Concurrently, A&D assumes no liability whatsoever for software or data losses.

Microsoft and Windows are trademarks or registered trademarks of Microsoft Corporation.

"WinCT-ParamSet" can be downloaded from the A&D website (<https://www.aandd.jp/>).

To setup "WinCT- ParamSet", please refer to the WinCT-ParamSet_SetUp_EN file in the downloaded A&D WinCT- ParamSet folder.

© 2020 A&D Company, Ltd. All rights reserved.

No part of this publication may be reproduced, transmitted, transcribed, or translated into any language in any form by any means without the written permission of A&D Company, Ltd.

Table of Contents

1. Software overview	2
2. Compatible models	3
2-1. Compatible weighing instruments.....	3
2-2. How to check the software version of the balance	3
3. How to connect	4
3-1. Connecting the weighing instrument to a PC with RS-232C.	4
3-2. Connecting the weighing instrument to a PC with USB.	5
4. Operation (common to both modes)	6
5. Description of each part	7
6. How to operate.....	9
6-1. Communication setting	9
6-2. Changing ID number.....	10
6-3. Changing internal settings	11
6-4. Initializing internal settings.....	13
6-5. Saving the contents of internal settings	14
6-6. Reading saved files.....	15
6-7. Directly changing the saved file	16
7. How to finish.....	17

1. Software overview

This software, “Windows Communication Tools for Parameter Setting” (“WinCT- ParamSet”), can change the internal settings of A&D electronic balances on a PC.

- The ID number and internal settings data can be read from the balance and changed all at once.
- The settings can be saved in CSV file format.
- The saved CSV file can be read and the settings written to the balance.

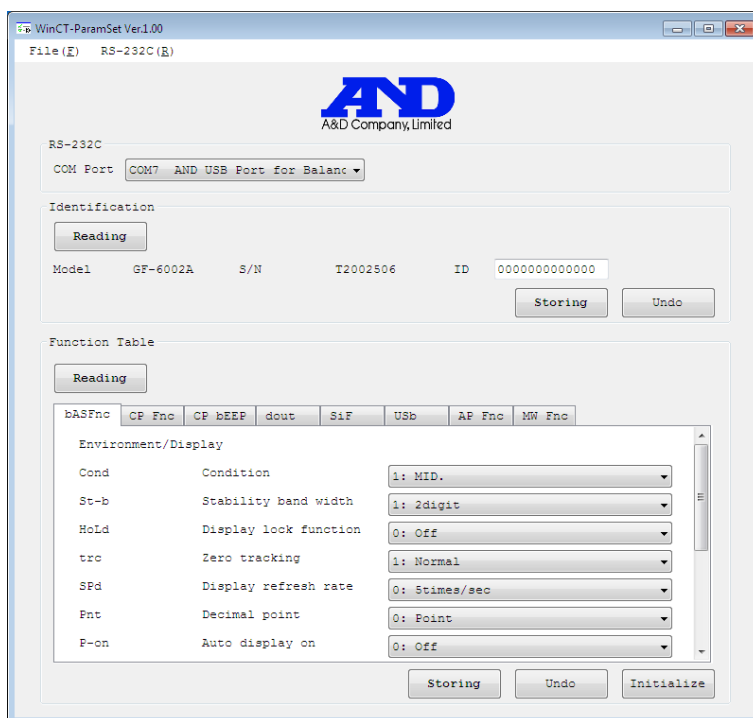

Caution

- Except for the ID settings, settings that require numerical input (eg: unit mass setting for piece counting, etc.) cannot be set with this software. Use the keys on the balance to set.
- This software cannot be used when the password lock function of the balance is enabled. Also, it cannot be used to change from disabled to enabled. Use the keys on the balance to set the password lock function.
- When writing the settings from a saved CSV file, the software version of the balance described in the CSV file must match the software version of the balance it will be written to.

2. Compatible models

2-1. Compatible weighing instruments

As of November 2020

Weighing instrument	Model	Software Version
Precision balances	BA series	Available in all versions
	GX-AE/GX-A/GF-A series	1.400 or later
	GX-M/GF-M series	Available in all versions
	FZ-i/FX-i series	4.310 or later

2-2. How to check the software version of the balance

Step1 Insert the AC adapter of the balance again.

Step2 For the GX-AE / GX-A / GF-A series, the LEVEL display flashes. (For the other models, proceed to Step3)

Step3 After that, the P- *.*.*.* is displayed.

The number in “*.*.*.*” is the software version.

3. How to connect

3-1. Connecting the weighing instrument to a PC with RS-232C.

D-Sub 9- pin arrangement

Pin No.	Signal name	Direction	Meaning, remarks
1	-	-	N.C. (same potential as SG)
2	TXD	Output	Transmitted data
3	RXD	Input	Received data
4	-	-	N.C.
5	SG	-	Signal ground
6	DSR	Output	Data set ready
7	RTS	Input	Request to send
8	CTS	Output	Clear to send
9	-	Output	N.C. (12V output)

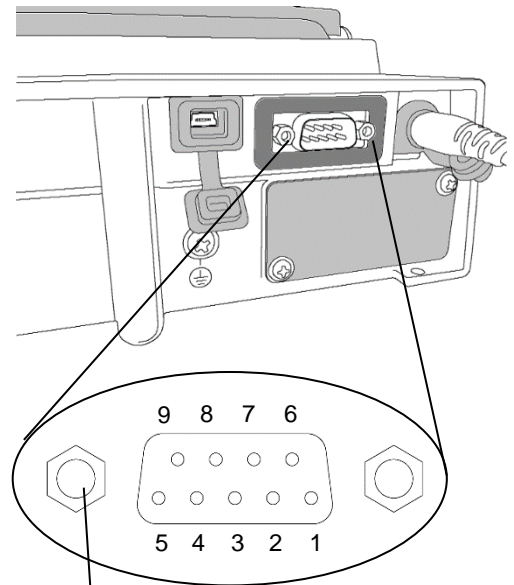

DTE signal names (except TXD and RXD).

Connection diagram (when connecting to a PC)

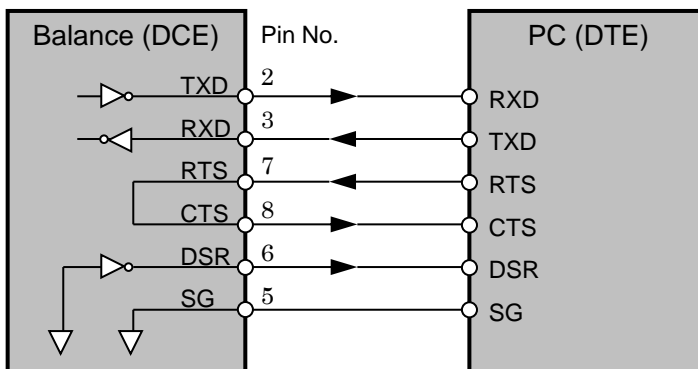

Inch screw #4-40 UNC

1) **If the PC is equipped with an RS-232C port:**

After checking the D-Sub 9-pin arrangement of the weighing instrument and the pin arrangement of the PC, connect with an appropriate RS-232C cable.

2) **If the PC is not equipped with an RS-232C port, or if you want to use the PC's USB port:**

- **Required cable** AX-USB-9P USB converter and cable set
(The USB driver must be installed.)

- **Installing the driver**

1. Connect the USB converter to the PC's USB port.
2. Install the driver on the PC.
For installation, please refer to the instruction manual of the USB converter.
3. Connect the USB converter to the measuring device with the included RS-232C cable.
The COM port name will be "USB Serial Port".

3-2. Connecting the weighing instrument to a PC with USB.

(FZ-i/FX-i series is not available)

- Required cable...USB cable supplied with the balance (The driver installation is required.)
- Preparation...Change the balance's internal settings to 'Virtual COM' mode.
 1. Set the balance to the weighing mode $^{\circ} 000 \text{ g}$.
 2. Press and hold the **SAMPLE** key (approx. 2sec.) to display the **bRSFnC** key.
 3. Press the **SAMPLE** key several times and press the **PRINT** key with the **USB** key.
 4. The **UFnC** is displayed. Press the **RE-ZERO** key several times to display **UFnC V_{COH}**.
 5. Press the **PRINT** key to return to the internal setting.
 6. Press the **CAL** key with the **RPFnC** to return to the weighing mode.

- Installing the driver

For Windows10

Connect the balance to the PC and the driver will be installed automatically.

The COM port name is "USB serial device".

For Windows8.1 or Windows7

- (1) Download the driver "Virtual COM mode" from the A&D website (<https://www.aandd.jp>) and decompress it.
- (2) Install the driver to connect the balance to the PC with the USB cable, referring to "Installation of driver for GX-A / GF-A series USB interface 'Virtual COM mode' in the folder.

The COM port name will be "AND USB Port for Balance".

Note

- For weighing instruments other than GX-AE / GX-A / GF-A series, please refer to the manual of the intended model.
- Operation with this software is not guaranteed when connected to a balance made by another company.
- For details on the PC, please contact each manufacturer.

4. Operation (common to both modes)

To begin, click the **Start** button on the PC.

Then, navigate to **All Programs > A&D WinCT-ParamSet > WinCT-ParamSet** to start WinCT-ParamSet. Also, you can start by double-clicking the WinCT-ParamSet icon on the desktop.

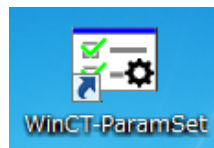
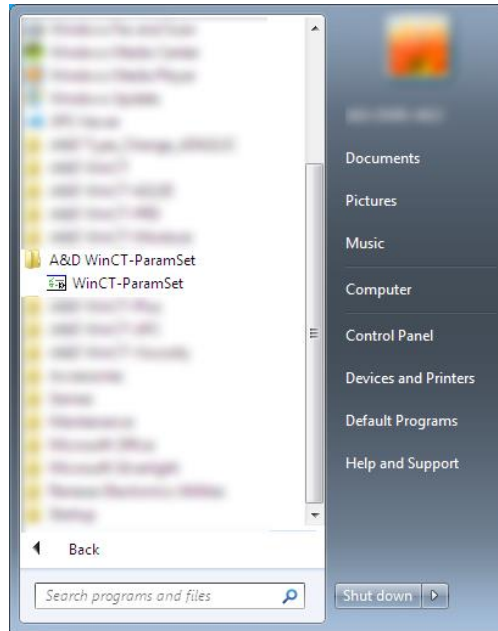

【RS-232C】

- ④ COM Port Sets COM port (Displays the list of available ports.)
- ⑤ Progress bar Displayed during communication with the balance and indicates the progress of processing.

【Identification】

- ⑥ “Reading” button Starts reading of the individual information of the balance.
- ⑦ Balance information display Displays information read from the balance.
 - [Model] Displays the model name of the balance.
 - [Serial number] Displays the serial number of the balance.
 - [ID] Displays the ID number of the balance.
To change the ID number, select it and enter it directly.

Note : The characters that can be entered are limited to single- byte alphanumeric characters.
- ⑧ “Storing” button Sends the changed ID number to the balance.
- ⑨ “Undo” button Returns the changed ID number to the value at the time of data acquisition.

【Function table】

- ⑩ “Reading” button Starts reading the balance’s internal settings.
- ⑪ Function table display Displays the internal settings read from the balance.
 - For details on the internal setting items, refer to the balance instruction manual.
 - Tab Displays the internal setting classification items.
 - In tab The first tab is the description tab of the category item. After that, the setting items, contents, and setting values are displayed from left to right.
To change the setting value, select from the list of setting values.

Note : Not all setting items are displayed on the tab. To change an item that is not displayed, use the keys on the balance.
- ⑫ “Writing” button Sends the changed setting to the balance.
- ⑬ “Undo” button Returns the changed setting value to the value at the time of data acquisition.
- ⑭ “Initialize” button Returns the balance settings to their initial values.

Note : Setting items that are not displayed on the tab are not initialized. To initialize the items that are not displayed, use the keys on the balance.

6. How to operate

6-1. Communication setting

Step1 Select [COM port] in [RS-232C] and then select the COM port to connect to the balance.

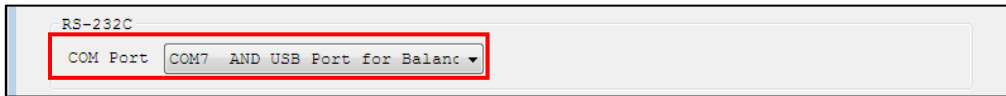

Step2 Click [RS-232C] menu.

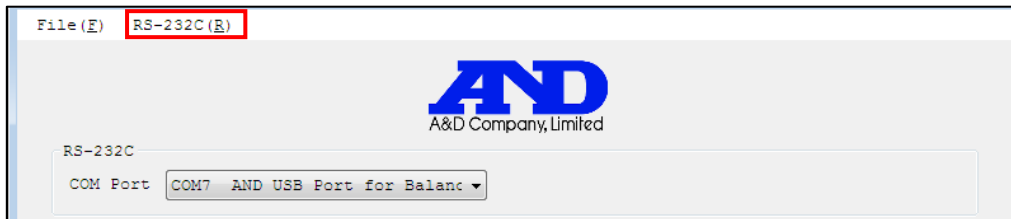

Step3 Match the [Baud rate], [Parity] and [Data length] settings with the settings of the balance.
(The default communication setting of WinCT-ParamSet is the same as the factory setting.)

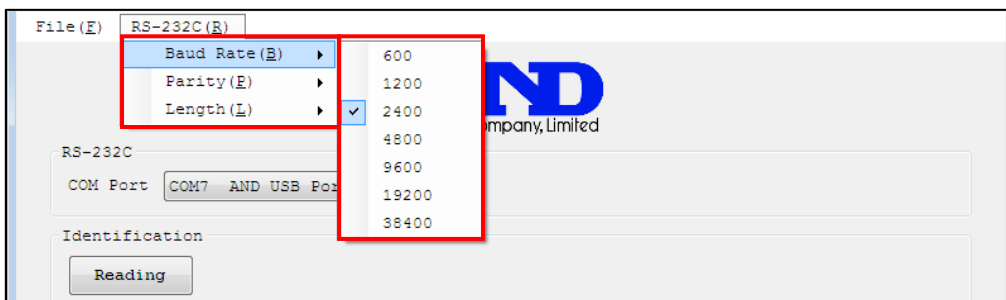

6-2. Changing ID number

Step1 Click the [Reading] button in [Identification].



Step2 Communication with the balance starts and the model name, serial number, and ID number are read.

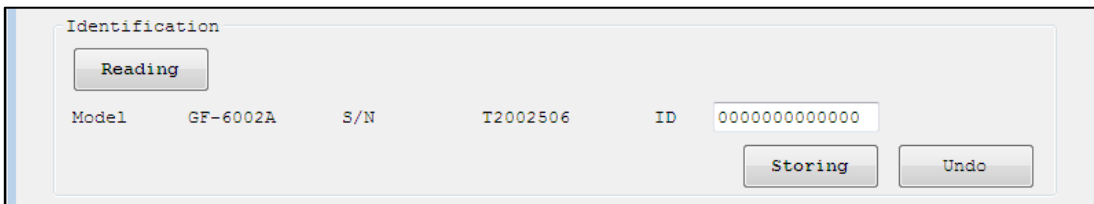

Step3 Enter the ID number in [ID] and click [Storing].

★Click [Undo] to return the ID number at the time of reception.

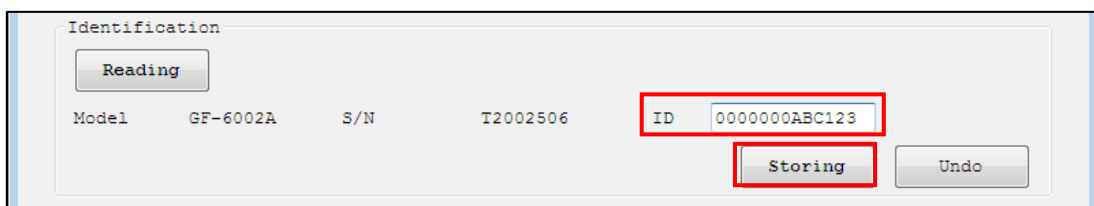

Step4 The confirmation dialog will appear. Click [OK].

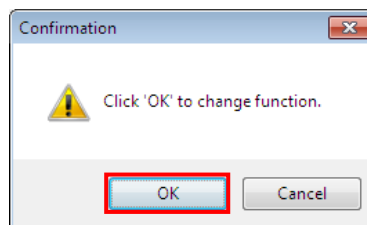

Step5 Communication with the balance starts and the setting data is sent.

When transmission is completed successfully, a dialog with [Successfully completed] is displayed. Click [OK].

★Even after clicking on the setting data, the ID number can be returned at the time of reception to click "Undo".

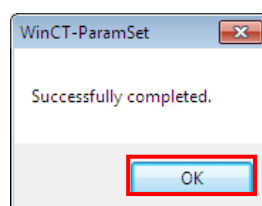

6-3. Changing internal settings

Step1 Click [Reading] button.

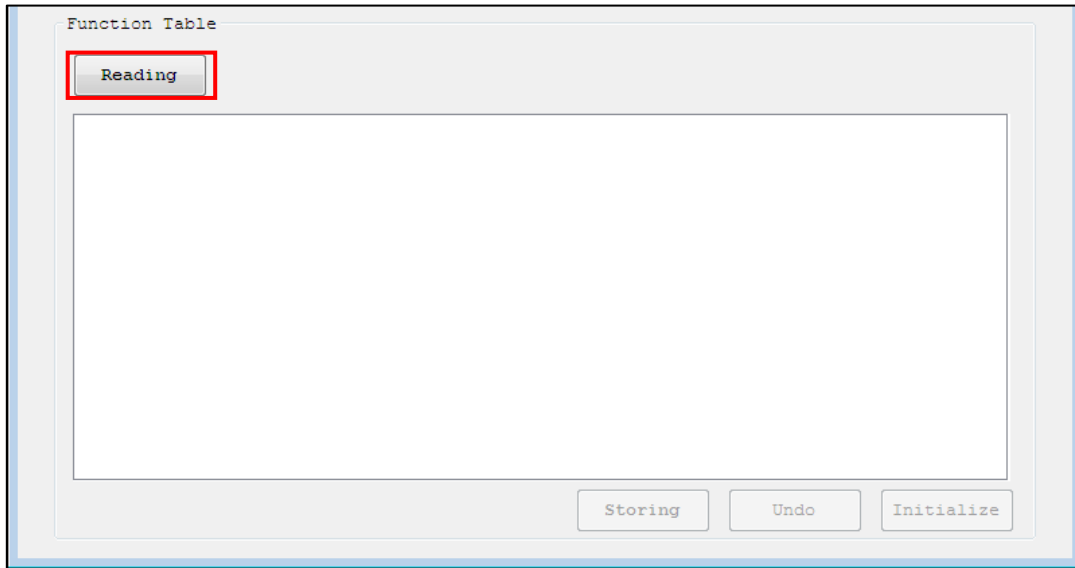

Step2 Communication with the balance starts and the information of the internal settings is read. This takes about 1 minute. (At baud rate 2400bps)

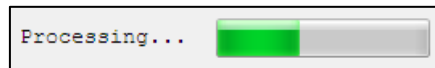

Step3 If received correctly, tabs will be assigned to each category item, and each setting item will be displayed.

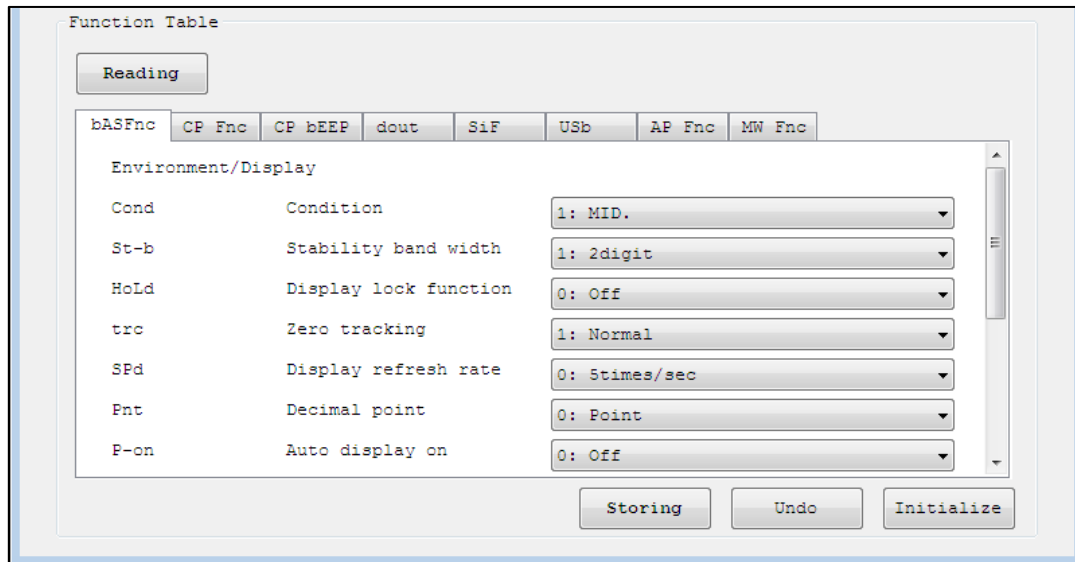

Step4 Select a setting item and change the setting value to the desired value.

★ Click [Undo] key to return to the state when the selected item was received.

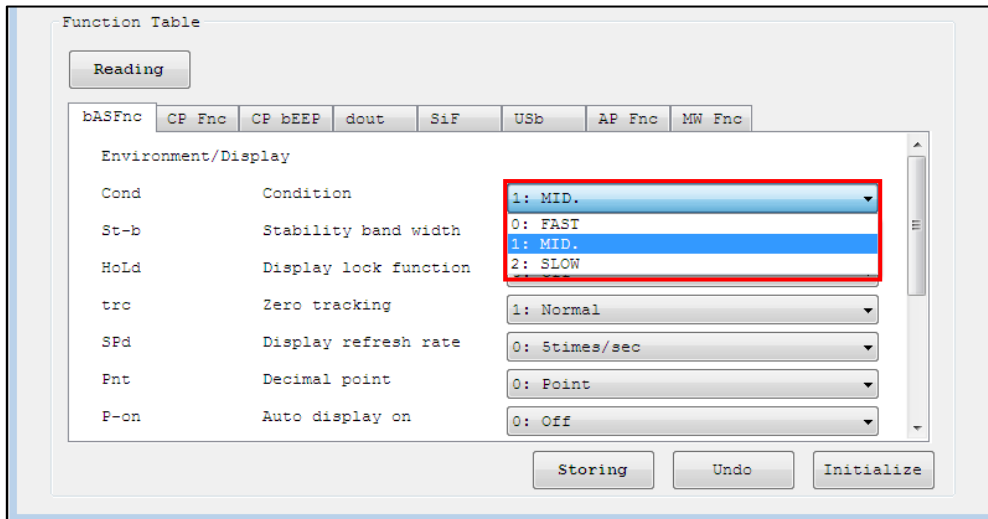

Step5 When all setting values have been selected, click [Storing] button.

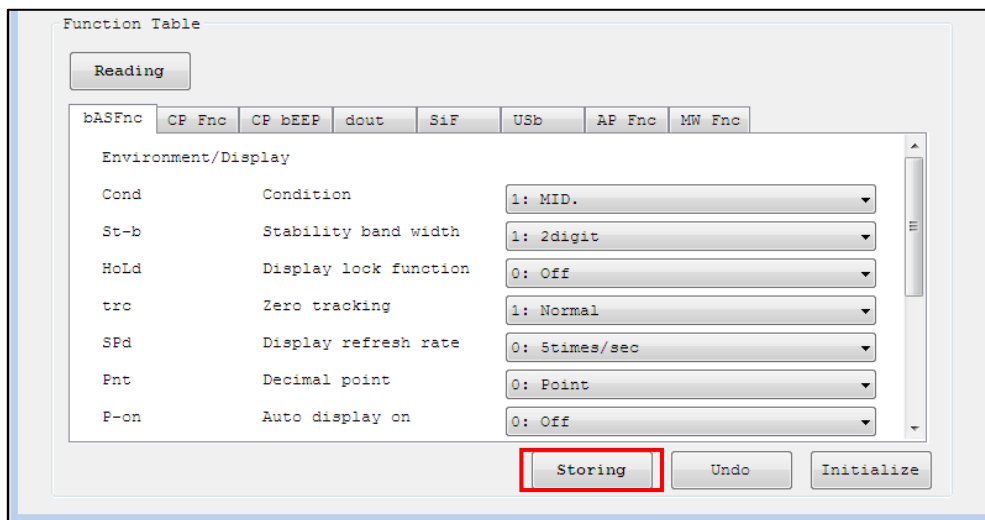

Step6 The confirmation dialog will appear. Click [OK].

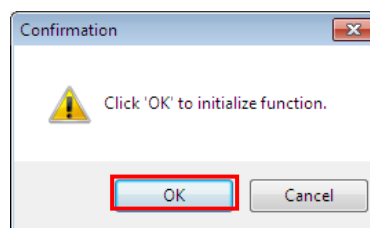

Step7 Communication with the balance starts and the setting data is sent.

When transmission is completed successfully, a dialog with [Successfully completed] is displayed. Click [OK].

★Even after clicking on the setting data, the ID number can be returned at the time of reception to click "Undo".

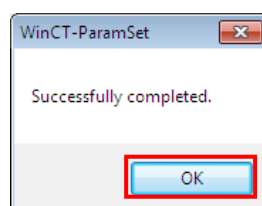

6-4. Initializing internal settings

Step1 [Initialize] with the internal setting information loaded in the [Function Table]

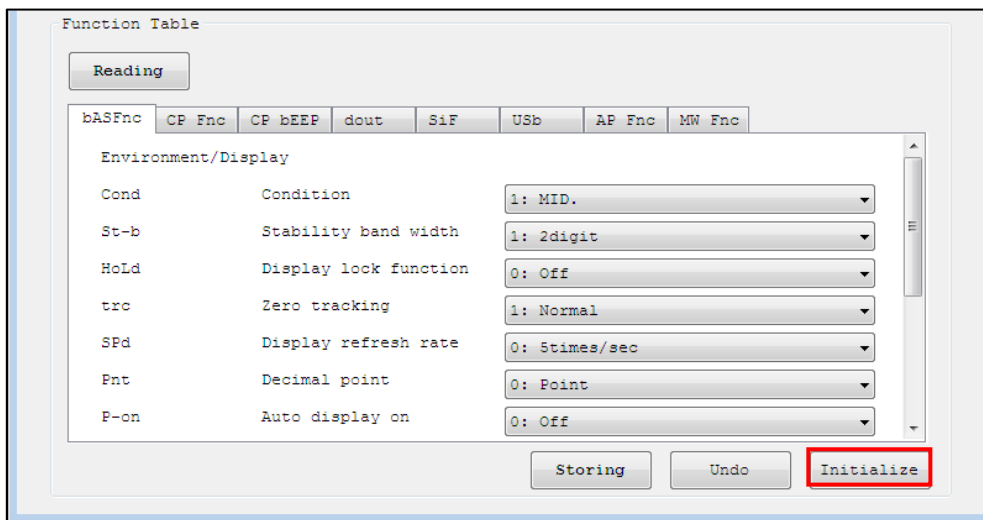

Step2 The confirmation dialog will appear. Click [OK].

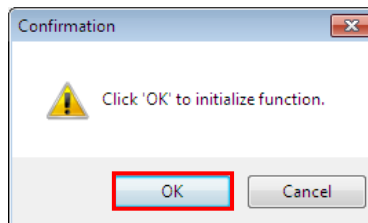

Step3 Communication with the balance starts and the initial setting data is sent. When transmission is completed successfully, a dialog with [successfully completed] is displayed. Click "OK".



Note

- Only the setting items displayed in [Function table] are initialized . (Excludes USB interface operation mode.)

6-5. Saving the contents of internal settings

Step1 Click [Save(S)] in the [File(F)] menu with the information of the internal settings loaded in the [Function table].

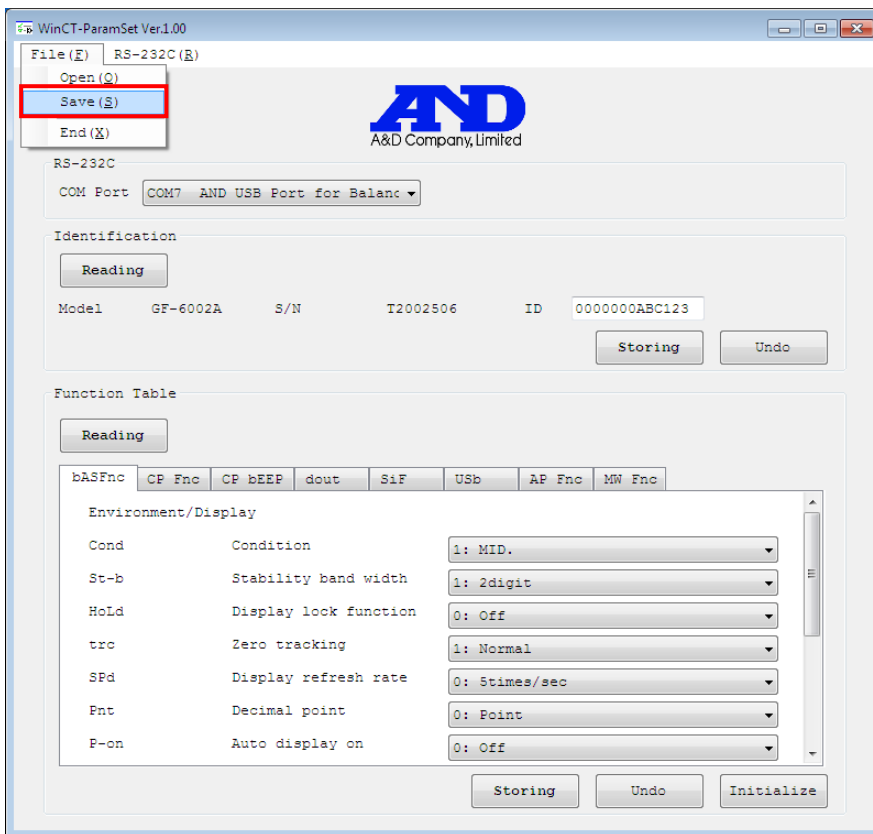

Step2 A dialog is displayed. Specify the folder to save to, enter a file name and click [Save(S)].

6-6. Reading saved files

Step1 Click [Open(O)] in the [File(F)] menu.

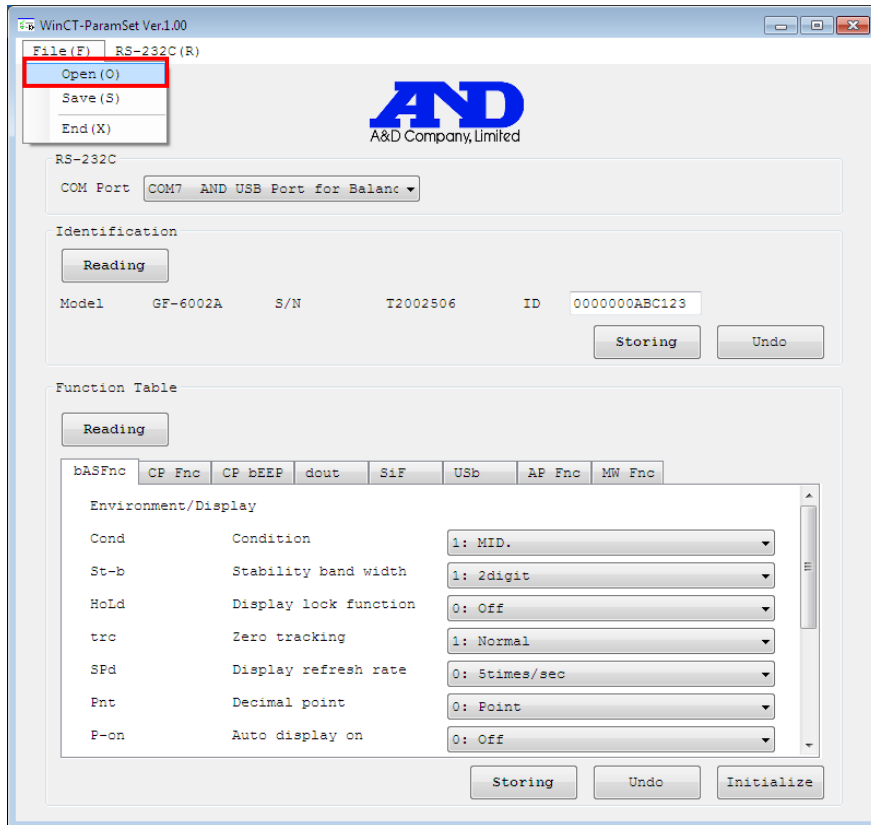

Step2 A dialog is displayed. Specify the CSV file to read and click [Open(O)].

Step3 When the reading of the file is completed, the contents of the internal settings saved in the [Function table] are displayed.

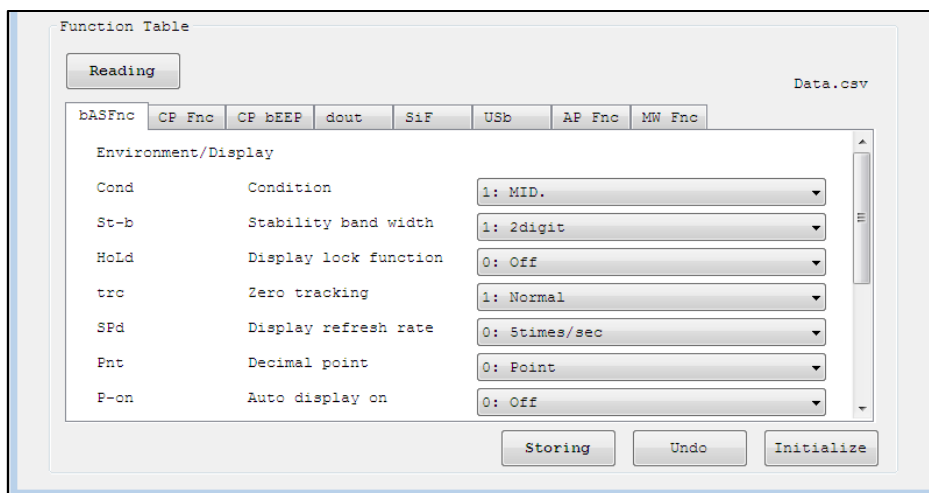

Note

- If the software version stored in the read CSV file and the software version of the balance do not match, the data cannot be stored.

6-7. Directly changing the saved file

Step1 Open in Excel the CSV file to be changed.

A	B	C	D	E	F	G	H	I	J		
1	WinCT-ParamSet										
2	GF-6002A	Ver 1.403				You can only change this column					
3	Class number	Display	Description	Class number	Item number	Upper limit	Setting value	Initial value	Command name	Display	Description
4	0	bAS Fnc	Environment/Display	0	0	2		1	#COND	Cond	Condition
5	1	CL Adj	Clock	0	1	2		1	#STB	St-b	Stability bank
6	2	CP Fnc	Comparator	0	2	1		0	#HOLD	HoLd	Display lock
7	3	CP VALUE	Comparator limit	0	3	3		1	#TRC	trc	Zero trackin
8	4	CP bEEP	Comparator beep	0	4	2		0	#SPD	SPd	Display refre
9	5	dout	Data output	0	5	1		0	#PNT	Pnt	Decimal poir
10	6	SIF	Serial interface	0	6	1		0	#PON	P-on	Auto display
11	7	USb	USB Interface	0	7	1		0	#POFF	P-off	Auto display
12	10	AP Fnc	Application	0	8	1		0	#RNG	rnG	Minimum dis
13	11	MW Fnc	Minimum weight alart	0	9	1		0	#BEEP	bEEP	Beep
14	12	Unit	Unit	0	13	1		0	#ZERO	P-Zero	Tare memor
15	15	Id	ID number setting	0	14	9		5	#DLED	dIS-P-LEd	Display light
16	16	PASSwd	Password	0	15	1		0	#LLED	LV-LEd	Level gauge
17				0	16	1		1	#ISD	isd	Impact Shoc
18				5	0	6		0	#PRT	Prt	Data output
19				5	1	2		0	#APP	AP-P	Auto print pt
20				5	2	2		0	#APB	AP-b	Auto print di
21				5	3	2		0	#DATA	dATA	Data memor
22				5	4	8		1	#INT	int	Interval time
23				5	5	1		0	#DNO	d-no	Data number
24				5	6	3		0	#STD	S-td	Time/Data c
25				5	7	1		0	#SID	S-id	ID number o
26				5	8	1		0	#PUSE	PUSE	Data output
27				5	9	1		0	#ATF	At-F	Auto feed
28				5	10	2		0	#INFO	inFo	GLP output
29				5	11	1		0	#ARD	Ar-d	Zero after o
30				5	14	1		0	#UFC	UFC	UFC
31				6	0	2		0	#MODE	ModE	Communicat
32				6	0	6		2	#BPS	bPS	Baud rate
33				6	1	2		0	#BTPr	btPr	Data bit/Par
34				6	2	1		0	#CRLF	CrLF	Terminator
35				6	3	5		0	#TYPE	tYPE	Data format
36				6	4	1		1	#TUP	t-UP	Timeout
37				6	5	1		0	#ERCD	ErCd	AK/Error co
38				10	0	4		0	#APP	APP	Application f
39				10	1	3		0	#STAF	StAF	Statistical di
40				10	2	5		0	#FLUN	Frd Unit	Flow rate ur

Step2 To change the setting value, replace the value in the column labeled "You can only change this column".

Note : Do not change any values or text other than those in this column, as this may cause the software to malfunction.

A	B	C	D	E	F	G	H	I	J		
1	WinCT-ParamSet										
2	GF-6002A	Ver 1.403				You can only change this column					
3	Class number	Display	Description	Class number	Item number	Upper limit	Setting value	Initial value	Command name	Display	Description
4	0	bAS Fnc	Environment/Display	0	0	2		1	#COND	Cond	Condition
5	1	CL Adj	Clock	0	1	2		1	#STB	St-b	Stability bank
6	2	CP Fnc	Comparator	0	2	1		0	#HOLD	HoLd	Display lock
7	3	CP VALUE	Comparator limit	0	3	3		1	#TRC	trc	Zero trackin
8	4	CP bEEP	Comparator beep	0	4	2		0	#SPD	SPd	Display refre
9	5	dout	Data output	0	5	1		0	#PNT	Pnt	Decimal poir
10	6	SIF	Serial interface	0	6	1		0	#PON	P-on	Auto display
11	7	USb	USB interface	0	7	1		0	#POFF	P-off	Auto display
12	10	AP Fnc	Application	0	8	1		0	#RNG	rnG	Minimum dis
13	11	MW Fnc	Minimum weight alart	0	9	1		0	#BEEP	bEEP	Beep
14	12	Unit	Unit	0	13	1		0	#ZERO	P-Zero	Tare memor
15	15	Id	ID number setting	0	14	9		5	#DLED	dIS-P-LEd	Display light
16	16	PASSwd	Password	0	15	1		0	#LLED	LV-LEd	Level gauge
17				0	16	1		1	#ISD	isd	Impact Shoc
18				5	0	6		0	#PRT	Prt	Data output
19				5	1	2		0	#APP	AP-P	Auto print pt
20				5	2	2		0	#APB	AP-b	Auto print di
21				5	3	2		0	#DATA	dATA	Data memor
22				5	4	8		1	#INT	int	Interval time
23				5	5	1		0	#DNO	d-no	Data number
24				5	6	3		0	#STD	S-td	Time/Data c
25				5	7	1		0	#SID	S-id	ID number o
26				5	8	1		0	#PUSE	PUSE	Data output
27				5	9	1		0	#ATF	At-F	Auto feed
28				5	10	2		0	#INFO	inFo	GLP output
29				5	11	1		0	#ARD	Ar-d	Zero after o
30				5	14	1		0	#UFC	UFC	UFC
31				6	0	2		0	#MODE	ModE	Communicat
32				6	0	6		2	#BPS	bPS	Baud rate
33				6	1	2		0	#BTPr	btPr	Data bit/Par
34				6	2	1		0	#CRLF	CrLF	Terminator
35				6	3	5		0	#TYPE	tYPE	Data format
36				6	4	1		1	#TUP	t-UP	Timeout
37				6	5	1		0	#ERCD	ErCd	AK/Error co
38				10	0	4		0	#APP	APP	Application f
39				10	1	3		0	#STAF	StAF	Statistical di
40				10	2	5		0	#FLUN	Frd Unit	Flow rate ur

Step3 After changing the settings, overwrite the file or save it in CSV format.

Note : Files saved in other than CSV format cannot be read by this software.

7. How to finish

To end WinCT-ParamSet , Click [End(X)] in the [File(F)] menu or click the “×” (Close) button in the upper right of the window.

