

AD-4715

INSTRUCTION MANUAL

Infrared Moisture Balance

AND

Infrared Moisture Balance Safety Precautions

Death, injury or damage to property may result if proper safety procedures are not followed when using the infrared moisture balance. Furthermore, some parts of the moisture balance become very hot and could cause burns if the device is handled incorrectly.

■ Be sure to carefully follow all safety precautions.



Carefully read all safety information in the safety precautions and user's manual.









■ Do not use the unit if it is not functioning properly.





Immediately contact our service representative if the unit malfunctions or does not operate properly.







■ Meaning of Warning Indications.

The symbols indicated below are used in the user's manual, these safety precautions and on the unit itself in order to prevent accidents due to misuse of the product. These symbols have the following meanings:



 Warning	This symbol indicates information which if ignored could result in death or serious injury to the user.
 Caution	This symbol indicates information which if ignored could result in injury to the user or material damage.
 Note	This symbol indicates information important for the understand in order to safely operate the product.

Warning Symbols			Symbols Indicating Prohibited Action			Instructional Symbols	
							
Fire	Burn	Electric Shock	Prohibited	Do Not Disassemble	Contact with Water Prohibited	Required	Disconnect Power Supply Cord from Outlet

 Warning			
	Fire	Burn	Electric Shock

-  ● Do not attempt to perform measurements on samples which may undergo dangerous chemical reactions if heated. Doing so may result in explosion or release of poisonous gas, etc.
-  ● Do not place flammable material near the infrared moisture tester. Doing so may result in fire as some parts of the moisture tester become very hot.
-  ● Do not use the infrared moisture balance with any power supply voltage other than specified voltage. Connecting the unit to a power supply of excessive voltage will result in overheating and may cause a fire.
-  ● Do not touch the lamp cover or sample directly with your hands. Doing so may result in burns. The infrared moisture balance become very hot during measurement and remains hot for some time after measurements are made. Use the proper operating knobs and supplied tools when touching the unit.
-  ● Disconnect the unit's power supply cord from the outlet when replacing the infrared lamp. Electric shock may result if fingers or metal objects are accidentally inserted into the lamp socket.
-  ● Disconnect the power supply cord from the electrical outlet before attempting to replace the lamp.

 Caution
--

-  ● Do not attempt to disassemble or modify the infrared moisture tester. Doing so may result in damage to the unit, electric shock or fire. If you suspect the product is not functioning properly, please contact an authorized service representative.
-  ● Do not allow the unit to become wet. This product is not designed to be water resistant. Electric shock or damage to the unit may occur if water gets inside. Electric shock may also result if the unit is placed on a wet surface.

Contents

1. Notes and Cautions	7
2. Functions and Special Features of the Model AD-4715 Infrared Moisture Balance ..	8
2.1 Principle of Measurement	8
2.2 Special Features	8
2.3 Applications (substances suitable for measurement)	8
2.4 Specifications	9
3. Before Getting Started	10
3.1 Part Names and Functions	10
3.2 Parts and Accessories	11
4. Getting Started (Unit assembly and installation)	12
5. The Display and Controls	16
5.1 The Display	16
5.2 Control Functions	17
6. The Measurement Conditions Area	18
7. Settings	20
7.1 Type of Settings	20
7.2 Initial Settings and Saving Settings	21
7.3 Description of Settings	22
7.3.1 UNIT (Measurement standard and minimum number of digits)	22
7.3.2 TEMP (Drying temperature)	24
7.3.3 MODE (Measurement mode)	25
7.3.4 OUTPUT (Data output format)	30
7.3.5 CODE (Sample codes)	31
7.3.6 DATE (Measurement start date)	32
7.3.7 Setting the Measurement Complete Buzzer	33
8. Measurement Procedures	34
9. Notes Regarding Measurement.....	37

10. About the Predicted Measurement Mode	39
11. Data Output Settings	42
11.1 Output Format Selection (OUTPUT)	42
11.2 Output Interval Setting (Interval)	42
11.3 Graph Range Setting (Graph)	43
11.4 Output Format Setting Example (OUTPUT).....	44
11.5 Printer Output Example	46
11.6 Computer Output Format	50
11.6.1 Title	50
11.6.2 Measurement Process	51
11.6.3 Measurement Results	51
12. Communications with Computers	52
12.1 RS-232C Interface Specifications	52
12.2 Communications Standards and Format.....	53
12.3 Command Control	54
12.3.1 Types of Commands	54
12.3.2 List of Settings Commands.....	55
12.3.3 Executable Commands	56
13. Using the Printer (Optional).....	58
13.1 Setting DIP Switches.....	58
13.2 Connection to the Main Unit and Print Out.....	59
14 Maintenance	60
14.1 Performing User Maintenance	60
14.2 Replacing the Infrared Lamp	61
14.3 Replacing the Fuse	61

1. Notes and Cautions

- When making measurements of samples which may pose a danger above a certain heating temperature, set the heating temperature within a safe range.
- Do not use or store this unit in any location subject to high or low temperatures, high humidity, direct sunlight, electromagnetic noise, corrosive gas or excessive dust.
- Operate the unit on a flat, stable surface.
- Do not tip the unit more than necessary when moving it.
- Do not drop or strike the unit or subject it to strong vibration or excessive force.
- When disconnecting the power supply cord or RS-232C cable, do not pull on the cord. Hold the plug when disconnecting these cables.
- When not using the unit for an extended period of time, turn the power switch off and disconnect the unit from the electrical outlet.
- When there is danger of lightning, turn the power switch off and disconnect the unit from the electrical outlet.
- If there is any strange smell, smoke or other possibly dangerous situation, turn the power switch off, disconnect the unit from the electrical outlet and take appropriate action.
- Do not turn on the power while pressing on operating keys.
- Except as otherwise specified, do not press multiple keys simultaneously.
- Wait for the unit to cool down completely before covering it with the dust cover.

2. Functions and Special Features of the Model AD-4715 Infrared Moisture Balance

2.1 Principle of Measurement

This unit determines the moisture and solid components of samples by heating them using infrared illumination and measuring changes in mass due to evaporation. This is referred to as the dehydration mass loss method and is the simplest method for determining moisture content and thus mandated by many public regulations related to measurement standards.

2.2 Special Features

- ① The AD-4715 provides wet base (%), dry base (%) and solid component measurements.
- ② The AD-4715 features a variable mass sampling format that makes measurement easier.
- ③ The AD-4715 features 10 measurement condition areas so that area measurement conditions can be set for a variety of samples so as to expedite the measurement process.
- ④ The AD-4715 features a new predicted measurement mode that allows highly precise predicted measurements to be made quickly.
- ⑤ By connecting a printer, it is possible to print out information regarding the drying state during measurement and final measurement values as either text data or graphics.
(Graphic print out must be used AD-8120 Printer)

2.3 Applications (substances suitable for measurement)

- ① This model is useful for samples from which water is the major component vaporized by heating.
- ② This AD-4715 is not applicable to samples which may undergo dangerous chemical reactions when heated.

Almost any type of sample meeting these two conditions may be measured using the AD-4715.

2.4 Specifications

Measurement format	: Evaporation mass loss method (Infrared heating and drying mass loss method)
Sample masses	: Any mass between 1 ~ 300g
Minimum measurable sample mass	: 1mg
Minimum displayable moisture content (solid component)	: 0.01% (switchable)
Measurement range	: Wet base standard moisture content and solid component 0~100% Dry base standard moisture content 0~500%
Measurement precision	: Sample 3g or greater : ±0.1% Sample 1g or greater, less than 3g : ±0.2%
Display format	: Digital LCD display
Display content	: <When setting measurement conditions> • Setting item (7 types) • Setting content < During measurement > • Measurement time • Drying temperature • Sample mass • Measured value (moisture or solid component)
Drying complete format (Measurement mode)	: ① Drying time setting (Timed measurement mode) ② Moisture content fluctuation monitoring (automatic measurement mode) ③ Predicted final measurement value (Predicted measurement mode)
Measurement conditions area	: Optional area (0) 1 Registration area (1 ~ 9) 9
Temperature measurement method	: By thermistor
Temperature control format	: PID control
Temperature setting range	: 40 ~ 200°C (1° increments)
Heat source	: 400W infrared lamp (130mm diameter)
Sample pan	: 130mm diameter x 15mm deep (stainless steel)
I/O Interfaces	: Standard RS-232C Serial interface For connection to optional printer or computer.
Output data	: Initial data, final data and measurement process data (time, temperature, moisture or solid component)
Output format	: Text or graphical format (graphical format for AD-8120 only)
Environmental conditions	: Temperature 5~40°C, humidity 30~80%, no condensation
Power supply	: 100V AC (50/60Hz)
Power consumption	: 410W
External dimensions and weight	: (W) 194mm x (D) 319mm x (H) 331mm, approx. 5.4kg.

3. Before Getting Started

3.1 Part Names and Functions

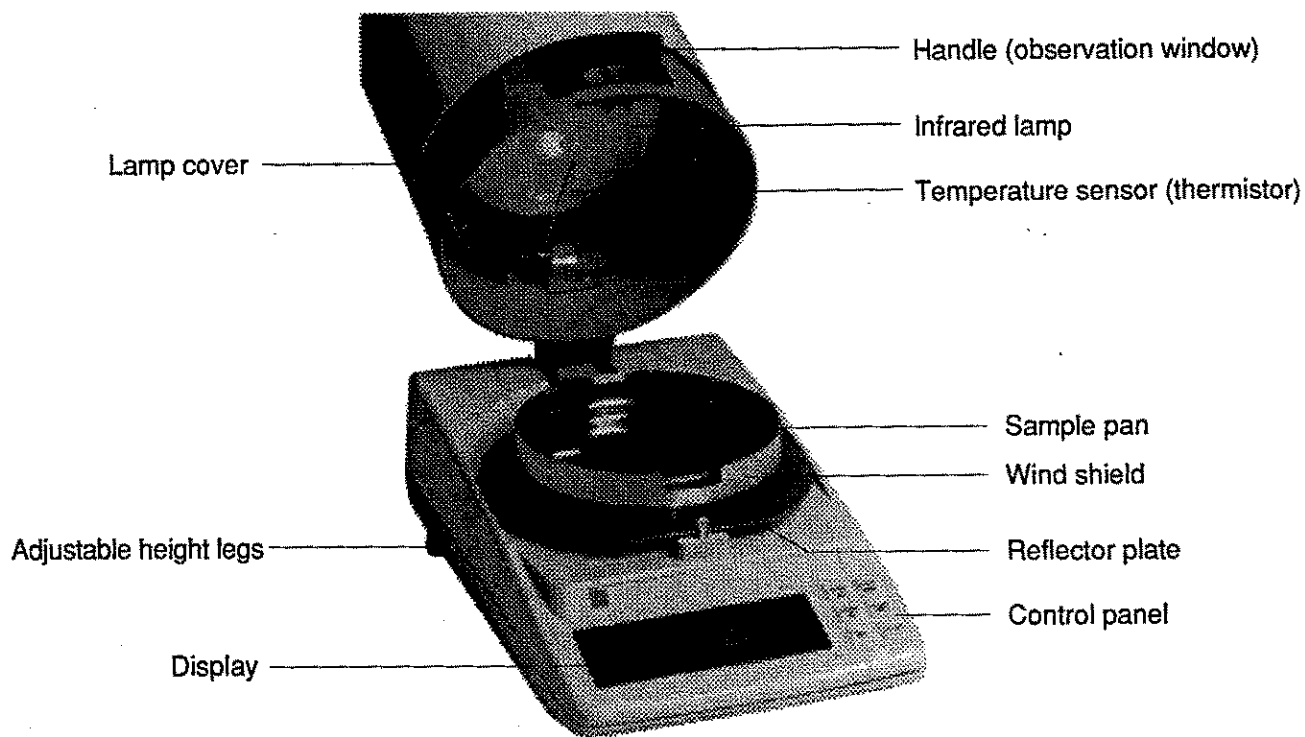

- * To open the lamp cover, press the handle down to release the lock.
To close, grasp the handle and push until the lamp cover locks completely.

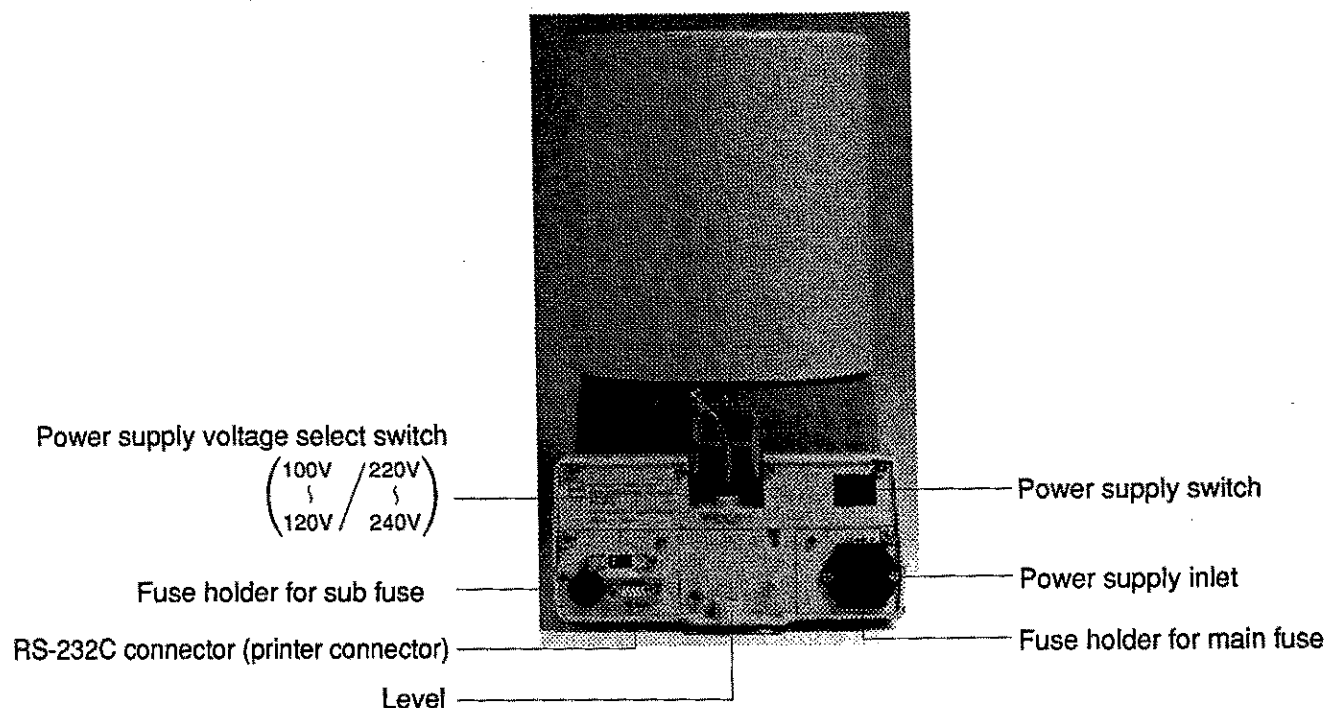

3.2 Parts and Accessories

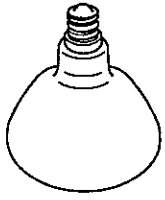

① Infrared lamp (2)

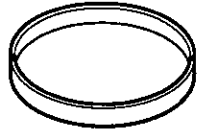

② Sample pan (2)

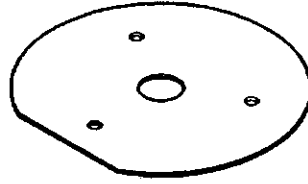

③ Reflector plate (1)

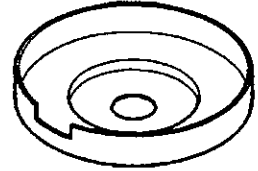

④ Wind shield (1)



⑤ Sample pan support (1)

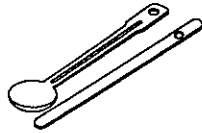

⑥ Spoon and spatula (1 each)

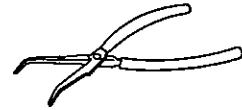

⑦ Sample pan gripper (1)



⑧ Extra fuses

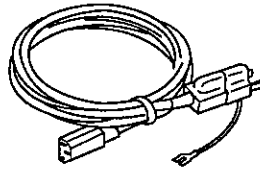

⑨ Power supply cord (1)

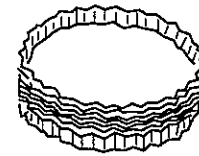

⑩ 10 aluminum sheets (2 sets)

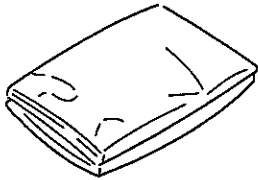

⑪ Dust cover

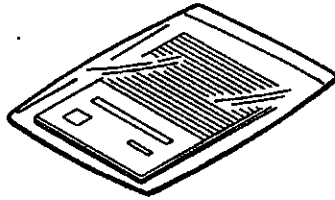

⑫ User's Manual

Power Supply Voltage	Main Fuse	Sub Fuse
AC 100V ~ 120V	10 A	0.5 A
AC 220V ~ 240V	3 A	0.3 A

4. Getting Started (Unit assembly and installation)

① Place on a flat surface.

Set the unit on a flat stable surface that is resistant to the effects of vibration and wind.

* Leave a little space behind the unit so that it is not struck when the dust cover is put on.

② Check the power supply voltage

Check to make sure that the power supply voltage select switch on the rear of the unit is set to the actual voltage to be used.

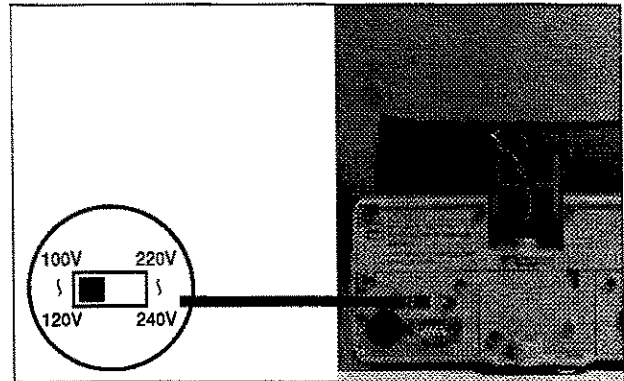

③ Check to make sure that the unit is level.

Check the level on the rear of the unit to ensure that the unit is level.

(The unit is level if the bubble is within the red circle in the center of the level.)

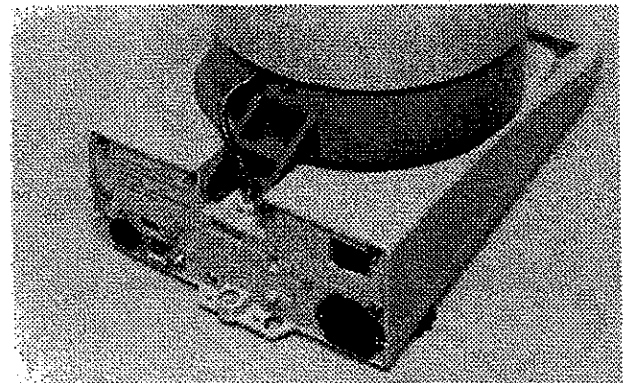

▲ The level is located on the rear of the unit

④ Level the unit if it is leaning

If the unit is not level, turn the adjustable legs so that the bubble in the level is within the red circle.

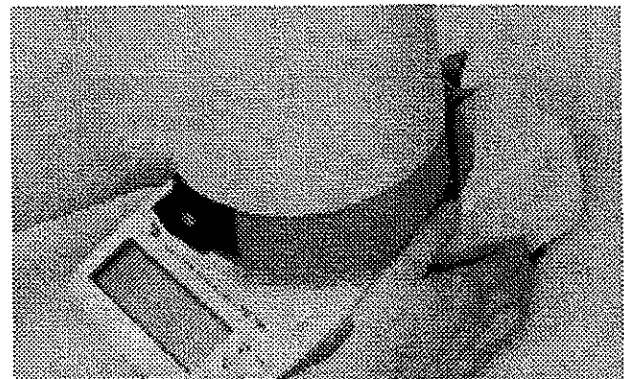
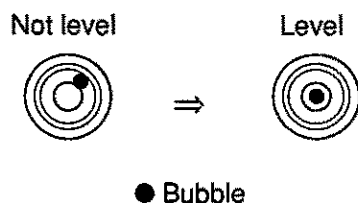

▲ The adjustable legs are located on the both of the rear sides of the unit.

⑤ Open the lamp cover

Press the handle down to disengage the lock and then open the cover.

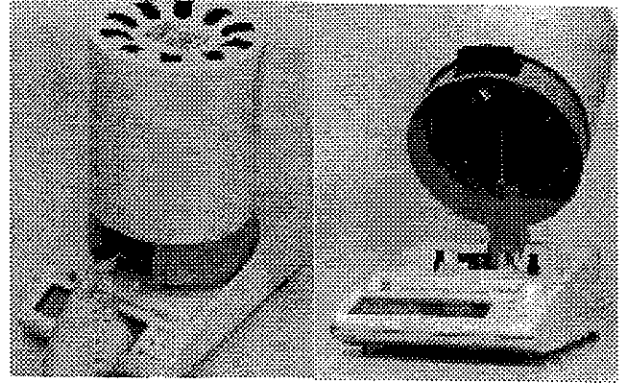

⑥ Move the temperature sensor

Press in the protruding part on the left side of the temperature sensor fitting and rotate the temperature sensor down.

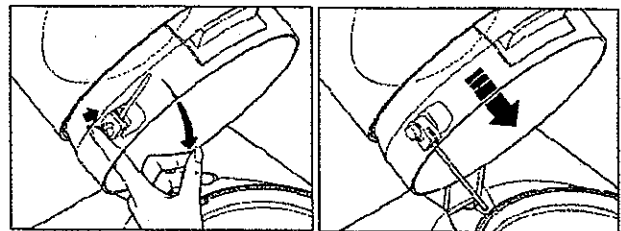

⑦ Install the infrared lamp.

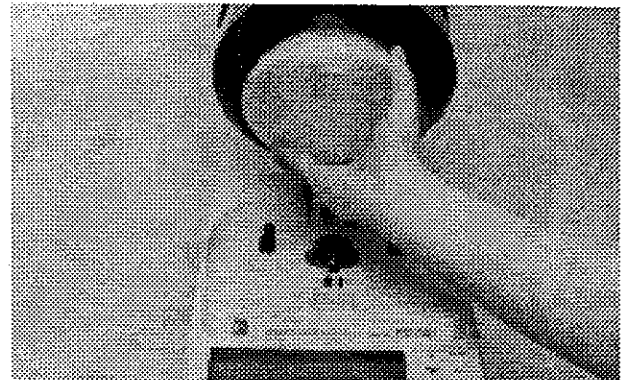

▲ Screw the infrared lamp hard

⑧ Return the temperature sensor to its original position.

Position the temperature sensor in the prescribed position at the front center of the lamp. Check that a click sound is heard and the sensor is fixed in position.

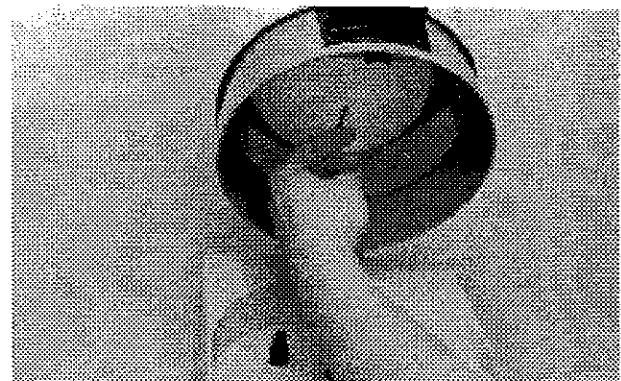

⑨ **Install the reflecting plate**

Position the reflecting plate so that the cut is located in the front as shown in the photo and then match the hole in the plate with the tab.

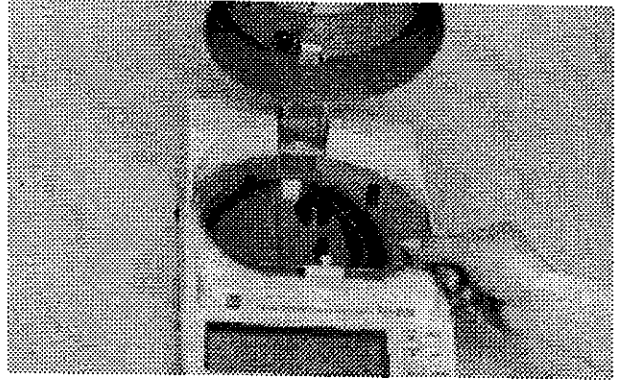

⑩ **Install the wind shield**

Set the wind shield so that the cut out part is facing forward.

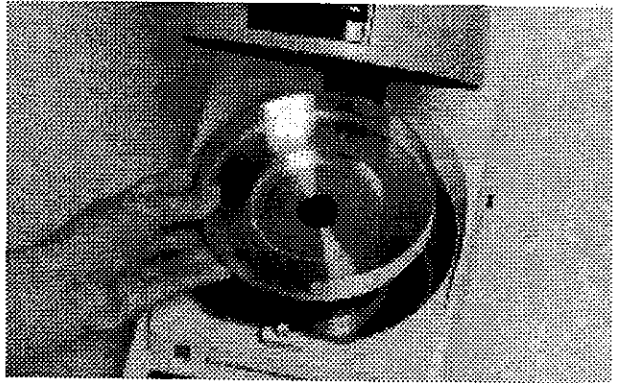

⑪ **Set the sample support in place.**

Gently insert the center pillar of the sample support into the hole in the center of the wind shield.

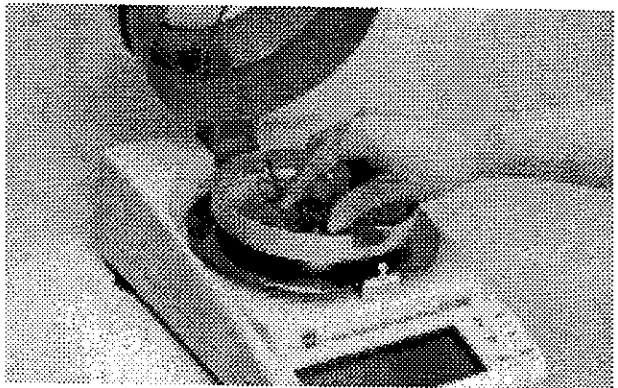

Insert gently without tilting

⑫ **Place the sample pan.**

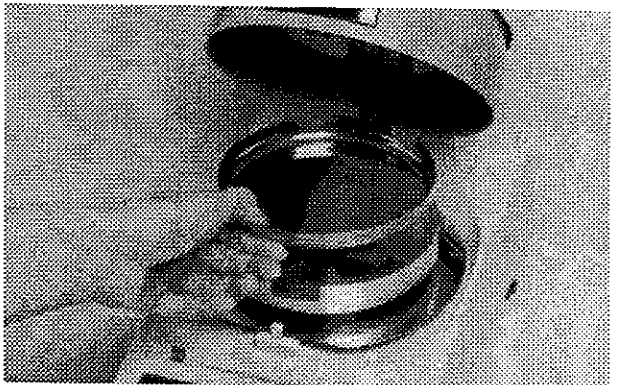

Gently place the sample pan on the sample support.

⑬ Open the lamp cover

Press the lamp cover down until it locks in place.

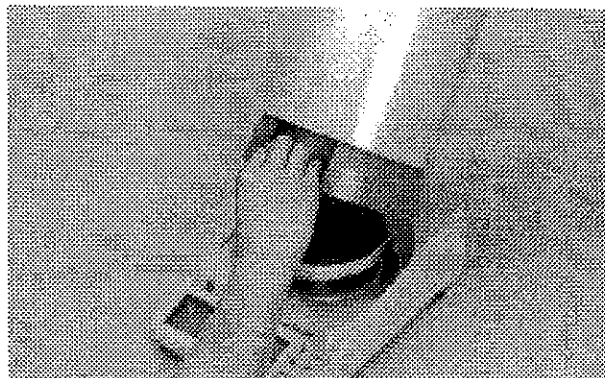

⑭ Connect the power supply cord.

Insert the power supply cord into the inlet on the back of the unit.

Next connect the power cord to a main outlet.

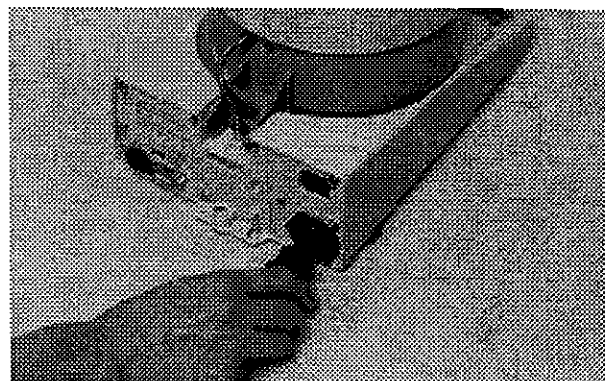

⑮ Connect to the printer

If using a printer, use the special connection cable.

This completes assembly.

5. The Display and Controls

5.1 The Display

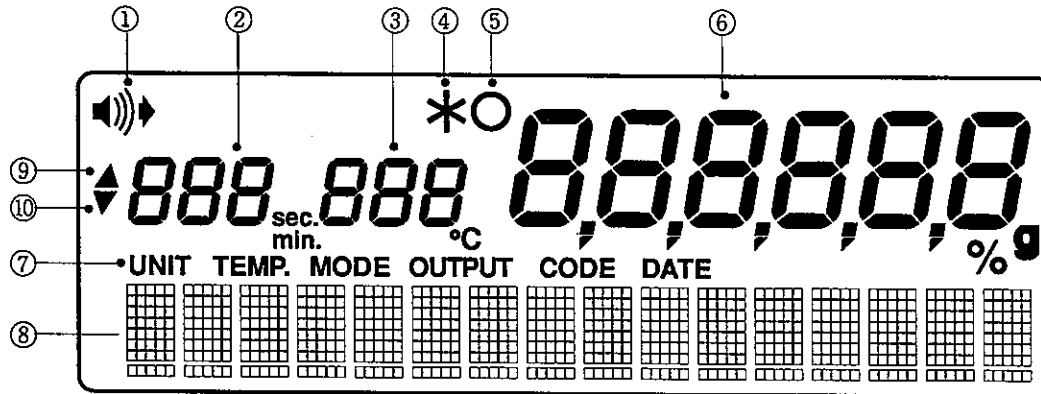

All indicators displayed when power turned on.

① Buzzer mark

This indicator is displayed when the buzzer volume (high or low) and time (continuous, 15 second intervals) is set.

② Time (^{min.}/_{sec})

Displays the set drying time and monitoring time. Min. stands for minutes, Sec. stands for seconds.

③ Temperature (°C)

Displays the set drying temperature and temperature during drying.

④ Hold Mark

Lights when the mass or measured value is being held (fixed display).

⑤ Stable mark

Lights when the weigh unit stabilizes.

⑥ Moisture content (%) / Solid component (%) / Mass (g)

Displays the moisture content, solid component or mass.

"H" is displayed if the mass exceeds the scale range or "L" if it the mass is too low to measure.

⑦ Setting Items

The 7 types blink in order. The item currently blinking can be set.

The buzzer mark blinks during buzzer setting.

⑧ Setting Content Display

Displays the set content.

⑨ Up Mark

Lights when the elapsed measurement time is displayed.

(During auto measurement mode or predicted measurement mode.)

⑩ Down Mark





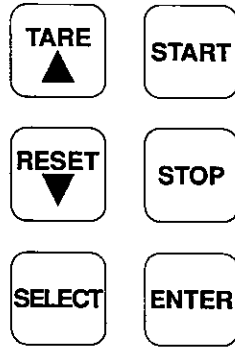

Lights when the measured time remaining is displayed. (During timed measurement mode.)

5.2 Control Functions



The various keys perform the functions described below.

Please refer to the page indicated after each item for details.

 TARE Key (Up Key)	<ul style="list-style-type: none"> ● Used for zero adjustment or tare weight removal (⇒P34) ● Used to change settings or to increase set values. (⇒P20)
 RESET Key (Down Key)	<ul style="list-style-type: none"> ● Used to return the unit to its initial state after making a measurement. (⇒P36) ● Used to release mass hold. (⇒P35) ● Used to change settings or to decrease set values. (⇒P20)
 SELECT Key	<ul style="list-style-type: none"> ● Used to select a setting item. (⇒P20)
 START Key	<ul style="list-style-type: none"> ● Used to begin settings. (⇒P35)
 STOP Key	<ul style="list-style-type: none"> ● Used to abort measurement or to turn off the buzzer after measurement is complete. (⇒P35). ● Used to engage the mass hold mode. (⇒P35)
 ENTER Key	<ul style="list-style-type: none"> ● Used to confirm the various settings. (⇒P20) (After confirming, moves to the next item if there are more or otherwise completes the setting procedure.)
 ENTER + SELECT	<ul style="list-style-type: none"> ● Used to set the measurement conditions area and to confirm content. (⇒P19) The SELECT key is pressed while holding down the ENTER key.

6. The Measurement Conditions Area

● The Measurement Condition Areas

- When using this unit to measure moisture content (solid component), the measurement conditions must be set beforehand. The following settings exist:

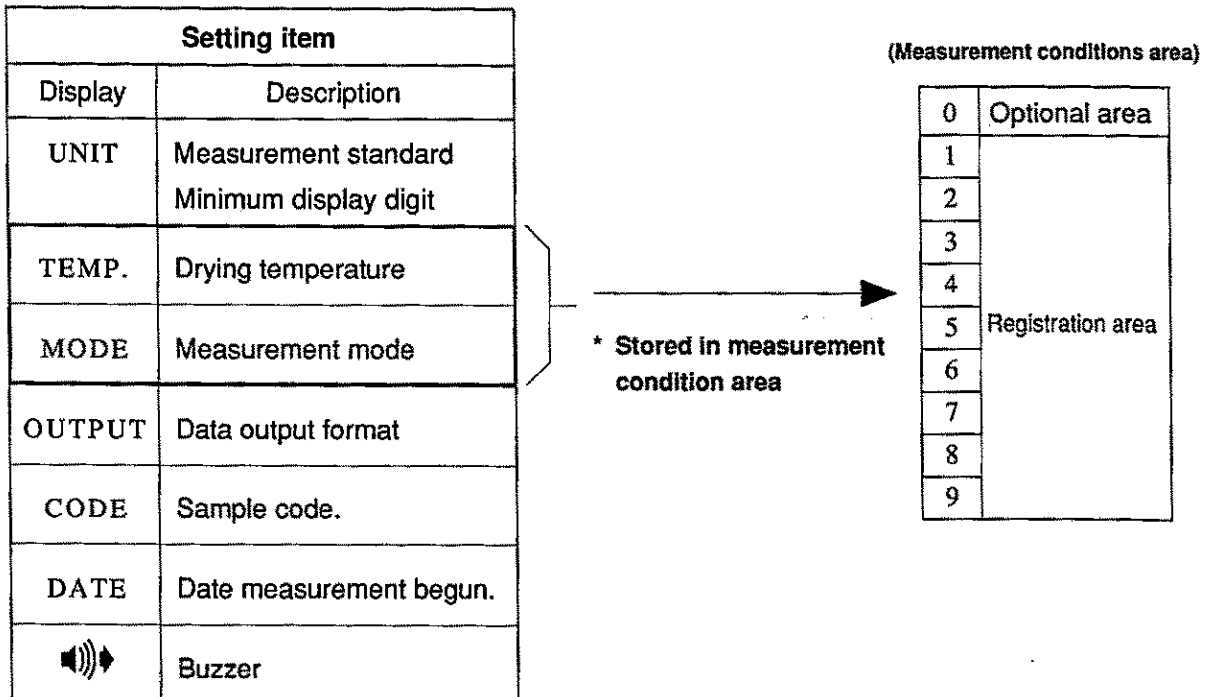

With this unit, of the setting items indicated above, **10 measurement conditions areas** are provided for storage of the ***measurement conditions (drying temperature and measurement mode)**.

Before making the settings, first select the measurement conditions area in which they will be stored.

The measurement conditions area contain **one area for optional settings** and **9 registration areas** for registering measurement conditions obtained in the optional area.

● Optional Area (Condition Number 0)

The optional area is used for measurement conditions that need not be registered or to obtain measurement conditions suited to a particular sample.

- * **The unit is set to this conditional area when shipped from the factory. If complex measurement conditions are not necessary this area does not need to be changed.** When making measurements in the optional area, nothing is displayed on the main unit but "0" is printed from the printer or displayed on a connected computer.

● **Registration areas (Condition Numbers 1 ~ 9)**

The registration areas are used to store measurement conditions obtained in **the optional area**. When measuring a variety of sample types, registering the measurement conditions in these areas makes it possible to eliminate the bother of making measurement condition settings (drying temperature, measurement mode) each time the sample type is changed. Up to 9 sets of measurement conditions can be stored in these areas.









The area currently in use is displayed on the LCD, printer or computer title as a number ranging from **1 to 9**.

Once a registered area is set, it is maintained in memory even if the units power is turned off.

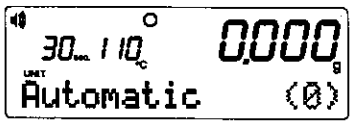
- * The measurement conditions stored in a registered area can be overwritten as necessary.
- * Measurement conditions set in the optional area cannot automatically be registered in a registration area. To register such conditions, first call up the registration area number and then input the necessary measurement conditions.

Measurement Area Selection Procedure

Example: Selecting registered area 3.

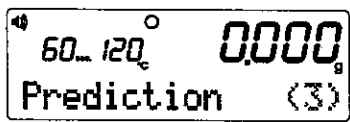
Operating procedure	Display	Explanation
 + 		Hold down the  key and then press the  key. The number displayed is incremented in sequence each time the  key is pressed.
 + 		Release the keys when the number of the desired registration area is displayed. This complete the registration area selection procedure.

7. Settings

The AD-4715 is a multi-functional moisture tester providing the capability to select and set measurement standards, display units, measurement conditions (drying temperature and measurement mode) and data output formats.

Make the necessary settings before beginning measurements.

Also, the same procedure is used to change settings as to set them originally.

Settings are maintained in the unit's internal memory until set again and therefore do not need to be made each time measurements are made.

7.1 Type of Settings

Setting Item	Display	Content	
UNIT (Measurement standard)	Wet-Base Moist.	Wet-base moisture	Select one of the three standards:
	Dry-Base Moist.	Dry-base moisture	
Solid Content.	Solid content		
Least Digit	0.1%	Select one:	Display to 0.1%
	0.01%		Display to 0.01%
TEMP.		Drying temperature	Set between 40° and 200°C
MODE (Measurement mode)	Drying Time	Time measurement mode	Measurement time is set from 1 to 990 minutes.
	Automatic	Auto measurement mode	Monitoring interval is set between 10 to 300 seconds.
	Pred	Predicted measurement mode	Monitoring interval is set between 10 to 300 seconds. Predicted value convergence range is set from 0.1 ~ 9.9% Compensation value is set between -9.99% and +9.99%.
	Comp	Comparison measurement mode	
OUTPUT (Output format)	Form : Computer	Output to computer	Set either measurement process or measurement result only. Set the graph span.
	Form : Print-Table	Chart on printer	
	Form : Print-Graph	Graph on printer	
	Form : OFF	No output	Results are not output
CODE		Used to classify data with combinations of 0 ~9 and A ~ Z.	
DATE		Set the measurement start date.	
	Sound Volume	Select either volume high or volume low	
	Buzzer mark Time	15sec. continue	Select either quit buzzing after 15 seconds or continue buzzing.

* Measurement conditions

* Stored in the currently selected measurement condition area. (P.18)

7.2 Initial Settings and Saving Settings

When first purchased and turned on, the various settings are initially set as indicated below.

Measurement conditions area	: Optional area (0)
Measurement standard	: Wet-base moist
Minimum displayed digit	: 0.1%
Drying temperature	: 110°C
Settings mode	: Auto measurement mode
Monitoring time	: 30 seconds
Predicted value convergence range	: 0.5%
Compensation value	: 0%
Data output format	: Off
Buzzer volume, time	: High, 5 seconds

All settings are maintained even when the unit's power is off.

The unit is automatically restored to the previous settings when the power is turned on again.

7.3 Description of Settings

The following seven setting items are available: UNIT, TEMP, MODE, OUTPUT, CODE, DATE and  Buzzer.

Each press of the  key moves the blinking indicator to the next of the above setting items so that each item can be set.

7.3.1 UNIT (Measurement standard and minimum number of digits)



The UNIT setting determines the measurement standard and the minimum digit.

● Setting the measurement standard

First, determine which measurement standard is to be used for measurement.

The three types of measurement standards indicated in the chart below are available.

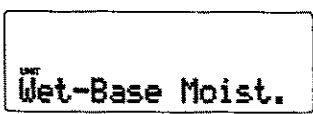
Select a measurement standard that is appropriate for the type of sample being measured.

Type	Display during setting	Formula	Description
Wet-Base Moisture		$(W-S)/W \times 100(\%)$	Ratio of evaporated moisture to the mass before drying.
Dry-Base Moisture		$(W-S)/S \times 100(\%)$	Ratio of evaporated moisture to the mass after drying
Solid Content		$S/W \times 100(\%)$	Ratio of solid component remaining after moisture has evaporated to mass before drying

Formula symbols:

W : Undried mass when measurement begun.

S : Dried mass when measurement completed.









(During measurement, the mass at that point is considered the dried mass for calculation of the measurement value.)

● Setting the minimum measurement digit

Select whether the minimum measurement digit is to be set to 0.1% or 0.01%.

UNIT (measurement standard and minimum digit) setting procedure

Example: Setting the measurement standard to dry-base moisture and the minimum display digit to 0.01%.

Operating procedure	Display	Explanation
<p>SELECT</p> <p>ENTER</p>	<p>UNIT TEMP. MODE OUTPUT CODE DATE Wet-Base Moist.</p> <p>UNIT Wet-Base Moist.</p>	<p>Press the  key until "UNIT" is blinking. The current measurement standard is displayed. Press the  key to make UNIT settings.</p>
<p>TARE ▲</p> <p>RESET ▼</p> <p>ENTER</p>	<p>UNIT Dry-Base Moist.</p>	<p>Press the  or  key until the desired measurement standard is displayed. Press the  key to measurement standard.</p>
<p>TARE ▲</p> <p>RESET ▼</p> <p>ENTER</p>	<p>UNIT Least Digit:0.1%</p> <p>UNIT Least Digit:0.01%</p>	<p>The setting moves to the minimum digit and the current setting blinks. Pressing the  or  key switches between 0.1% and 0.01%. Press the  key to set the minimum digit.</p>
	<p>30... 110 °C 0.000g</p> <p>Automatic</p>	<p>The setting procedure is completed and the unit returns to the normal display.</p>

* The time displayed during the Timed Drying mode is the time remaining for the measurement.

7.3.2 TEMP (Drying temperature)













The TEMP setting determines the temperature to which the sample is heated for drying. The temperature can be set between 40 and 200°C in 1°C increments.

With the AD-4715, the drying temperature is the sensor temperature. This is not necessarily the actual temperature of the sample. The temperature of the sample depends upon its color, moisture content, type and shape. Therefore an appropriate drying temperature must be determined for each type of sample.

In general, the higher the drying temperature the quicker the sample is dried. However, if the sample is burned the results obtained may not be correct. Therefore please set a temperature at which the sample will not be burned.

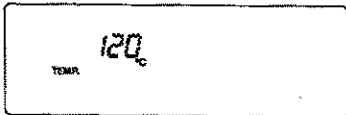
TEMP (temperature) setting procedure

Example: Setting the drying temperature to 120°C

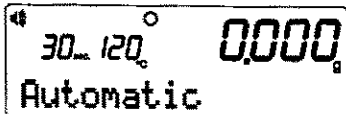
Key operations	Display	Description
 		Press the  key until "TEMP" is blinking. The current setting is displayed. Press the  key to make the TEMP setting.
  		Use the  and  keys to increase or decrease the displayed value. Press the  key to set the drying temperature.
		The setting procedure is completed and the unit returns to the normal display.

* The time displayed during the Timed Drying mode is the time remaining for the measurement.

7.3.3 MODE (Measurement mode)

The MODE setting determines the conditions under which measurement is completed. Three types of measurement modes are available. These are the **Timed Measurement Mode, Automatic Measurement Mode and Predicted Measurement Mode.**

First select the desired measurement mode and then proceed to make the necessary settings for the selected mode.

- **Timed Measurement Mode (Drying Time)**

In this mode, moisture and solid components are measured with the drying time is set beforehand. The measurement operation is completed and the measured value is displayed after the specified period of time elapses.

The measurement time can be set from 1 to 990 minutes.

The increments are 1 minute between 1 and 90 minutes and 30 minutes between 90 minutes and 990 minutes.

- **Automatic Measurement Mode (Automatic)**

In the Automatic Measurement Mode, measurement is completed automatically when the fluctuation in the measured value drops below 0.05% during the monitoring period specified beforehand.

The monitoring period is set in 10 second increments between 10 and 300 seconds. Although the measurement time is shorter if a shorter monitoring period is selected, measurement may stop while large fluctuations are still occurring.

Furthermore, if a longer monitoring period is selected a more accurate value is obtained but the time required to complete the measurement increases. Carefully select an appropriate monitoring period based upon the type of sample and the purpose for which the measurement is being made.

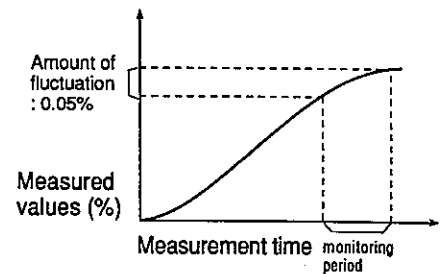

- **Predicted (Pred. Comp)**

This mode is used to shorten measurement times by calculating the predicted moisture content based on an extrapolation of the measured value fluctuations.

In this mode, the measured value is a composite of the comparison measurement performed in the first stage and the actual predicted measurement value. Please see "About the Predicted Measurement Mode" on page 39 for details.

- **Comparison measurement (Comp)**

The comparison measurement is performed to determine the compensation value used in the predicted measurement mode. This value is the difference between the value obtained in the Automatic Measurement Mode and the predicted value.

Set the monitoring period and prediction value convergence range.

- **Predicted Measurement (Pred)**

This is the mode used to actually perform predicted value measurements.

Set the same **monitoring period** used in the automatic measurement mode, **predicted value convergence range and compensation value** determined by the comparison measurement.

MODE (Measurement Mode) Setting Procedure



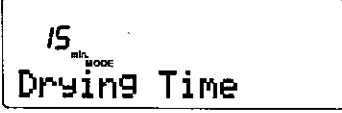
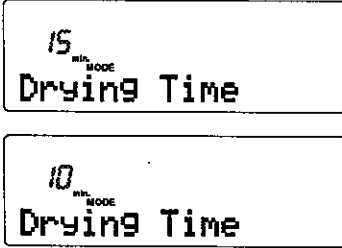
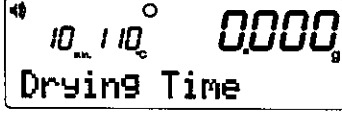









Example 1: Set the drying time to 10 minutes in the Timed Measurement mode.

Operating procedure	Display	Explanation
<p>SELECT</p> <p>ENTER</p>		<p>Press the SELECT key until the "MODE" indicator is blinking.</p> <p>The current measurement mode settings are displayed.</p> <p>Press the ENTER key to make MODE settings.</p>
<p>TARE ▲</p> <p>RESET ▼</p> <p>ENTER</p>		<p>Press the TARE ▲ or RESET ▼ key until "Drying Time" is displayed.</p> <p>Press the ENTER key to proceed to set the drying time.</p>
<p>TARE ▲</p> <p>RESET ▼</p> <p>ENTER</p>		<p>The drying time blinks.</p> <p>Use the TARE ▲ and RESET ▼ keys to increase and decrease the value.</p> <p>Press the ENTER key to set the drying time.</p>
		<p>The setting procedure is complete and the unit returns to the normal display.</p>

* The time displayed during the Timed Drying mode is the time remaining for the measurement.

MODE (measurement mode) Setting Procedure



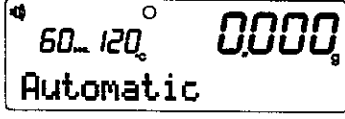

Example 2: Setting the monitoring period to 60 seconds in the Automatic Measurement Mode

Operating procedure	Display	Explanation
<p>SELECT</p> <p>ENTER</p>		<p>Press the  key until the "MODE" indicator is blinking. The current measurement mode settings are displayed. Press the  key to make MODE settings.</p>
<p>TARE ▲</p> <p>RESET ▼</p> <p>ENTER</p>		<p>Press the  or  key until "Automatic" indicator is displayed. Press the  key to proceed to set the monitoring period.</p>
<p>TARE ▲</p> <p>RESET ▼</p> <p>ENTER</p>	 	<p>The monitoring period blinks.</p> <p>Use the  and  keys to increase or decrease the value.</p> <p>Press the  key to set the period.</p>
		<p>The setting procedure is complete and the unit returns to the normal display.</p>

* The time displayed during the Timed Drying mode is the time elapsed for the measurement.

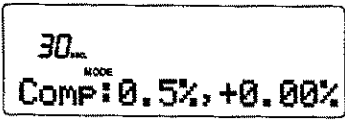
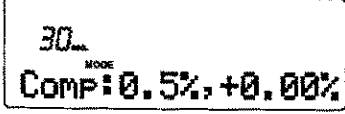
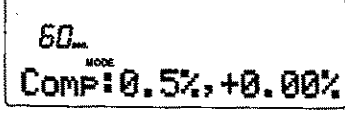
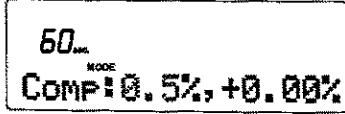

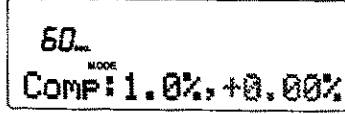
MODE (Measurement Mode) Setting Procedure

Example 3: Setting the monitoring period to 60 seconds for the Comparison Measurement Mode (Comp) and setting the predicted value convergence range to 1.0%.

Operating procedure	Display	Explanation
<p>SELECT</p> <p>ENTER</p>		<p>Press the SELECT key until the "MODE" indicator is blinking. The current measurement mode settings are displayed.</p> <p>Press the ENTER key to make MODE settings.</p>
<p>TARE ▲</p> <p>RESET ▼</p> <p>ENTER</p>		<p>Press the TARE or RESET key until "Comp" is displayed.</p> <p>Press the ENTER key to proceed to comparison measurement settings.</p>
<p>TARE ▲</p> <p>RESET ▼</p> <p>ENTER</p>	 	<p>The monitoring period blinks.</p> <p>Use the TARE and RESET keys to increase or decrease the value.</p> <p>Set to the same period used in the Automatic Measurement mode.</p> <p>Press the ENTER key to set the monitoring period.</p>
<p>TARE ▲</p> <p>RESET ▼</p> <p>ENTER</p>	 	<p>Proceed to the predicted value convergence range setting. The predicted value convergence range values blink.</p> <p>Use the TARE and RESET keys to increase or decrease the value.</p> <p>Press the ENTER key to set the predicted value convergence range.</p>
<p>TARE ▲</p> <p>RESET ▼</p> <p>ENTER</p>		<p>Proceed to the compensation value setting. The comparison measurement is used to obtain the compensation value, so set to 0 here.</p> <p>Press the ENTER key to validate the setting.</p>
		<p>The setting procedure is complete and the unit returns to the normal display.</p>

MODE (Measurement Mode) Setting Procedure

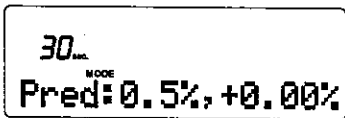
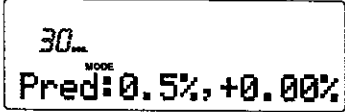
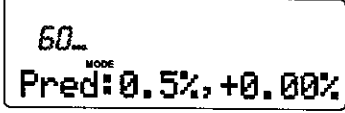
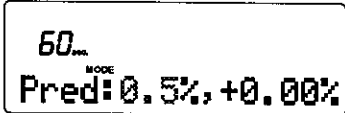
Example 4: Setting the Predicted Measurement Mode settings for a monitoring period of 60 seconds, predicted value convergence range to 1.0% and compensation value to +0.03%.

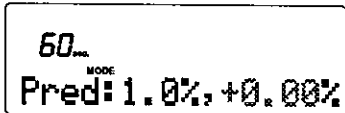
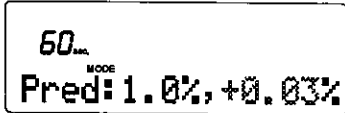
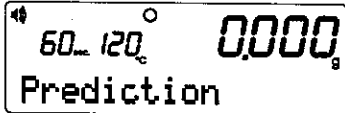
Operating procedure	Display	Explanation
<p>SELECT</p> <p>ENTER</p>		<p>Press the SELECT key until the "MODE" indicator is blinking. The current measurement mode settings are displayed.</p> <p>Press the ENTER key to make MODE settings.</p>
<p>TARE ▲</p> <p>RESET ▼</p> <p>ENTER</p>		<p>Press the TARE or RESET key until "Pred" is displayed.</p> <p>Press the ENTER key to proceed to predicted value measurement settings.</p>
<p>TARE ▲</p> <p>RESET ▼</p> <p>ENTER</p>	 	<p>The monitoring period blinks.</p> <p>Use the TARE and RESET keys to increase or decrease the value.</p> <p>Set to the same period used in the Automatic Measurement mode.</p> <p>Press the ENTER key to set the monitoring period.</p>
<p>TARE ▲</p> <p>RESET ▼</p> <p>ENTER</p>	 	<p>Proceed to the predicted value convergence range setting. The predicted value convergence range values blink.</p> <p>Use the TARE and RESET keys to increase or decrease the value.</p> <p>Press the ENTER key to set the predicted value convergence range.</p>
<p>TARE ▲</p> <p>RESET ▼</p> <p>ENTER</p>	 	<p>Proceed to the compensation value setting.</p> <p>Enter the value obtained in the comparison measurement. The compensation value blinks.</p> <p>Use the TARE and RESET keys to increase or decrease the value.</p> <p>Press the ENTER key to validate the setting.</p>
		<p>The setting procedure is complete and the unit returns to the normal display.</p>

7.3.4 OUTPUT (Data output format)

The **OUTPUT** setting determines the format and content of measurement data output to a printer or computer.

There are 4 possible **OUTPUT** settings. These are **Computer, Print-Table, Print-Graph and Off.**

Please refer to "Data Output Settings" on page 42 for details.

- **Computer**

Outputs measurement process and measurement results to a computer.

The output interval for measurement process data can be set.

Interval is used to set the measurement process output interval.

- **Print-Table**

Outputs measurement process and measurement results to a printer in text format.

The output interval for measurement process data can be set.

Interval is used to set the measurement process output interval.

- **Print-Graph**

Outputs measurement process and measurement results to a printer in graph format.

The output interval for measurement process data can be set.

Interval is used to set the measurement process output interval.

The graph output interval can be set.

Graph is used to set the desired graph span.

* "Print-Graph" setting is effective for AD-8120 only.

- **Off (no output)**

This setting is used when it is not necessary to output data to a computer or printer.

7.3.5 CODE (Sample codes)

The **CODE** setting determines the sample code transmitted to the printer or computer when measurement data is output.



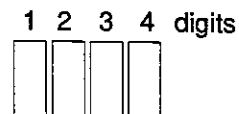









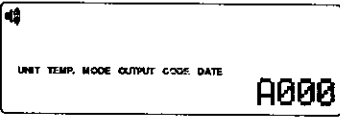























- Digits 1 and 2 are set using numbers 0 ~ 9, letters A ~ Z and SPACE.
- Digits 3 and 4 are only set using numbers 0 ~ 9.



The last two digits are automatically incremented each time a measurement is made.

CODE (Sample code) Setting procedure

Example: Setting the sample code to NO01.

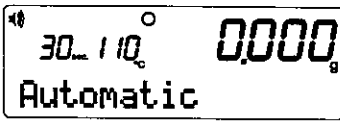











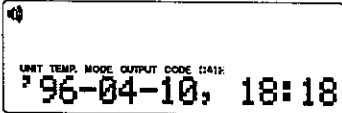





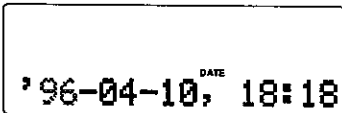





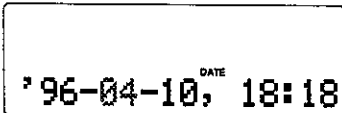
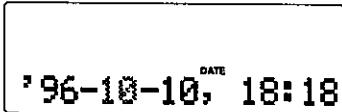





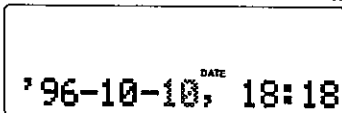
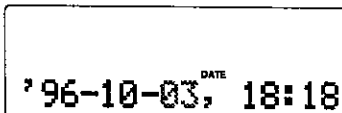



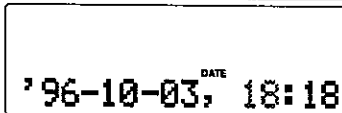
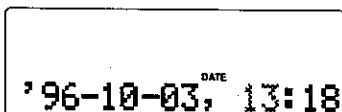

Operating procedure	Display	Explanation
 		Press the  key until the "CODE" indicator is blinking. The current sample code is displayed. Press the  key to proceed with the CODE setting.
  	 	The first digit blinks. Use the  and  keys to select the desired value. Press the  key to set the first digit.
  	 	The second digit blinks. Use the  and  keys to select the desired value. Press the  key to set the second digit.
  		The third digit blinks. Use the  and  keys to select the desired value. Press the  key to set the third digit.
  	 	The fourth digit blinks. Use the  and  keys to select the desired value. Press the  key to set the fourth digit.
		The setting procedure is complete and the unit returns to the normal display.

7.3.6 DATE (Measurement start date)

The **DATE** setting determines the measurement date and time output to the printer or computer with the measurement value.

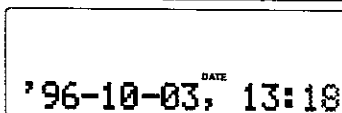
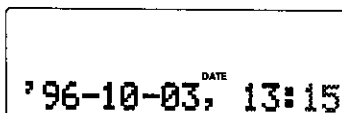
Although adjusted when shipped from the factory, this setting is performed when the built-in clock needs to be readjusted.

DATE (Measurement Date) Setting Procedure Example: Setting to 13:15:00, October 3, 1996

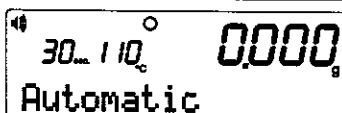
Operating procedure	Display	Explanation
 		Press the  key until the "DATE" indicator blinks. The current date and time is displayed. Press the  key to proceed to set the date and time.
  		The 2 year digits blink. Use the  and  keys to select the correct value. Press the  key to set the year.
  	 	The month position blinks. Use the  and  keys to select the correct value. Press the  key to set the month.
  	 	The day position blinks. Use the  and  keys to select the correct value. Press the  key to set the day.
  	 	The 2 hour digits blink. Use the  and  keys to select the correct value. Press the  key to set the hour.
  	 	The 2 minute digits blink. Use the  and  keys to select the correct value. Press the  key to set the minute. (The clock starts from 0 seconds when the  key is pressed.)
		The setting procedure is complete and the unit returns to the normal display.













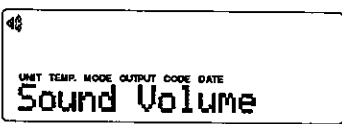











7.3.7 Setting the Measurement Complete Buzzer ()

The buzzer length and volume can be set.

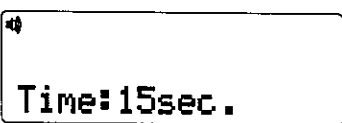
The sound volume can be set to either high or low.

The Time setting is used to set the buzzer time for 15 seconds or continuous. (Until the  key is pressed.)

Buzzer setting procedure Example: Setting to high volume, continuous tone.

Operating procedure	Display	Explanation
 		Press the  key until the buzzer  blinks. The current buzzer settings are displayed. Press the  key to proceed with buzzer settings.
  	 	Press the  key for low volume.  is displayed Press the  key for high volume.  is displayed Press the  key to set the volume.
  	 	Proceed to the time setting. The current time setting is displayed. Press the  key to set to a fixed period of 15 seconds. "15 Sec" is displayed at the bottom of the display. Press the  key to set to continuous tone. The  symbol appears and "Continue" is displayed at the bottom of the display. Press the  key to set the buzzer time.
		The setting procedure is complete and the unit returns to the normal display.

8. Measurement Procedures

Before beginning measurements, check to make sure that no material remains on the sample pan. Also check that all parts of the unit are stable. In particular check to make sure that the lamp cover is closed completely before proceeding with the measurement procedure.

① **Main unit horizontal readjustment (see page 12.)**

Check the built in level to confirm that the unit is horizontal.

② **Turn the power switch ON.**

③ **Make necessary settings.**

Make all setting necessary for the measurement.
(Refer to "Settings" on page 20 and "Data Output Settings" on page 42.)

④ **Install the tare (not used for normal measurements)**

When the sample characteristics require the use of aluminum sheets or sand tare, place on the sample pan.

⑤ **Perform zero point adjustment**

Open the lamp cover and press the  key.

⑥ **Place sample in the unit.**

Open the lamp cover and place the sample material in the unit.

The sample material should be spread out as evenly as possible.

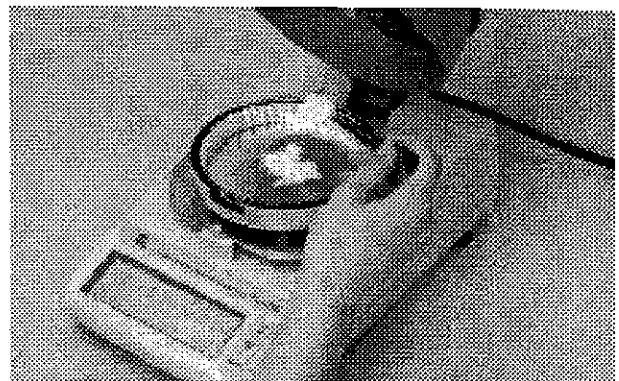
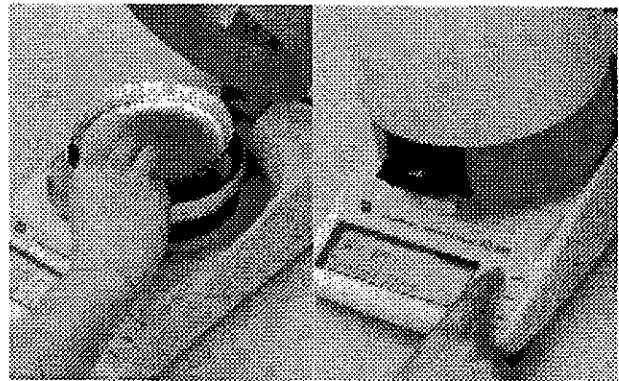
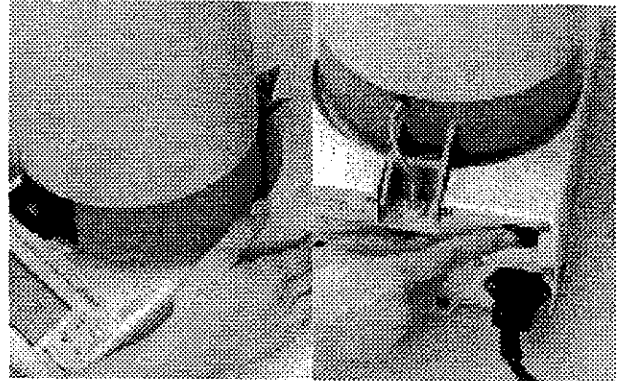

⑦ **Setting the initial mass (not required in normal measurements)**

To set the initial mass before beginning drying, open the lamp cover and press the **STOP** key when the scale stabilization symbol "O" is displayed. The mass is stored in memory and a "*" symbol is displayed. Perform this operation when the lamp cover is opened to even out the sample or when another unit is used to preheat the sample.

* Press the **RESET** key to delete this setting. The unit returns to the normal display.

⑧ **Begin measurement**

Close the lamp cover and press the **START** key. (Wait for the stabilization symbol "O" to be displayed before pressing.)

The mass display (g) switches over to the measured value display (%) and the infrared lamp lights. The temperature display switches from the set temperature to the current temperature.

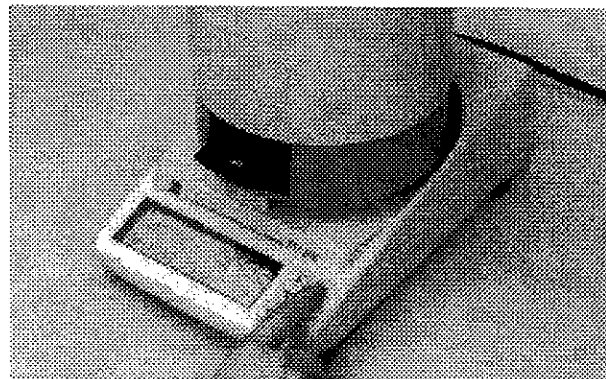

⑨ **Displaying the measurement process.**

The time displayed during measurement depends upon the measurement mode as follows:

Timed Measurement Mode : Time remaining (minutes) is displayed
Automatic Measurement Mode : } Time elapsed (minutes) is displayed
Predicted Measurement Mode : }

⑩ **Completing Measurement**

The buzzer sounds when the measurement process is complete.

The infrared lamp goes out and the hold mark "*" is displayed next to the measured value.

* Press the **STOP** key to stop a measurement manually.

⑪ **Reset**

Press the  key.

The displayed moisture content (%) switches to display the sample mass (g) and the unit is initialized for the next measurement.

⑫ **Removing the sample after measurement.**

Open the lamp cover, remove the sample pan using the sample pan gripper and dispose of the measured sample.

Note that the sample pan and sample material are hot.

Be sure to use the supplied sample pan gripper to remove the sample pan.

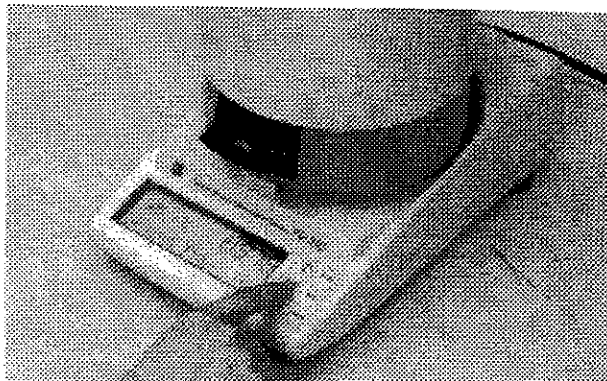

⑬ **Preparing for the next measurement**

Before beginning a new measurement, wait a minute or two to allow the entire unit to cool down or use a spare (cool) sample pan. (Please see page 37).

Begin the procedure again from step ③ or ④ as appropriate.

⑭ **Turn the power OFF**

Be sure to turn the power OFF after completing all measurements.

9. Notes Regarding Measurement

● When making continuous measurements

If sample material is placed on a heated sample pan some moisture may evaporate before the measurement is begun, thus resulting in inaccurate measurement results.

Be sure to use a cool sample pan before beginning the next measurement.

Also, try to maintain a fixed interval between measurements.

Measurement errors may result if the internal scale temperature is not constant.

● Using the sample pan and aluminum sheets

High precision measurement is not possible if residue from previous measurements remains in the sample pan.

Be sure to carefully clean any residue or soiling off the sample pan (see "14. Maintenance" on page 60) or use disposable aluminum sheets.

* Two sample pans are supplied with the unit as accessories.

* 20 disposable aluminum sheets are supplied with the unit as accessories.

● Quantities and loading of powdery, granular or particulate sample material

Samples are heated efficiently in proportion to their surface areas. Accurate measurements cannot be made if samples have bumpy surfaces with high points which are blackened by heating.

Sample material should be spread evenly in the pan. The larger the amount of sample the higher the measurement precision. However, measurement accuracy will degrade if the center of the sample is not dried before the surface is blackened by heating. Use the diagram below as a guide in spreading sample evenly in an appropriate quantity.



● Measuring liquid samples

With most liquid samples, material will be adhering to the sample pan after drying. In this case we recommend the use of the supplied aluminum sheets. These aluminum sheets are water compatible and samples spread well. They are also effective in shortening measurement time and improving measurement accuracy.

In addition, depending upon the type of sample, sand may be used to promote drying and the sheets are very effective in such cases.

(See "15. Consumibles and Optional Accessories" on page 66.)

- **Crush large grain samples before making measurements**

When measuring large grained samples, a long time may be required to dry the grains to the core and/or the surface may be blackened by heating before the cores are dried, thus resulting in inaccurate measurement values.

Crush samples to an appropriate size before performing measurements.

10. About the Predicted Measurement Mode

A large variety of sample materials are compatible with infrared moisture testers. This flexibility is an important characteristic not found in other types of moisture testers. However, because the infrared method involves heating a sample to evaporate off moisture content, some time is required to obtain results.

The Predicted Measurement Mode is provided to shorten the time required to obtain measurement results.

In the **Predicted Measurement Mode**, values obtained in the **Automatic Measurement Mode** are extrapolated to predict fluctuations and thus provide a predicted measurement value.

To use the Predicted Measurement Mode it is necessary to make **drying temperature, monitoring period, predicted value convergence range and compensation value** settings.

- **Drying temperature and monitoring period**

These settings are the same as the basic Automatic Measurement mode.

- **Predicted Value Convergence Range**

In the Predicted Measurement mode the predicted value is calculated repeatedly over time. A predicted value is considered to be established when fluctuations in these calculated values fall within a certain fixed range set beforehand. This range is referred to as the "predicted value convergence range".

The predicted value convergence range can be set from 0.1 ~ 9.9%.

The time required for measurement is shorter with larger convergence range values, but accuracy is lower.

Conversely, more time is required for measurement with smaller convergence range values, but accuracy is higher.

Set the predicted value convergence range as appropriate for your particular application. The initial value is 0.5%.

- **Compensation value**

The compensation value is used to correct measurement values in the automatic measurement mode and predicted measurement mode values.

This value can be set from 9.99% to 19.99%. The compensation value is obtained by following the comparison measurement procedure described below.

- * The compensation value is obtained using wet-base moisture content mode. Therefore, with dry-base moisture mode the compensation value will not strictly be the difference between the actual measurement value (obtained in the Automatic Measurement mode) and the predicted value.

● **Comparison measurement**

The Predicted Measurement Mode is divided into two parts, the **Comparison Measurement** which is performed to obtain the compensation value described above and the **Predicted Value Measurement** which is used to obtain the actual predicted value.

During the comparison measurement the predicted value is displayed. When the Automatic Measurement Mode on which this mode is based is complete the difference between the actually measured value and the predicted value is displayed as a compensation value.

To obtain more precise results, perform the comparison measurement procedure 5 times or more and take the average of the results as the compensation value.

Be sure that the quantity of sample and way in which it is placed on the sample pan are as close as possible.

● **Predicted Measurement**

The Predicted Measurement is actually performed by making the same drying temperature and monitoring period settings as in the basic Automatic Measurement mode, setting the predicted value convergence range and compensation value obtained in the comparison measurement described above.

If the predicted measurement value cannot be determined before the measurement ends, the measured value determined in the same way as with the Automatic Measurement Mode is displayed.

- * Depending on the type of sample, it may not be possible to perform predicted measurements with practically useful accuracy.

The following chart shows the predicted measurement mode procedure.

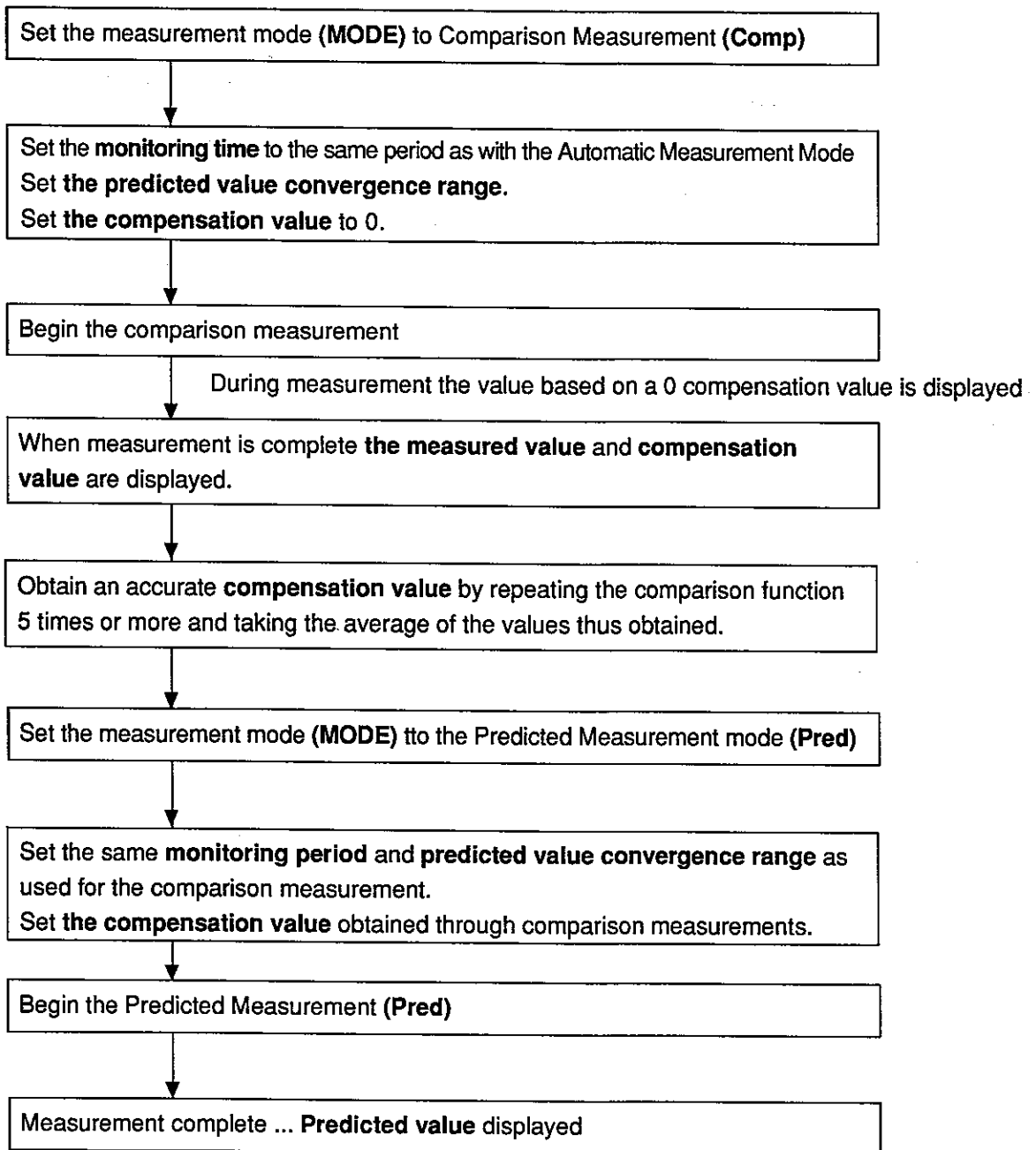

11. Data Output Settings

Measurement data can be output by connecting the AD-4715 to an optional printer or computer.

Information which can be output includes measurement data such as measurement process information and measurement results as well as sample codes and the measurement date and time.

11.1 Output Format Selection (OUTPUT)

There are 4 types of data output formats.

First select the desired format type.

Type	Display During Setting	Description
Off	OFF	No output
Computer	Computer	Numeric measurement process and measurement results data output to a computer.
Print-Table	Print-Table	Table measurement process and measurement results output to a printer.
Print-Graph	Print-Graph	Graphs of measurement process and results output to AD-8120

11.2 Output Interval Setting (Interval)

When any output format other than OFF is selected, the display next proceeds to the output interval setting. The output interval determines the interval at which measurement process data is output.

The 10 interval settings shown in the chart below are available.

If it is not necessary to output data while measurements are in progress, set to **Final** and data will only be output when the measurement process is completed.

Output Interval	Display
Every 10 seconds	10 sec
Every 30 seconds	30 sec
Every minute	1 min
Every 5 minutes	5 min
Every 10 minutes	10 min
Every 30 minutes	30 min
Every hour	1 hour
Every 2 hours	2 hour
Every 6 hours	6 hour
At the end of measurement only	Final

11.3 Graph Range Setting (Graph)











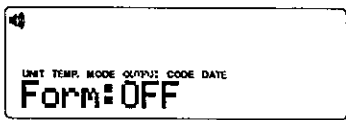



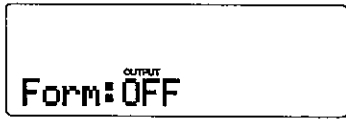

This setting determines the graph range used when the Print-Graph output mode is selected. As shown in the chart below, the upper and lower limits of the range are set as desired.

Measurement Standard	Graph Range
Wet-base moisture (%) solid component (%)	0 ~ 100% upper and lower set as desired in 5% increments
Dry-base moisture (%)	0 ~ 500% upper and lower set as desired in 5% increments

11.4 Output Format Setting Example (OUTPUT)

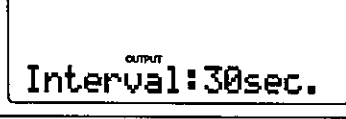
OUTPUT (output format) setting procedure

Example 1: Output to printer in chart format, output data at 30 second intervals

Key operations	Display	Explanation
<p>SELECT</p> <p>ENTER</p>		<p>Press the  key until the "OUTPUT" blinks. The current output format is displayed. Press the  key to make OUTPUT settings.</p>
<p>TARE </p> <p>RESET </p> <p>ENTER</p>	 	<p>Press the  or  key until "Form:Print-Table" is displayed. Press the  key to proceed to setting the output interval.</p>
<p>TARE </p> <p>RESET </p> <p>ENTER</p>	 	<p>Use the  and  keys to set the numeric value. Press the  key to set the output interval.</p>
		<p>The setting procedure is complete and the display returns to normal mode.</p>

OUTPUT (output format) setting procedure

Example 2 : Output to printer in graph format, output data at 30 second intervals, set graph range to 10 ~ 30%.

Key operations	Display	Explanation
<p>SELECT</p> <p>ENTER</p>		<p>Press the key until the "OUTPUT" blinks.</p> <p>The current output format is displayed.</p> <p>Press the key to make OUTPUT settings.</p>
<p>TARE </p> <p>RESET </p> <p>ENTER</p>	 	<p>Press the or key until "Form:Print-Graph" is displayed.</p> <p>Press the key to proceed to setting the output interval.</p>
<p>TARE </p> <p>RESET </p> <p>ENTER</p>	 	<p>Use the and keys to set the numeric value.</p> <p>Press the key to set the output interval.</p>
<p>TARE </p> <p>RESET </p> <p>ENTER</p>	 	<p>The graph range is displayed. The value on the left is the lower limit and the value on the right is the upper limit. First The lower limit value is blinking.</p> <p>Use the and keys to set the numeric value.</p> <p>Press the key to set the lower limit and proceed to set the upper limit.</p>
<p>TARE </p> <p>RESET </p> <p>ENTER</p>	 	<p>Use the and keys to set the numeric value.</p> <p>Press the key to set the upper limit.</p>
		<p>The setting procedure is complete and the display returns to normal mode.</p>

11.5 Printer Output Example (Various types of measurement settings and printer output examples)

Output Example 1: Output format : Print-Graph
 Output interval : Every 30 seconds
 Graph range : 0 ~ 20%

① Sample Code : A001
 ② Date/Time : 96-05-20/16:56
 ③ Condition Number : 0
 ④ Setting Temperature : 110°C
 ⑤ Mode : Automatic : 30sec.
 Wet Mass : 5.092g

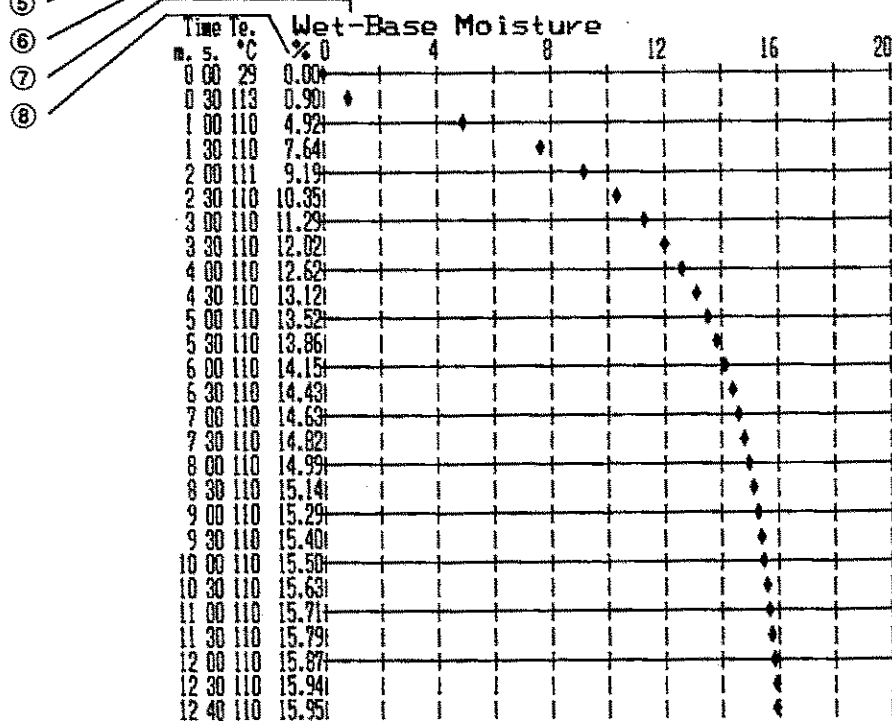

⑨ Dry Mass = 4.280g

① Sample Code : A001
 ② Date and Time : 16:56, May 20, 1996
 ③ Measurement condition area : 0 (optional area)
 ④ Drying temperature : 110°C
 ⑤ Measurement mode : Automatic measurement
 Monitoring period 30 seconds.
 ⑥ Initial mass : 5.092g
 ⑦ Measurement standard : Wet-base moisture (%)
 ⑧ Measurement standard : 0.01%
 ⑨ Mass after drying : 4.280g

Output Example 2: Output format : Print-Chart
 Output interval : Final only
 Measurement mode : Automatic measurement

Date : 96-05-21
 Condition Number : 0
 Setting Temperature : 130°C
 Mode : Automatic : 30sec.

Code	Time	Wet-Mass	Dry-Mass	Wet-Moist.
C001	11:46	5.133g	4.271g	16.80%
C002	13:06	5.178g	4.301g	16.94%
C003	13:30	5.166g	4.291g	16.94%
C004	13:51	5.191g	4.319g	16.80%
C005	14:29	5.223g	4.338g	16.94%

Output Example 3: Output format : Print-Chart
 Output interval : Once per minute
 Measurement mode : Timed Measurement mode (15 minutes)

Sample Code : D001
 Date/Time : 96-05-21/14:52
 Condition Number : 0
 Setting Temperature : 120°C
 Mode : Drying Time: 15min.

Time	Temp.	Mass	Wet-Base Moist.
0m00s	44°C	5.056g	0.00%
1m00s	121°C	4.783g	5.40%
2m00s	120°C	4.551g	9.99%
3m00s	121°C	4.436g	12.26%
4m00s	120°C	4.368g	13.62%
5m00s	120°C	4.323g	14.49%
6m00s	120°C	4.290g	15.16%
7m00s	120°C	4.269g	15.58%
8m00s	120°C	4.251g	15.92%
9m00s	120°C	4.240g	16.15%
10m00s	120°C	4.231g	16.33%
11m00s	120°C	4.220g	16.53%
12m00s	120°C	4.213g	16.67%
13m00s	121°C	4.207g	16.79%
14m00s	120°C	4.203g	16.88%
* 15m00s	120°C	4.199g	16.95%

Output Example 4:

Output format : Print-Graph
 Output interval : Every 30 seconds
 Graph range : 0 ~ 20%
 Measurement mode : Comparison measurement
 Monitoring period 40 seconds
 Predicted value convergence range 0.5%
 Compensation value 0%

Sample Code : E001
 Date/Time : 96-05-22/10:16
 Condition Number : 0
 Setting Temperature : 120°C
 Mode : Comparison : 40sec.
 Wet Mass : 5.214g

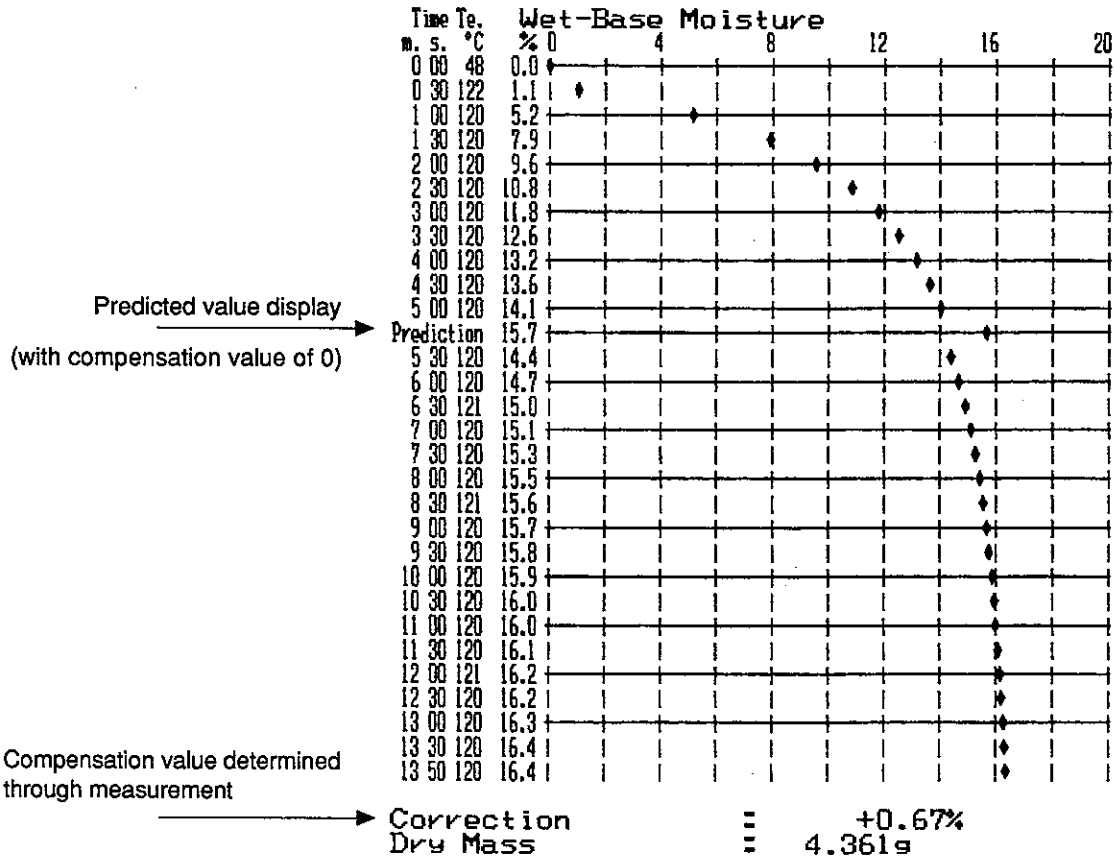

11.6 Computer Output Format

Numeric values are right-justified ASCII code numbers.

Measurement values are output following the title

11.6.1 Title

The title is output in the following sequence:

"_" is a space character, "CR" is the carriage return code, "LF" is the line-feed code.

Each item is separated by a "," code and a CRLF sequence marks the end of the title.

Item	Number of bytes	Example	Supplemental information
Sample code	4	"L.73"	2 digits (letters) + 2 digits (numbers)
Measurement start time	14	"96,02,24,15,07"	Year, month, day, hour, minute
Measurement condition number	1	"2"	0 ~ 9 0 is the optional area, 1 ~ 9 are registered areas
Measurement standard	16	"Wet-Base Moist."	Same as the display during key settings.
Set temperature (°C)	3	"200"	
Measurement mode	1	"A"	Timed Measurement Mode : "T" Automatic Measurement Mode : "A" Predicted Measurement Mode : "P" Predicted Measurement Mode Comparison Measurement : "C"
Measurement Mode Internal Settings	3	"_60"	Drying time in the Timed Measurement mode (minutes) Monitoring period in the Automatic and Predicted measurement modes (seconds)
Total	50		Including comma separators and terminating CRLF sequence.

11.6.2 Measurement Process

The following items are output repeatedly at the set interval.

The individual items are separated by commas and each batch of data is terminated with a CRLF sequence.

During predicted measurement mode comparison measurements, predicted values are output with data number 9100 when predictions are calculated during the measurement process.

Item	Number of bytes	Example	Supplemental information
Data Number	4	"__ _1"	The initial data number when measurement begins is 0.
Elapsed time (minutes and seconds)	6	"_36.00"	
Temperature (°C)	3	"105"	
Mass (mg)	6	"_ _5025"	
Measured value	6	"_14.04"	The 6th byte is a space character when the minimum digit is set to 0.1%.
Total for 1 data batch	31		Including separating commas and the terminating CRLF sequence.

11.6.3 Measurement Results

- The final data output when measurement is complete is given data number 9000.
- Predicted values calculated during predicted measurement mode are output with data number 9100 *1.
- During comparison measurement in the predicted measurement mode, after the final data the compensation value is output with data number 9101 *2.

* *1.*2 No data is output if a prediction cannot be made during the Predicted Measurement Mode.

12. Communications with Computers

The AD-4715's RS-232C interface allows it to communicate with a connected computer which also has a RS-232C interface. The AD-4715 can transmit data to the computer and the computer can be used to control the AD-4715.

12.1 RS-232C Interface Specifications

Standard : EIA-232E standard serial interface
Sync format : synchronous
Baud rate : 2400bps
Data bits : 8 bits
Parity bits : None
Stop bits : 1 bit
Character codes : ASCII
Connector : D-sub 9 pin male
Pin arrangement :

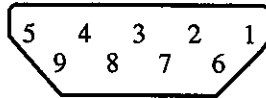

Pin Number	Direction	Function
1		Not connected
2	Output	Transmit data
3	Input	Receive data
4	Output	Power ON
5		GND
6		Not connected
7	Output	Communications enabled
8		Not connected
9		Not connected

12.2 Communications Standards and Format

Please follow the instructions provided with the personal computer and software being used for information about preparing the computer for communications and communication methods.

- ① Turn the AD-4715's power switch OFF.
- ② Connect the computer and AD-4715 with a RS-232C cable

Connect the 9-pin male connector into the AD-4715's RS-232C connector and secure it with screws on both sides so that it will not come loose. Next, connect the other end of the cable to the computer's RS-232C connector in the same manner.

Readjust the level of the AD-4715 if it is moved while making these connections. (See "4. Getting Started (Unit assembly and installation)" on page 12)

- ③ Turn on the AD-4715's power supply switch and make settings for data output if necessary.
- ④ Turn on the computer, start the operating system, set the RS-232C interface protocol to match the AD-4715 and then run your communications software to enable communications.
 - The white space character " " represents the hex value 0x20.
 - "CR" represents the carriage return character (hex value 0x0D).
 - "LF" represents the line feed character (hex value 0x0A).
 - "NK" represents the reject code (hex value 0x15).

12.3 Command Control

The AD-4715 can be controlled by commands sent from a computer or other device.

Commands begin with a 1-byte command followed by a "CRLF" sequence.

Two types of commands are distinguished: Setting Commands which make measurement settings and Execute Commands which perform actions such as starting and stopping measurements.

12.3.1 Types of Commands

● Setting Commands

- Setting commands consists of a command followed by multiple parameters separated by commas.
- When parameters are numeric values, numeric strings from "0" ~ "9" are used.
- The number of bytes per parameter must be within the maximum number of digits. If within the maximum, the value may have a space character attached.
- The ones position, zeros below the decimal point and positive and negative "+" and "-" signs cannot be omitted.
- Refer to the list of Settings Commands regarding the commands, meanings of parameters and allowable ranges.
- Parameters can be omitted, in which case the corresponding setting is not changed.
- Commands are not accepted during measurement or during key settings.
- The command is returned when received correctly.
- Parameters are output right-justified with the number of bytes equal to the number of digits of the largest value.
- Even if parameters are omitted, the current values are returned so that the settings can be confirmed.

● Execute Commands

- Execute commands are not accepted when they cannot be executed.
- If accepted correctly the corresponding action is executed. In some cases data is transmitted back or the command is returned.
- When transmitting multiple commands, they may not be executed correctly if no time interval separates them.
- Either provide a sufficient time interval between commands or delay transmission of following commands until the command response is received.

12.3.2 List of Settings Commands

Type	Command and Parameters	Description	
Settings Condition Number	N, settings condition number	Sets the measurement condition area (0 ~ 9). 0 is the optional area, 1 ~ 9 are registered areas.	
Measurement standard	U, W U, D U, P	Set the unit to wet-base moisture percentage Set the unit to dry-base moisture percentage Set the unit to solid component percentage	
Measurement value, minimum digit	L, minimum digit after decimal point	Set the minimum measurement value digit after decimal point. Set to 1 or 2.	
Drying temperature	T, temperature (°C)	Set the heating and drying temperature (0 ~ 200°C)	
Measurement Mode	Timed Drying	M, T, drying time (minutes)	Set the measurement mode to Timed Measurement and the drying time (1 ~ 999 minutes)
	Automatic	M, A, monitoring period (seconds)	Set the measurement mode to Automatic Measurement and the monitoring period (10 ~ 300 seconds in 10 second increments)
	Predicted Measurement (Prediction)	M, P, monitoring period (seconds) Predicted value convergence range (%), compensation value	Set the measurement mode to Predicted Measurement Mode, set the monitoring period (seconds), predicted value convergence range (0.1 ~ 9.9%), and compensation value (-9.99 ~ +9.99).
	Predicted Measurement (Comparison)	M, C, monitoring period (seconds) Predicted value convergence range (%), compensation value	Set the measurement mode to Predicted Measurement Mode, set the monitoring period (seconds), predicted value convergence range (0.1 ~ 9.9%), and compensation value (-9.99 ~ +9.99).
Measurement Complete Buzzer	B, volume, time	Set the buzzer volume (0: low, 1: high) and time (0 : 15 seconds, 1: continuous)	
Measurement data output	O, O	Set the measurement data output format to OFF.	
	O, C, time interval	Set the measurement data output format to computer and set the time interval.	
	O, T, time interval	Set the measurement data output format to printer-chart and set the time interval.	
	O, G, time interval, graph lower an upper limits (%)	Set the measurement data output format to printer-graph, set the time interval and set the upper and lower limits of the graph range.	
Sample Code	C, sample code	Set sample codes with first 2 digits using "0" ~ "9", "A" ~ "A". " ", and "_". Last two digits are numeric values.	
Date and Time	D, year, month, day, hour, minute	Set the date and time. The year is set with the trailing two digits of the year.	

12.3.3 Executable Commands

= Tare Command

This command is used to perform the tare operation (zero point adjustment) during normal operation (while the mass is not being held).
If the tare operation is completed correctly, the command "=" with terminating CRLF sequence is echoed back.

[Start Measurement Command

Normally, this command starts measurement if the weight is above 0 and measurable.

] Stop Measurement Command

This command is used to stop measurement.
When measurement stops the buzzers sounds and the "]" command and terminating CRLF sequence is echoed back.

/ Reset Command

After measurement is complete the unit is reset and returns to its normal state, and the "/" command and terminating CRLF sequence is echoed back.

H Mass Hold Command

Under normal conditions (when the mass is not being held) and the mass is greater than 0 and within the measurable range, the mass is held and the "H" command and CRLF sequence is echoed back.
NKCRLF is returned if the mass is zero or exceeds the measurable limit.

R Release Mass Hold Command

Releases the mass hold and echoes back "R" and the terminating CRLF sequence.

W Mass Transmission Request Command

Under normal conditions, the mass is returned in the following format:
State (Stable : S, Unstable : U, Within scale range : 0, Hold : *)
Mass (in mg, 6 digit numeric string) CRLF

V Measurements Results Transmission Request Command

When measurements are not in progress, the results from the last measurement after the power was turned on is transmitted.
The measurement results output format is shown on the following page.
Items are separated by commas and a CRLF sequence marks the end.

Item	Number of bytes	Example	Supplemental info
Sample code	4	" L-73 "	2 digits (character) + 2 digits (numeric)
Measurement Started Date and Time	14	" 96,02,24,15,07 "	Year, month, day, hour and minute
Measurement Conditions Area	1	0 ~ 9	0~9 0 is the optional area, 1 ~ 9 are registered areas.
Units	16	" Wet-Base Moist._ "	Same as displayed during key settings
Set temperature (°C)	3	" 200 "	
Measurement mode	1	" A "	"T" for timed measurement mode, "A" for automatic measurement mode, "P" for predicted measurement mode, "C" for comparison measurement mode.
Measurement mode internal settings	3	" _60 "	The drying time (in minutes) for the timed measurement mode, or the monitoring period (in seconds) for the automatic measurement mode and predicted measurement mode (predicted measurement and comparison measurement).
Measurement time	6	" _36,20 "	Minutes, seconds
Total weight (mg)	6	" __4997 "	
Dry weight (mg)	6	" __4519 "	
Measured value (%)	6	" _90.41 "	The 6th byte is a space character if the minimum digit is set to 0.1%. In the predicted measurement mode this is the predicted value.
Total	78		Including CRLF and "," separators.

13. Using the Printer (Optional)

The AD-4715 infrared moisture balance can be connected to the specially designed model AD-8120 printer to print out data in a format set on the main unit.

The AD-8120 is a thermal-type printer which uses heat sensitive printer paper. It can be powered either by an AC adapter (6V) or by internal rechargeable batteries. (Approximately 1500 lines of data can be printed when the batteries are fully charged and the AC adapter is disconnected.)

* Also please refer to the AD-8120 Manual.

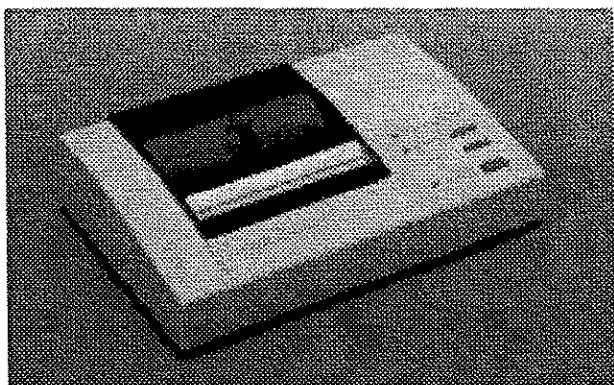

13.1 Setting DIP Switches

DIP switches located on the bottom of the unit are used to set the printer's initial state. These switches must be set as indicated in the diagram below before the printer can be used.

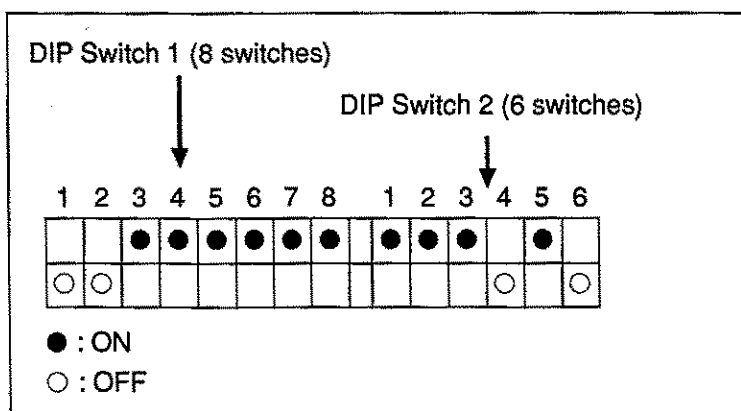

▲ DIP Switch Settings

13.2 Connection to the Main Unit and Print Out

① Place the unit on a flat, stable surface.

② Turn off the power of both the AD-4715 and the printer.

Be sure to turn off the power of both the AD-4715 and the printer before connecting them.

③ Insert the cable plug into the connectors.

The printer has two input connectors. Plug the cable into the upper serial input connector. The plug cannot be inserted if oriented incorrectly. Check to make sure that it is oriented correctly.

Tighten the screws on both sides of the connector so that it does not come loose.

④ Turn on the AD-4715.

Turn on the AD-4715 before turning on the printer.

After connecting to the printer, check the unit's level and adjust if necessary.

⑤ Set the printer to the on-line mode

Press the on/off-line switch to set the printer to the on-line mode. (The green on-line LED lights.)

⑥ Measurement and printout

Data is output from the main unit in the specified format when drying begins.

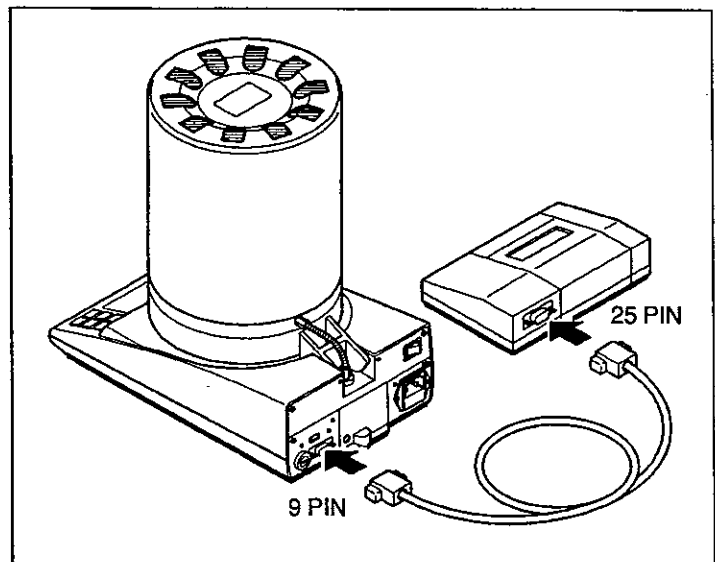

▲ Insert the plug in the correct orientation.

14. Maintenance

14.1 Performing User Maintenance



Turn the unit's power off and remove the plug from the outlet.

① Removing accessories

The sample pan, sample pan support, wind shield and reflector plate can be removed in that order.

② Installing accessories

Please refer to page 12, "4. Getting Started (Unit assembly and installation)".

③ Remove and spilled sample material, etc.

④ Main unit maintenance

- Remove dirt with a soft cloth.
- Do not rub strongly even if dirt does not come off easily.
- If dirt does not come off easily, use a soft cloth wet with water or a neutral cleanser, squeeze out excess and wipe.

⑤ Maintenance of Accessories

- Use a soft sponge to clean the spoons, spatulas, sample pans and wind shield and reflector plate (removed from unit).
- Do not reinstall into the unit or use until completely dry.

⑥ Notes



- Please refer to item ④ above when using a detergent.



- Do not use volatile chemicals such as benzene or paint thinner and do not use detergents which contain abrasives.



- Do not use metal brushes or steel wool.

14.2 Replacing the Infrared Lamp (Please refer to page 13)

- ① Turn the power switch OFF.
- ② Open the lamp cover.
- ③ Grip the protruding part on the left side of the temperature sensor housing and pull the temperature sensor down.
- ④ Remove the infrared lamp screwed into the lamp cover.
- ⑤ Screw in a new infrared lamp.
- ⑥ Return the temperature sensor to its original position. (A click will be heard when it is fixed in place.)

Use an infrared lamp compatible with the power supply voltage you are using.

14.3 Replacing the Fuse



- ① Turn the power switch OFF and remove the power supply cord from the outlet.
 - ② There are two fuse holders (main and sub).
Do not mix the two types of fuses.
Use a standard screwdriver or other tool to pull out the fuse holder.
To remove the sub fuse holder, use the screwdriver to turn it to the right and then pull it out.
To remove the main fuse holder, use the screwdriver tip to pull up the top and then pull out.
 - ③ Remove the fuses and check to see if they are blown.
 - ④ If not blown, return them to the holder. If they are blown, replace them with the spare fuses supplied or fuses meeting the ratings indicated on page 11.
 - ⑤ Reinstall the fuses as they were.
Press the sub fuse holder firmly down to its original position and turn right to lock.
Press the main fuse holder firmly down to its original position.
 - ⑥ Plug the power supply cord connector into the unit.
- * If the fuse blows again after being replaced there may be some problem with the unit. Please have it inspected and repaired if necessary.



A&D Company, Limited

3-23-14 Higashi-Ikebukuro, Toshima-ku, Tokyo 170 JAPAN
Telephone: [81] (3) 5391-6132 Fax: [81] (3) 5391-6148

A&D ENGINEERING, INC.

1555 McCandless Drive, Milpitas, CA. 95035 U.S.A.
Telephone: [1] (408) 263-5333 Fax: [1] (408)263-0119

A&D INSTRUMENTS LTD.

Abingdon Science Park, Abingdon, Oxford OX14 3YS ENGLAND
Telephone: [44] (1235) 550420 Fax: [44] (1235) 550485

<German Sales Office>

Genfer Strasse 6, Niedereschbach 60437 Frankfurt Main 50 GERMANY
Telephone: [49] (69) 507-1017 Fax:[49] (69) 507-2054

A&D MERCURY PTY. LTD.

32 Dew Street, Thebarton, South Australia 5031 AUSTRALIA
Telephone: [61] (8) 352-3033 Fax: [61] (8) 352-7409

A&D KOREA Limited

8th Floor, Manhattan Bldg. 36-2 Yoido-dong, Youngdeungpo-ku, Seoul, KOREA
Telephone: [82] (2) 780-4101 Fax: [82] (2) 782-4280