

# FS/FS-KL SERIES

WATERPROOF CHECK WEIGHING SCALES

## INSTRUCTION MANUAL

---

Instruction-FS/FS-KL-v.1.a 92.11.11

INDUSTRIAL DUAL RANGE SCALES

**AND**  
A&D Company, Limited



# Table of Contents

Compliance with FCC Rules .....	page iii
<b>Section A • Set-Up</b> .....	page A • 1
Unpacking Your Scale .....	page A • 2
Assembling Your Scale.....	page A • 4
Fitting Batteries .....	page A • 7
Connecting the A.C. Adaptor.....	page A • 8
Security of Your Scale.....	page A • 9
Switching the Scale ON.....	page A • 9
<b>Section B • Introduction</b> .....	page B • 1
Welcome .....	page B • 2
Features .....	page B • 2
Specifications.....	page B • 3
Dimensional Outline Drawing.....	page B • 5
Description of Front Panel .....	page B • 6
Description of Key Operations .....	page B • 8
Changing the Weighing Mode.....	page B • 11
<b>Section C • Calibration</b> .....	page C • 1
About Calibration.....	page C • 2
Calibration Procedure .....	page C • 2
Gravity Compensation.....	page C • 3
Zero and Span Calibration.....	page C • 4
Zero Calibration.....	page C • 4
Span Calibration .....	page C • 5
Calibration Messages.....	page C • 6
<b>Section D • Simple Weighing Mode</b> .....	page D • 1
Simple Weighing.....	page D • 2
Simple Weighing with Tare .....	page D • 4
To Clear a Stored Tare.....	page D • 5
Error Messages.....	page D • 6
<b>Section E • Limit Check Weighing Mode</b> .....	page E • 1
Limit Check Weighing Mode .....	page E • 2
<b>Section F • Target Weighing Mode</b> .....	page F • 1
Target Weighing Mode.....	page F • 2

<b>Section G • Comparator</b> .....	page G • 1
Using the Comparator .....	page G • 2
Setting Target Weight by Key.....	page G • 2
Setting the HI Limit.....	page G • 3
Setting the LO Limit.....	page G • 4
Setting Target Weight by Sample .....	page G • 5
The Comparator Memory.....	page G • 6
Storing a Set of Limits in Memory .....	page G • 6
Recalling a Limit from Memory.....	page G • 8
<b>Section H • Function Settings</b> .....	page H • 1
Internal F-Functions .....	page H • 2
Changing the Function Settings.....	page H • 3
The F-Function Settings.....	page H • 4
F1 Comparator Condition.....	page H • 4
F2 Liquid Crystal Display .....	page H • 5
F3 LIMIT Sweep Display Magnification.....	page H • 5
F4 UNIT Selection (U.S.A. Only).....	page H • 6
F5 Automatic Power Down.....	page H • 7
F6 Front Panel Key Lockout.....	page H • 7
F7 Scale Response Speed.....	page H • 7
F8 Power ON Weighing Mode.....	page H • 8
F9 Serial Data Output Method.....	page H • 8
FA Serial Data Baud Rate .....	page H • 8
Fb Comparator Buzzer.....	page H • 9
FC Analog Sweep Display Mode .....	page H • 9
<b>Section I • OP-03 RS232 Option</b> .....	page I • 1
OP-03 Installation.....	page I • 2
Specifications.....	page I • 4
Data Format.....	page I • 5
Data Output Method.....	page I • 5
Command Mode.....	page I • 6
Comparator Output Relays .....	page I • 8

<b>Appendix AP 1</b> .....	page AP•1
Additional Cal. & Gravity Info.....	page AP•2
Gravity Compensation .....	page AP•2
Gravity values at various locations.....	page AP•3
Acceleration due to Gravity table.....	page AP•3
World Map.....	page AP•4



## Compliance with FCC Rules

Please note that this equipment generates, uses and can radiate radio frequency energy. This equipment has been tested and has been found to comply with the limits of a Class A computing device pursuant to Subpart J of Part 15 of FCC rules. These rules are designed to provide reasonable protection against interference when equipment is operated in a commercial environment. If this unit is operated in a residential area it might cause some interference and under these circumstances the user would be required to take, at his own expense, whatever measures are necessary to eliminate the interference.

(FCC = Federal Communications Commission in the U.S.A.)

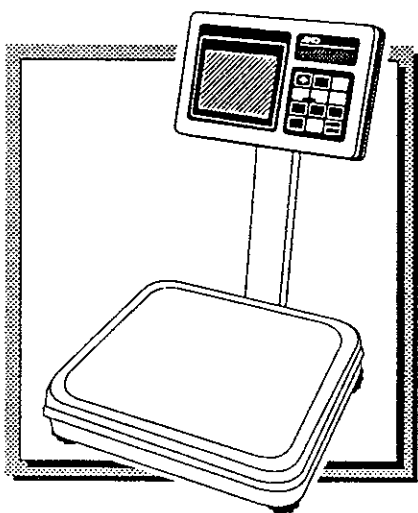

## FS/FS-KL Series • Section A

# Set-Up



# Unpacking Your Scale



*Unpack the scale carefully and keep the packing material if you are likely to transport the scale again in the future.*

- ▶ In the carton you should find this manual plus:
  - The Pan, Indicator and Column in disassembled form.
  - The column support bolts (2). (FS Series)  
A set of bolts. (FS-KL Series)
  - Open ended wrench. (FS Series)  
Hexagonal wrench. (FS-KL Series)
  - **Batteries** : 6 x C cell in FS/FS-KL - A type scales.
  - **A.C. adaptor** in FS/FS-KL - B type scales.

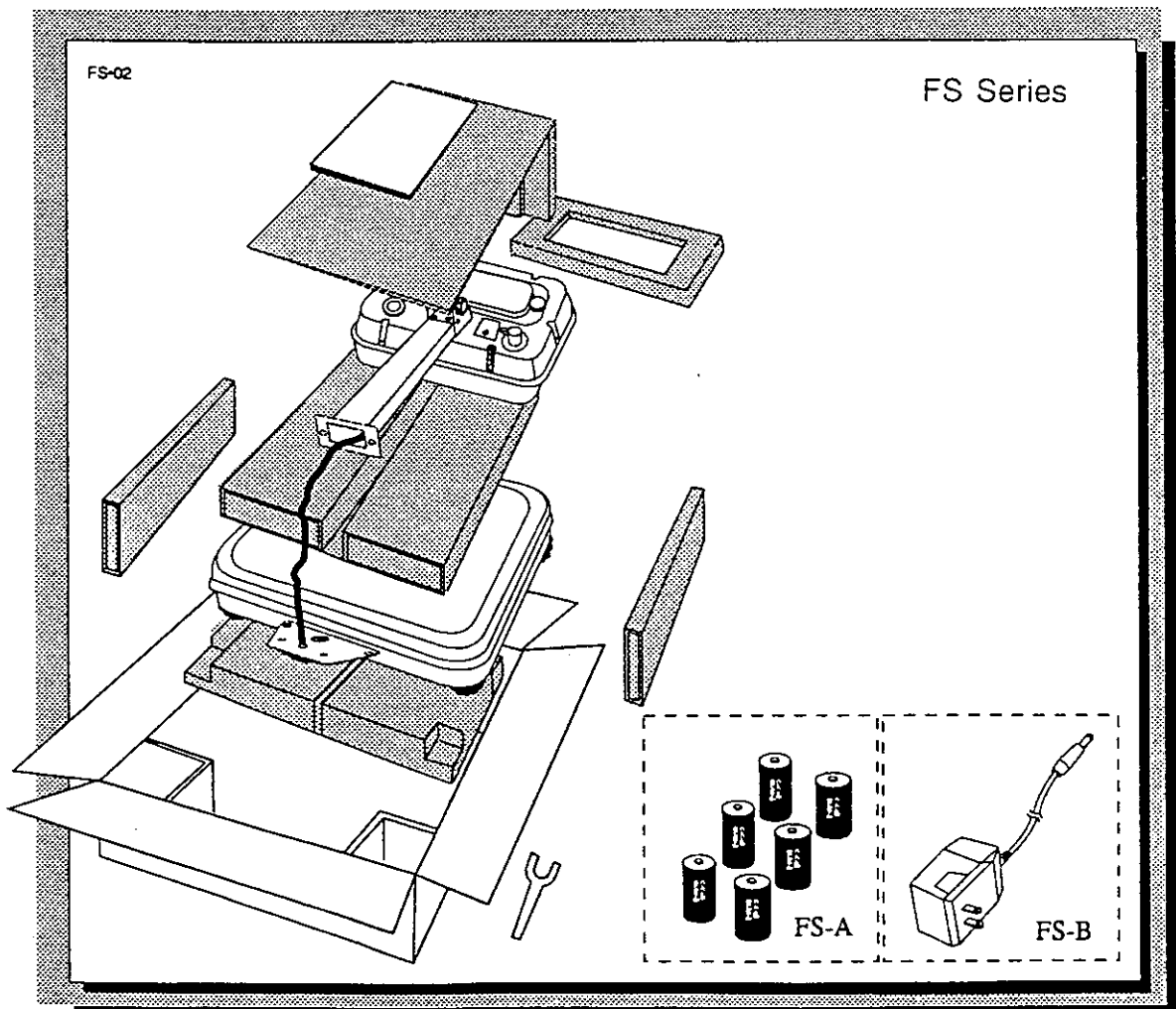

FS-KL Series

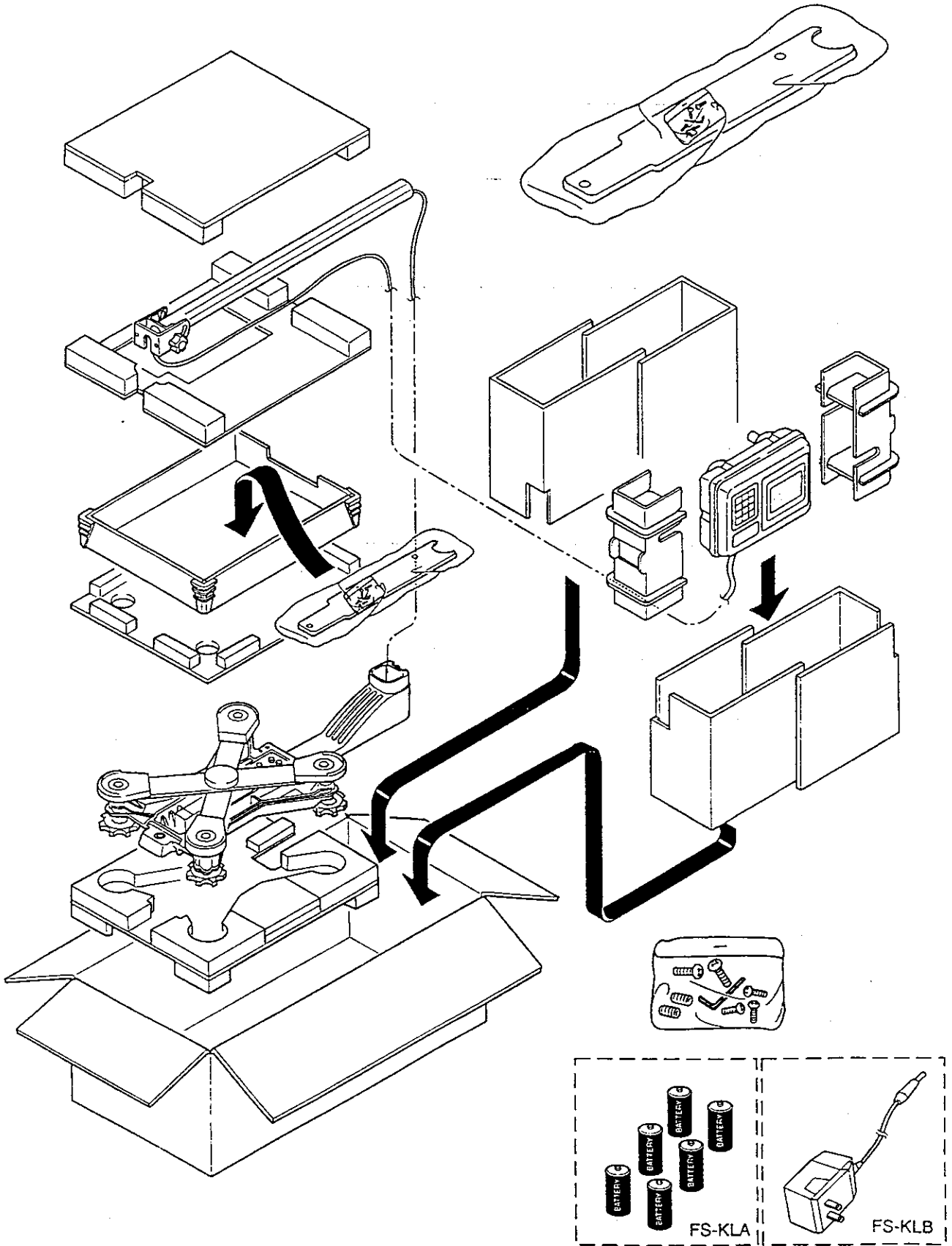





# Assembling Your Scale

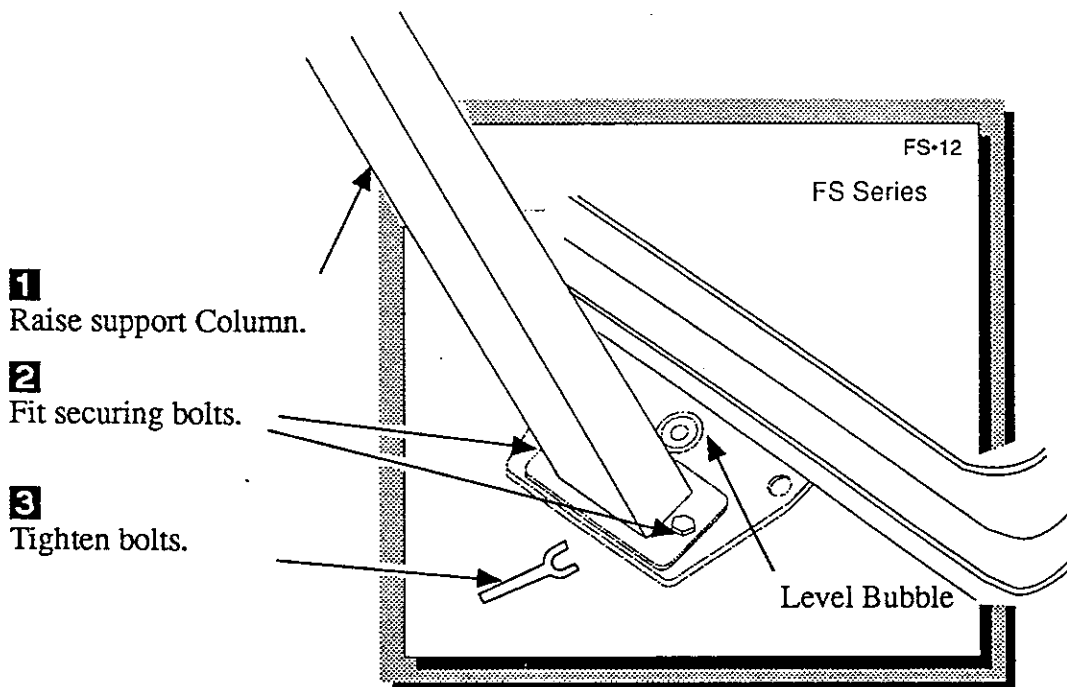

**1** Carefully raise the pod support column to the vertical position and feed any excess loadcell cable into the column.

**2** Secure the support column to the base using the 2 bolts.

**3** Tighten the bolts using the wrench provided in the box.

**4** After you have selected your weighing area and positioned your scale: adjust the five leveling feet until the bubble in the spirit level indicates the scale is level (do this every time the scale is moved).

FS-KL Series

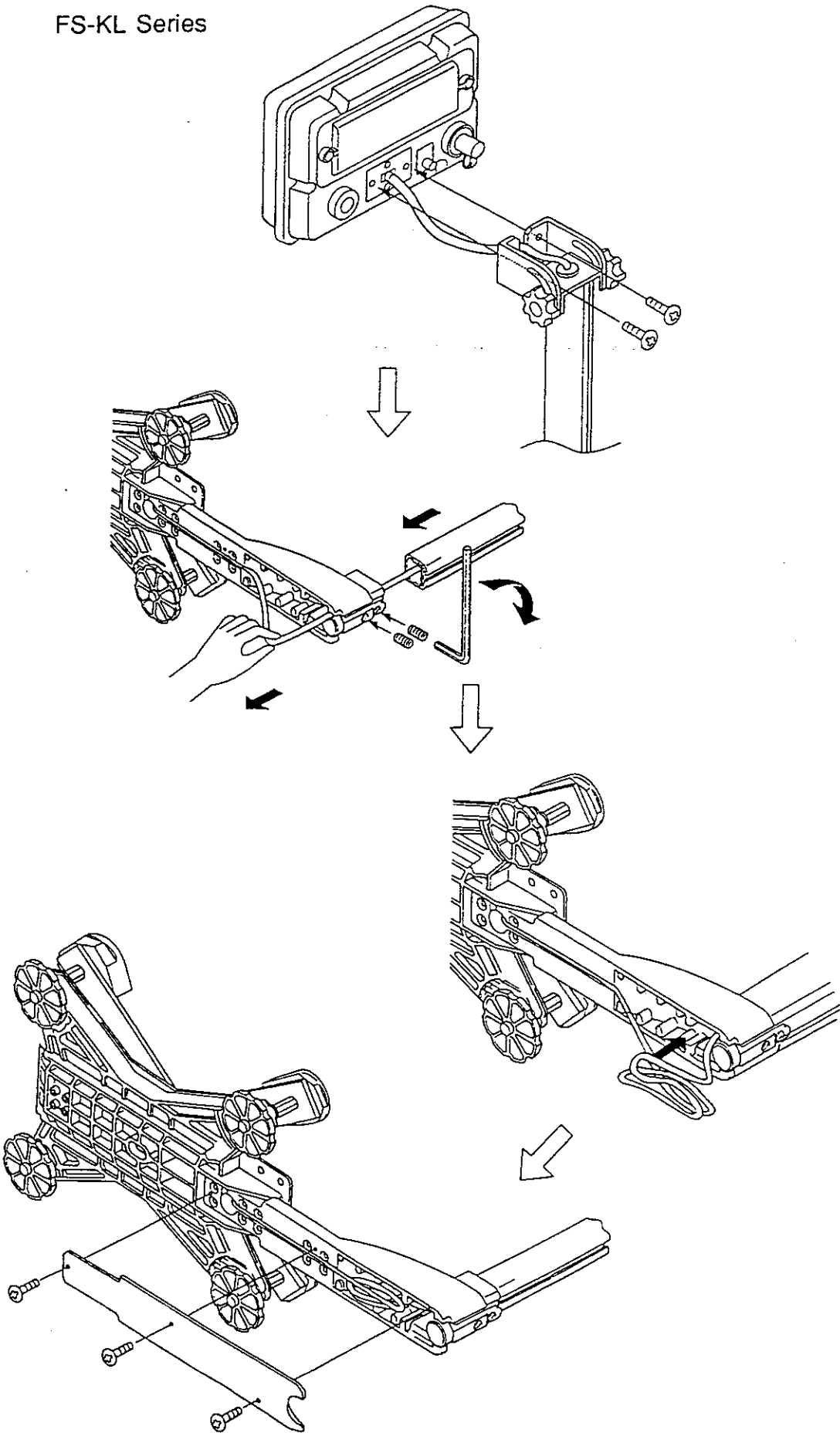

- 1** ▶ Mount the indicator to the pole bracket.

- 2** ▶ Put the extra cable into the under-pole bracket as indicated in the drawing.

- 3** ▶ Mount the bottom cover.  
(A Phillips-head screwdriver should be prepared by the customer.)

Turn the leveling foot at the four corners of the measuring pan until bubbles in the level gauge come to the center of the red circle.

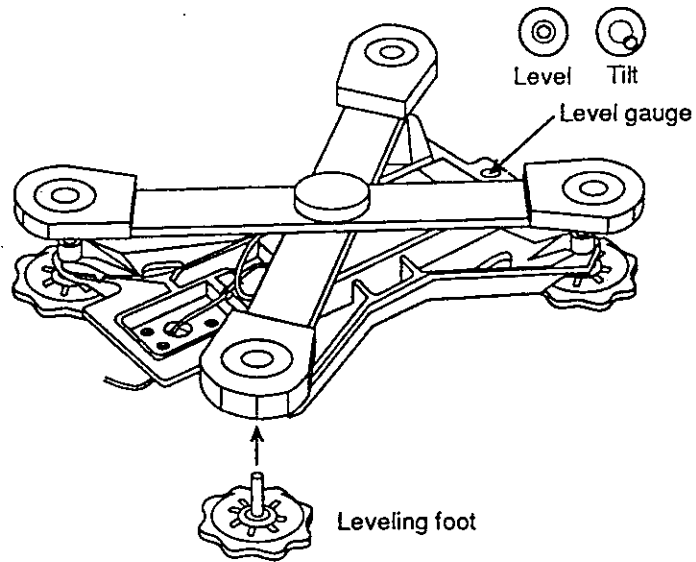

## Fitting Batteries

1

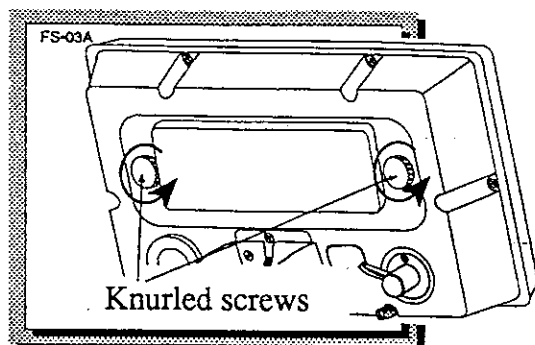

- ▶ Remove the battery compartment cover by undoing the 2 knurled securing screws and pulling the cover away from the rear of the display.

2

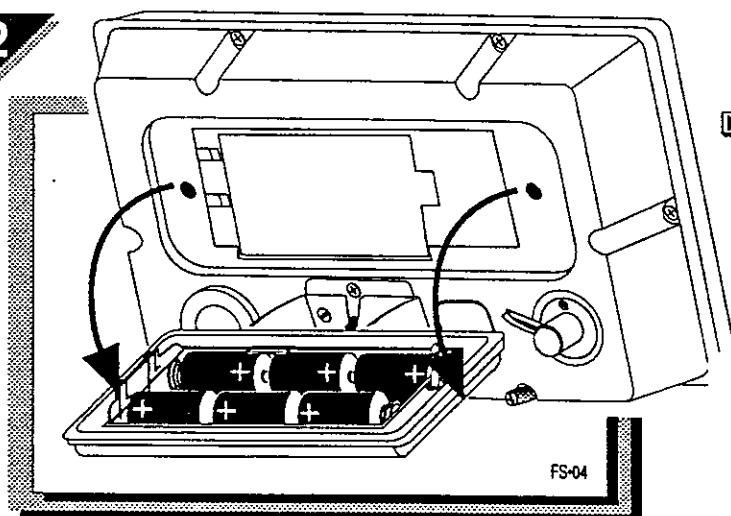

- ▶ Carefully fit the 6 x C cells into the carrier observing the correct polarity as marked inside the battery cover.

3

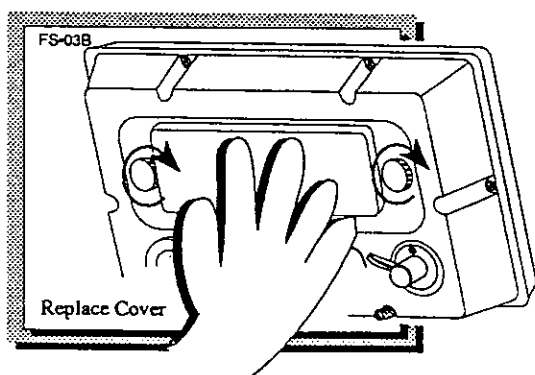

- ▶ Replace the cover and push home firmly.
- ▶ Tighten the 2 securing screws

## Connecting the A.C. Adaptor



Ensure that you have the correct input voltage adaptor for your mains supply.

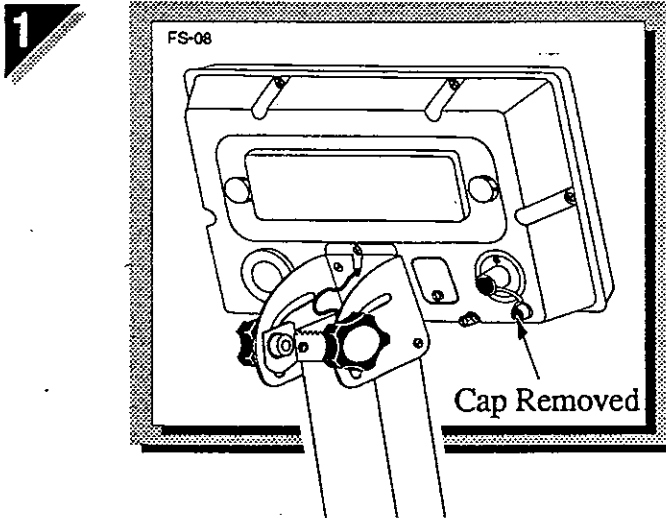

- ▶ Remove the cap, on it's retaining strap, from the end of the adaptor inlet grommet.

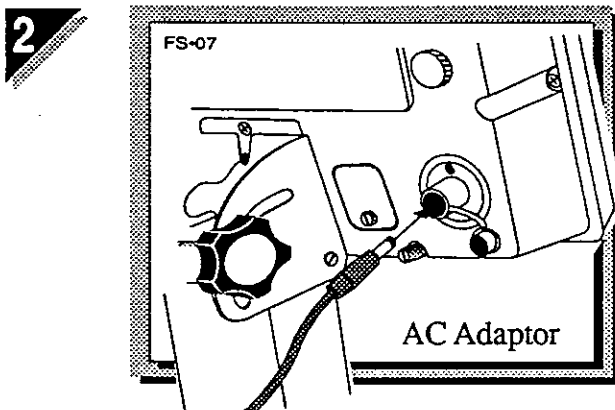

- ▶ Insert the adaptor lead into the grommet and push it firmly home into the socket.

# Security of Your Scale



FS-13

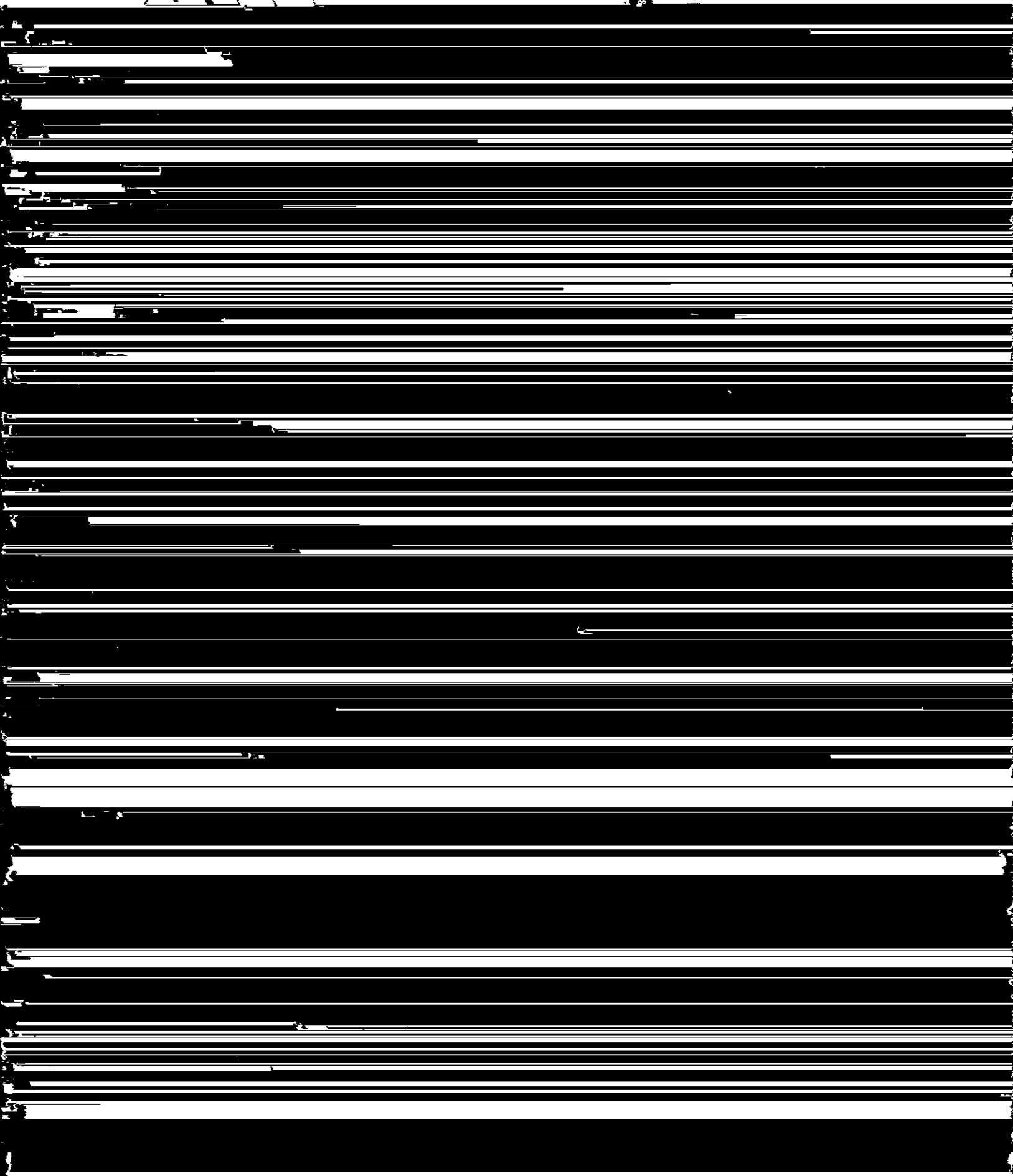

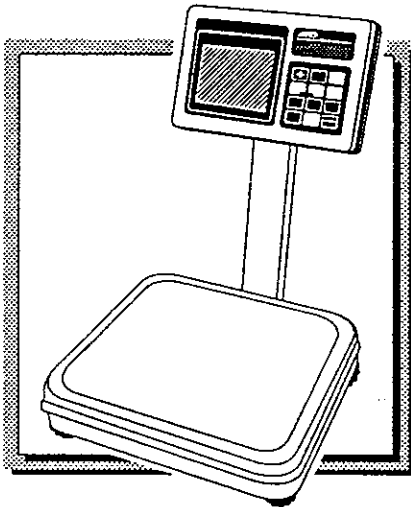

## FS/FS-KL Series • Section B

# Introduction



## Welcome!

Thank You for Your **AND** Purchase!

*This is an INSTRUCTION MANUAL for the FS/FS-KL check-weighing scale. The FS/FS-KL Scale is the product of years of design, development, and in-field testing. Every care has been taken during the manufacturing process of this scale; and each scale is subjected to several levels of quality control before it leaves the factory to ensure that it will perform accurately and reliably for many years.*



This section introduces you to some of the major features of your FS/FS-KL. Please take a moment to familiarize yourself with these items as they could be helpful for proper operation.



## Features

- Weighing units are **kg** kilogram. (**lb** pound; **oz** ounces; and **lb-oz** pounds and ounces on the U.S.A. version).
- Waterproof to IP-65 specifications.
- Constructed from stainless steel for harsh working environment .
- Large liquid crystal display with back lighting on the FS/FS-KL-B models.
- The display area has an analog sweep display of 31 segments.
- Scale may be powered from batteries or from an A.C. adaptor.
- Battery life of greater than 200 hours from manganese batteries. (FS/FS-KL-A)
- Built in comparator with front panel display of results.
- Optional serial data and comparator relay interface.
- Three capacities available to cover all bench scale applications.
- Large pan area for easy weighing.
- Three modes of operation, SIMPLE / LIMIT / TARGET.
- Self-contained portable design for easy moving.





**Specifications**

Description	FS-6KA	FS-15KA	FS-30KA	FS-6KB	FS-15KB	FS-30KB
Maximum Capacity	6 kg 15 lb 240 oz	15 kg 35 lb 560 oz	30 kg 70 lb 1120 oz	6 kg 15 lb 240 oz	15 kg 35 lb 560 oz	30 kg 70 lb 1120 oz
Min. Division kg	1g / 3 kg 2g / 6 kg	2g / 6 kg 5g / 15 kg	5g / 15 kg 10g / 30 kg	1g / 3 kg 2g / 6 kg	2g / 6 kg 5g / 15 kg	5g / 15 kg 10g / 30 kg
lb	0.002 lb / 6 lb 0.005 lb / 15 lb	0.005 lb / 15 lb 0.01 lb / 35 lb	0.01 lb / 35 lb 0.02 lb / 70 lb	0.002 lb / 6 lb 0.005 lb / 15 lb	0.005 lb / 15 lb 0.01 lb / 35 lb	0.01 lb / 35 lb 0.02 lb / 70 lb
oz	0.05 oz / 120 oz 0.1 oz / 240 oz	0.1 oz / 240 oz 0.1 oz / 560 oz	0.2 oz / 560 oz 0.5 oz / 1120 oz	0.05 oz / 120 oz 0.1 oz / 240 oz	0.1 oz / 240 oz 0.1 oz / 560 oz	0.2 oz / 560 oz 0.5 oz / 1120 oz
lb-oz	0.1 oz / 15 lb	0.2 oz / 35 lb	0.5 oz / 70 lb	0.1 oz / 15 lb	0.2 oz / 35 lb	0.5 oz / 70 lb
Display Type	Liquid Crystal Display. Digital section - 7 segment x 5 digits 16mm height. Analog sweep display section with 31 segments. With backlighting (FS-B)					
Sensitivity Drift	20 p.p.m. / °C					
Operating Temperature	-5 °C ~ 40 °C 23 °F ~ 104 °F					
Power Supply <i>Batteries</i>	6 x C cell dry batteries. High Capacity Manganese Alkaline 200 Hours (FS-A) 15 Hours (FS-B) 400 Hours (FS-A) 30 Hours (FS-B)					
<i>Mains</i> (+10%/-15%)	A.C. Adaptor (8 volt 250mA D.C. output) TB 162 A.C.100 V 'A' type plug. TB 163 A.C.120 V 'A' type plug. TB 164 A.C.220 V 'C' type plug. TB 172 A.C.240 V 'S' type plug.(Aust.) TB 173 A.C.240 V 'BF' type plug.					
Dimensions <i>Overall</i>	310 x 450 x 444 mm			12.2 x 17.7 x 17.5 inches.		
<i>Pan Size</i>	310 x 310 mm			12.2 x 12.2 inches.		
Packed Weight	11kg			24.2lb		

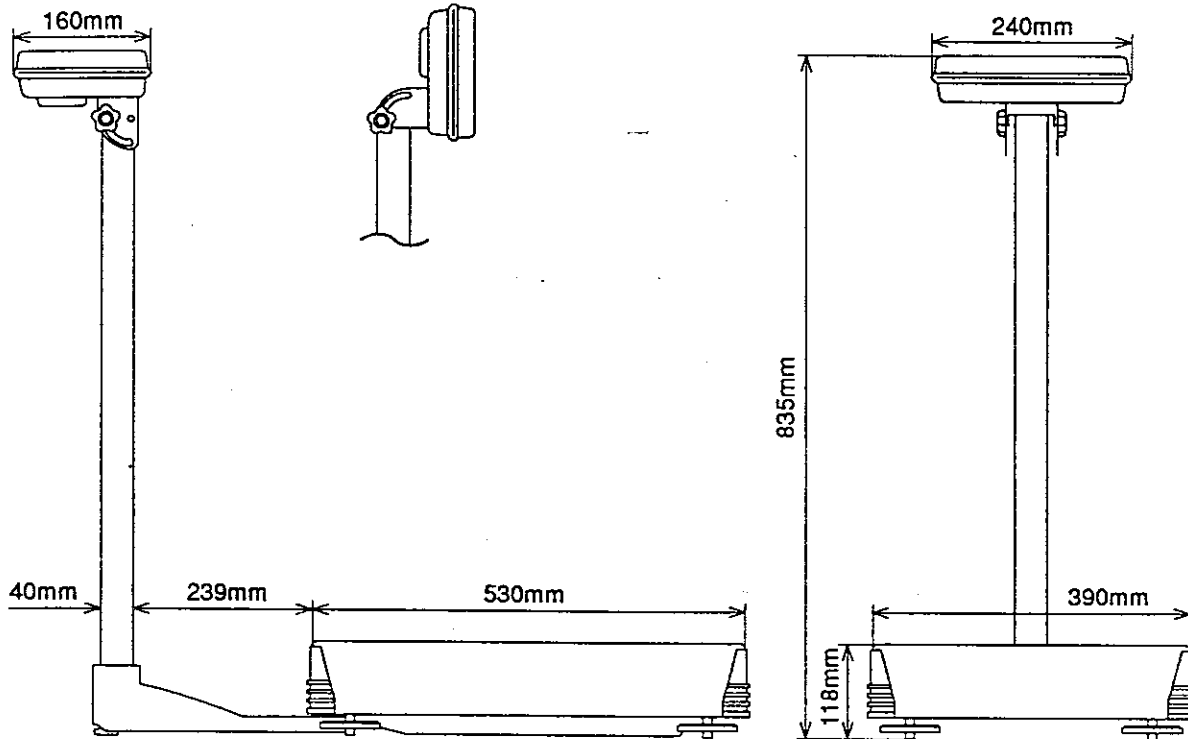

# Dimensional outline drawing

## FS-60KL/150KL



## FS-30KL

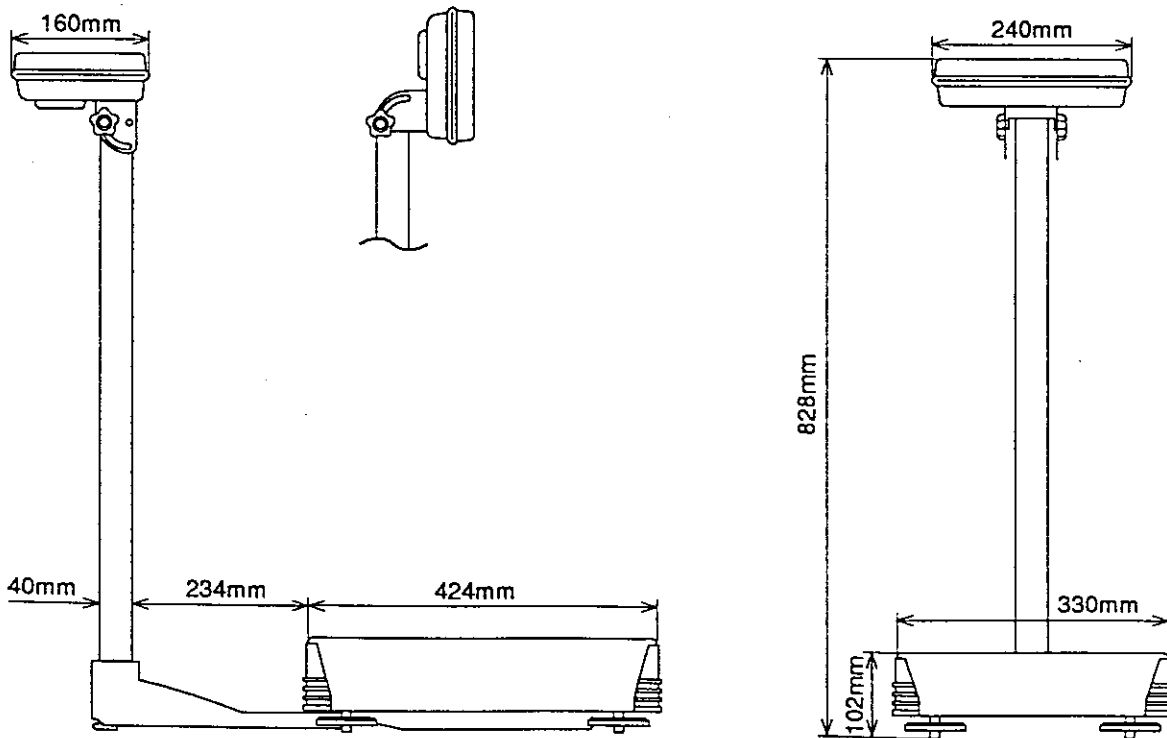



## Description of Front Panel

FS-01

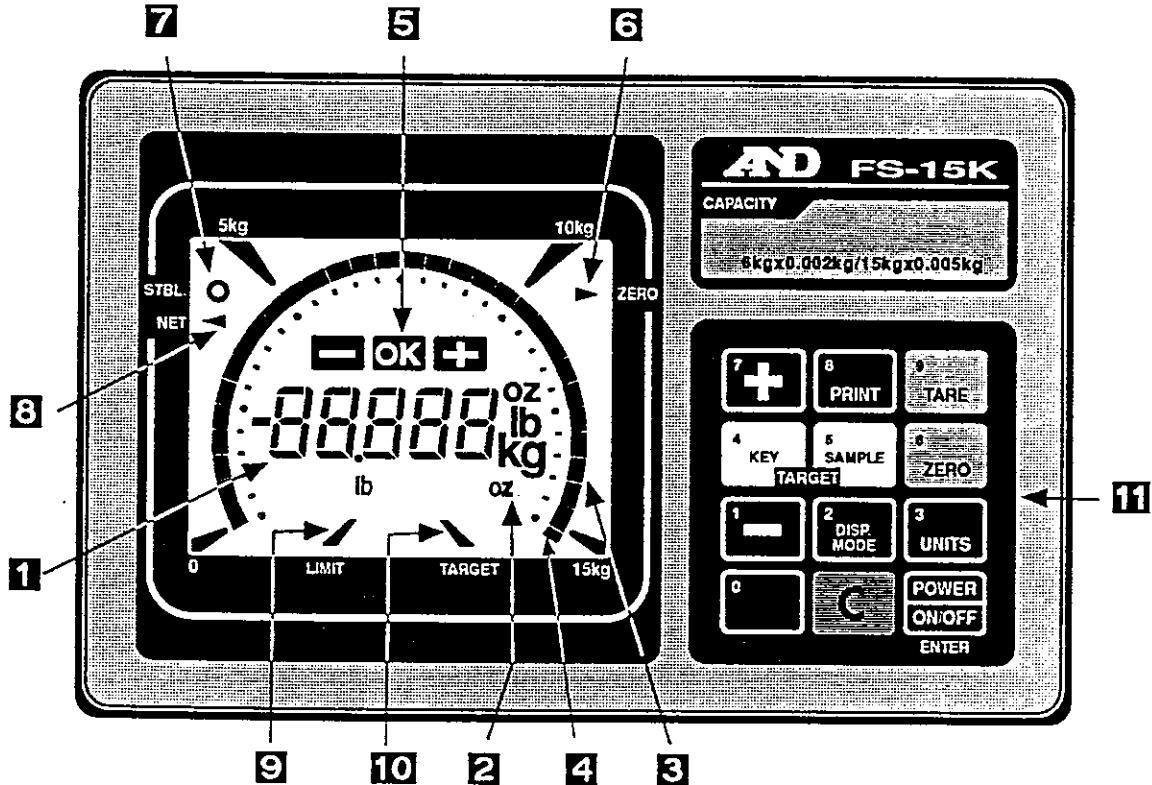

### 1 WEIGHT DATA DISPLAY.

A 5 digit display that shows the weight on the platform.  
If there is a weighing error then a message will appear in this area.

### 2 WEIGHING UNIT INDICATOR.

This display area shows the weighing unit in use.

### 3 ANALOG WEIGHT DISPLAY.

This scale has a 30 element analog sweep display representing zero to full scale when the **SIMPLE** weighing mode is selected. In **LIMIT** and **TARGET** modes this display shows comparison limits and results.

### 4 OVER RANGE INDICATOR.

Segment number 31 of the analog sweep display comes ON when the weight is outside the full scale range of the sweep display.

## **5** COMPARISON INDICATORS.

The indicators: -, 0 and + show the results of the weight comparison.

## **6** ZERO ANNUNCIATOR.

This annunciator will come ON when the scale is showing the center of ZERO.

## **7** STBL ANNUNCIATOR.

This annunciator will come ON when the weight reading is STABLE.

## **8** NET ANNUNCIATOR.

This annunciator will come ON when the scale is displaying the NET weight on the platform.

## **9** LIMIT ANNUNCIATOR.

This annunciator will come ON when the scale is in the LIMIT mode of operation.

## **10** TARGET ANNUNCIATOR.

This annunciator will come ON when the scale is in the TARGET mode of operation.

## **11** KEYPAD.

A 12 key pad provides control and number keys.

## Description of Key Operations

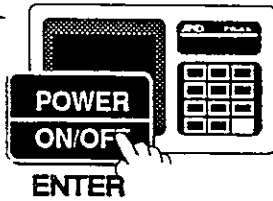

### *The POWER ON/OFF Key*

---

In any of the weighing modes the **POWER ON/OFF** key switches the scale between the ON and OFF states.

In the data entry sequence this key is used to ENTER the numeric data into the scale memory.

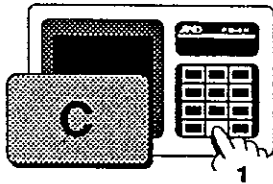

### *The C Key*

---

The **C** key is used to clear an incorrect data entry from the numeric keys.

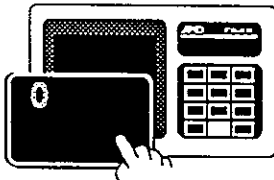

### *The '0' Key*

---

The **0** key is used to display the number 0 during a data entry sequence.

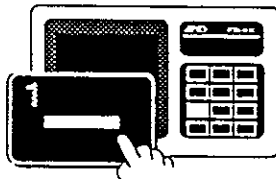

### *The -/'1' Key*

---

Pressing the **-/'1'** key allows you to then enter the comparator **LO LIMIT** using the numeric keypad.

In the data entry sequence this key displays the number 1.

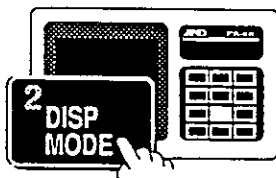

### *The DISP MODE/'2' Key*

---

When the **DISP MODE** key is pressed the scale display mode steps through the 3 available modes of **SIMPLE**, **LIMIT** and **TARGET**.

In the data entry sequence this key displays the number 2.

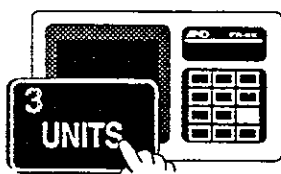

## *The UNITS/'3' Key*

---

The **UNITS** key is used to select the desired weighing unit . (*USA ONLY*)

In the data entry sequence this key displays the number 3.

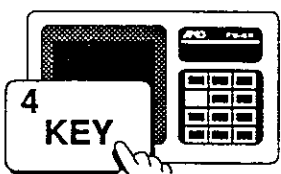

## *The KEY/'4' Key*

---

The **KEY** key allows you to enter sample weight using the keyboard.

In the data entry sequence this key displays the number 4.

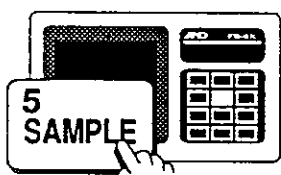

## *The SAMPLE/'5' Key*

---

The **SAMPLE** key will register the sample weight as the target.

In the data entry sequence this key displays the number 5.

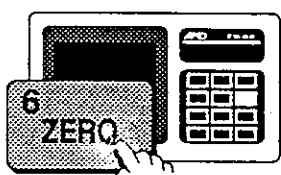

## *The ZERO/'6' Key*

---

The **ZERO** key re-zeros an empty scale when the weight is stable (STBL annunciator ON). The ZERO annunciator will come ON.

In the data entry sequence this key displays the number 6.

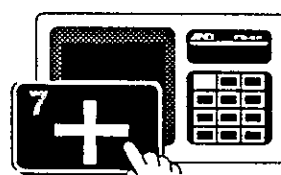

## *The +/'7' Key*

---

Pressing the **+** key allows you to then enter the comparator **HI LIMIT** using the numeric keypad.

In the data entry sequence this key displays the number 7.

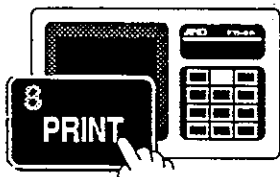

## *The PRINT/'8' Key*

---

The **PRINT** key is used when the serial data option OP-03 is installed and sends one data string.

In the data entry sequence this key displays the number 8.

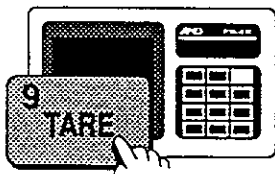

## *The TARE /'9' Key*

---

The **TARE** key switches the scale to net mode and ZERO's the weight display. The NET annunciator will come ON.

In the data entry sequence this key displays the number 9.





## Changing the Weighing Mode



The FS/FS-KL scale has three weighing modes. The current weighing mode is selected by pressing the **DISP MODE** key. Two annunciators, **LIMIT** and **TARGET** show which mode is active.

If neither annunciator is shown then the scale is in the **SIMPLE WEIGHING** mode.



### Simple Weighing Mode (see Section D )

In the Simple Weighing mode the scale can be used to show the weight on the pan in both analog and digital formats. The comparator will indicate the judgment between the weight on the pan and the stored targets.



### Limit Check Weighing Mode (see Section E )

The Limit Check weighing mode provides for easy check weighing of products. The lower and upper limits are easily set into the scale via the keyboard. The *ideal* or *target* weight may be entered via the keyboard or a sample may be weighed. The TARE facility may be used if the item(s) to be check weighed are in a container.



### Target Weighing Mode (see Section F )

Target weighing mode provides a simple way of filling a container to a target weight. The target weight is shown on the analog part of the display as a flashing segment.

The -, O and + annunciators keep the operator informed of the progress of the filling operation.

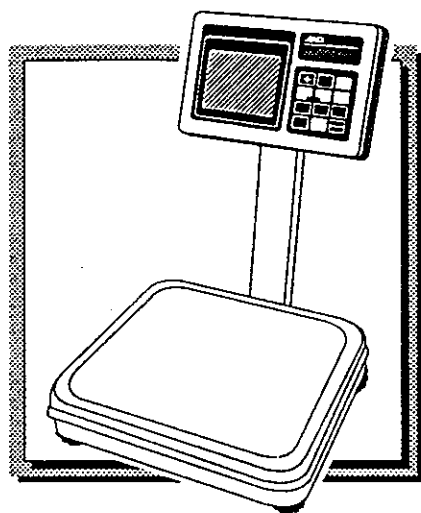

## FS/FS-KL Series • Section C

# Calibration



# About Calibration



The initial calibration of the FS/FS-KL scale is carried out at your dealer's premises prior to delivery of the scale. Additional calibration may be required if the scale is moved often or is moved over a substantial distance.



## Calibration Procedure

1

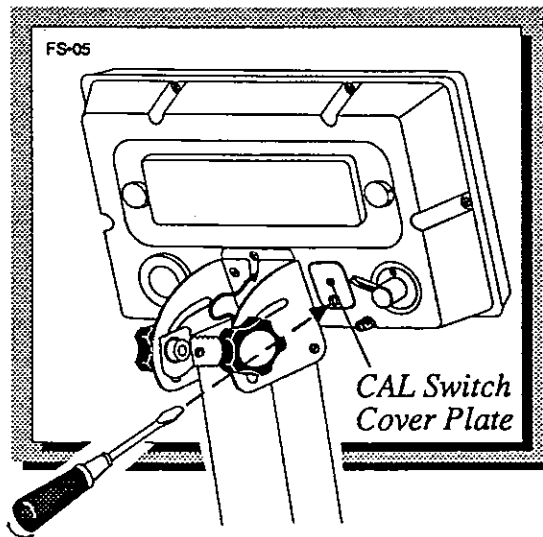

- ▶ Locate and remove the CAL switch cover.

⚠ *In certain countries this cover plate may be wire sealed. Under no circumstances break this seal. Call for a qualified scale technician.*

2

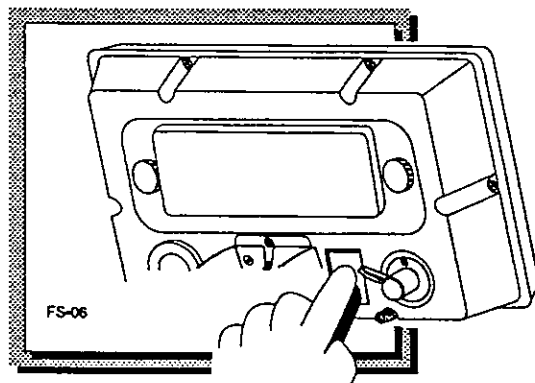

- ▶ Press the CAL switch.

- The display will show

[ kg

## Gravity Compensation



If you do not wish to adjust the Gravity Compensation factor then do not press the **PRINT** key and by-pass this section. Refer to the Appendix (Section AP) for more information on Gravity Compensation.

1



▶ Press the **PRINT** key.

○ The display will show **9.800 kg** *the factory or last setting.*

2

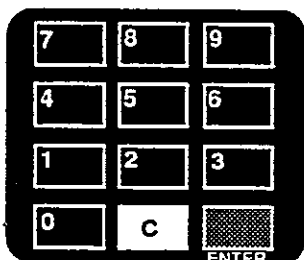

▶ Use the number keys to set the required gravity compensation factor, for example **9 7 9 8**.

○ The display shows **9.798 kg**

3



▶ Press the **POWER ON/OFF** key.

○ The display will show **[ ] kg**

# Zero and Span Calibration



The FS/FS-KL scale can be calibrated in either kilograms or in pounds.

*In this example an FS-6K (Metric) scale is assumed.*

## Zero Calibration

**1**



▶ Press the **UNITS** key to select the calibration weight unit.

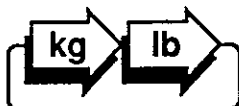

○ The display will show



**2**



▶ Press the **TARE** key.

○ The display will show



**3**



▶ Make sure that no weight is on the pan and press the **POWER ON/OFF** key.

○ The display will show for a few seconds.

○ The display will then show

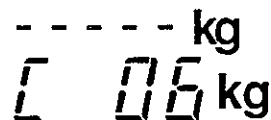

If you only wish to carry out a zero calibration, then you can exit now by pressing the **C** key.



# Span Calibration

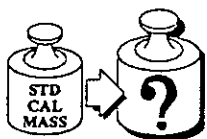

The FS/FS-KL scale can be calibrated with a mass less than the maximum capacity of the scale.

For maximum accuracy it is recommended that the maximum mass is used for calibration.

RECOMMENDED CALIBRATION MASS WEIGHTS			
	FS-6K	6kg	15lb
	FS-15K	15kg	30lb
	FS-30K	30kg	70lb

RECOMMENDED CALIBRATION MASS WEIGHTS			
	FS-30KL	30kg	70lb
	FS-60KL	60kg	150lb
	FS-150KL	150kg	350lb

4

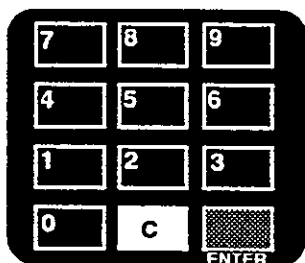

▶ Use the number keys to set the calibration mass to be used, for example -:

5 for a 5.0 kg mass.

⚠ Press  1  5 for a 15.0 kg or  3  0 for a 30.0 kg mass.

○ The display will show

5

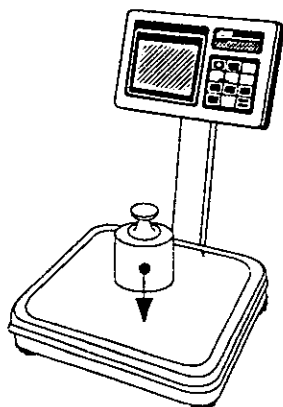

▶ Place the Calibration Mass on the Platform.

**6**



▶ Press the **POWER ON/OFF** key.

○ The display will show **-----kg** for a few seconds.

○ Then it will show **[ End kg**



If there was an error during the calibration routine then by pressing the **[C]** key the sequence can be repeated.

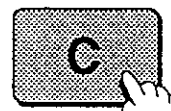

**7**



▶ Make sure that there were no calibration errors and press the **POWER ON/OFF** key.

○ Calibration is finished and the scale returns to the weighing mode.

## Calibration Messages

**[**

○ Waiting for a command from the operator.

**[ 0**

○ Waiting for ZERO calibration.

**[ 88**

○ Waiting for SPAN calibration.  
(**88** is span mass)

**[ Err**

- If this occurs at Step 3 then ensure pan is empty and repeat the calibration.
- If this occurs at Step 6 then check that the calibration mass is the same as the value entered at Step 4 and repeat the calibration.

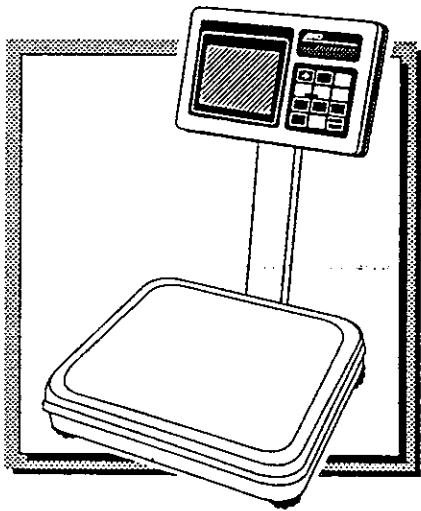

## FS/FS-KL Series • Section D

# Simple Weighing Mode



# Simple Weighing

**1**



- Press the **POWER ON/OFF** key to switch ON the scale.
- The scale will perform a display check and all digits and annunciators will come on for a short time. The scale will then perform a 'count up' test on the weight display.



The 'count up' test may be by-passed by pressing the **C** key and then the **ZERO** key.



- The scale will then display dashes while waiting to get the ZERO point.
- The scale then displays zero.

- - - - - k g  
0.0000 kg

**2**



-  *This step refers to U.S.A. version only.*
- Press the **UNITS** key to select the weighing unit if necessary.
- Each depression of the key will step the weighing unit through the available list as set by the factory.

**3**

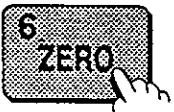

- Press the **ZERO** key to zero the weight display if necessary.

0.0000 kg

4

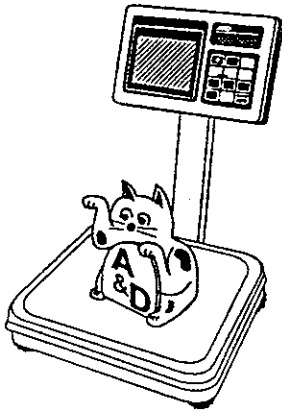

- ▶ Place the item to be weighed onto the pan.
- The display will show the weight of the item.
- When the weight is stable, the STBL annunciator will come on.

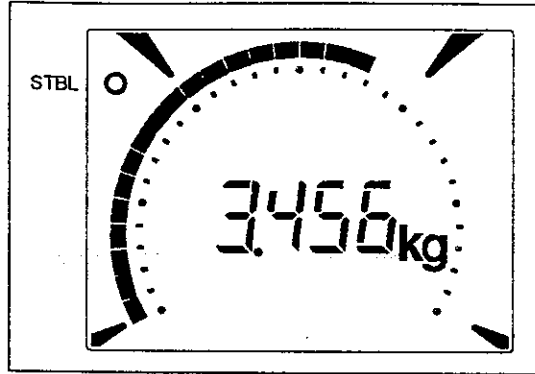

# Simple Weighing with Tare

1



▶ Press the **ZERO** key to zero the weight display if necessary.

0.0000 kg

2

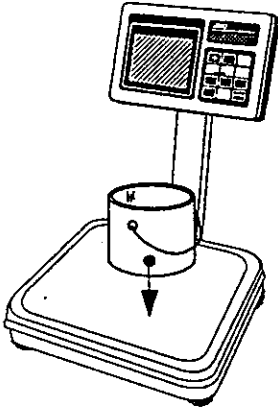

▶ Place the empty container {the item to be TARED } onto the pan.

- The display will show the weight of the item.
- When the weight is stable, the STBL annunciator will come on.

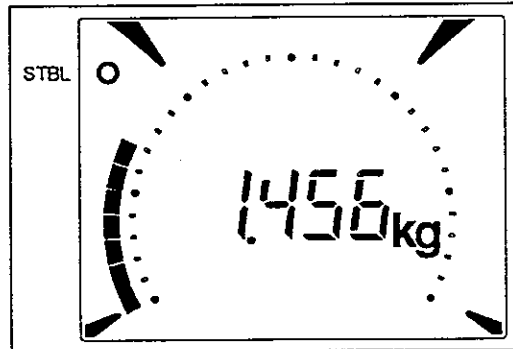

3



▶ Press the **TARE** key to zero the weight display and show the NET annunciator.

0.0000 kg

4

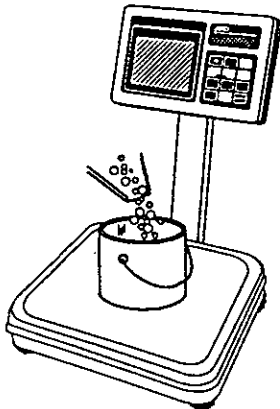

▶ Place the item(s) to be weighed into the container.

- The display will show the NET weight of the item(s).

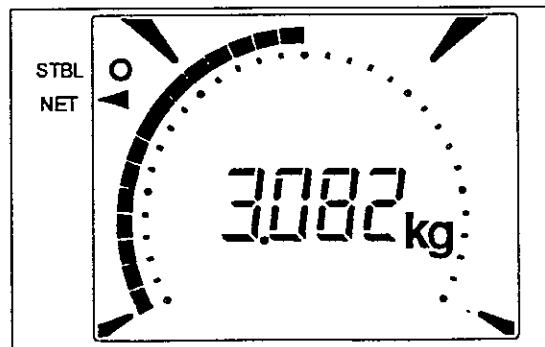

## To Clear a Stored Tare (Method #1)

1

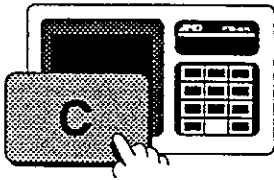

- ▶ Press and hold the **C** key.

2

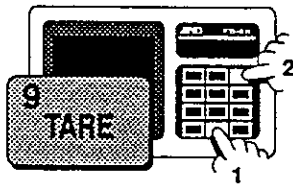

- ▶ While holding the **C** key pressed, press the **TARE** key.
- The NET ◀ annunciator goes off.

## To Clear a Stored Tare (Method #2)

1

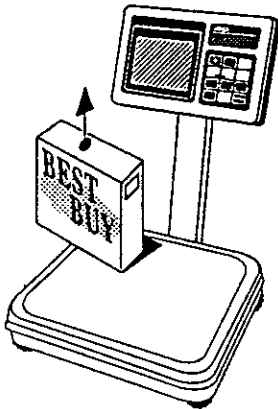

- ▶ Remove all items from the pan.

2



- ▶ Press the **ZERO** key to clear any zero offset.

3



- ▶ Press the **TARE** key.
- The NET ◀ annunciator goes off.

# Error Messages



While the scale is in use, there are certain error messages that could appear in the Digital Weight Display area. These are detailed below along with the necessary action to take.

### Power ON Error:

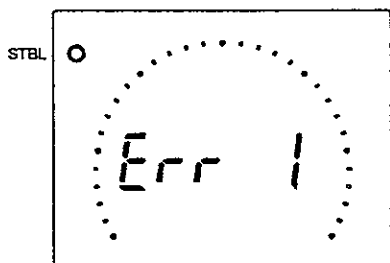

Err 1 is displayed if there was a weight on the pan when the scale was switched ON.

- Remove the weight from the pan.

### Hardware Error :

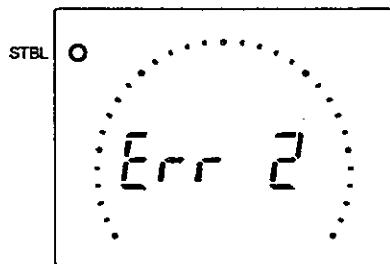

Err 2 is displayed if there has been a failure in the non volatile RAM.

- Call your service technician.

### Battery Voltage:

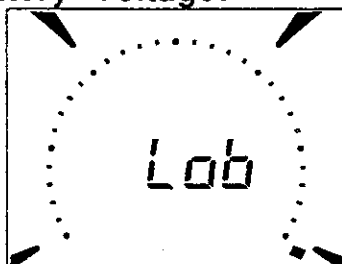

Lo b is displayed if the battery life has expired.

- Replace the batteries. See page A-7.

### Overloaded Pan:

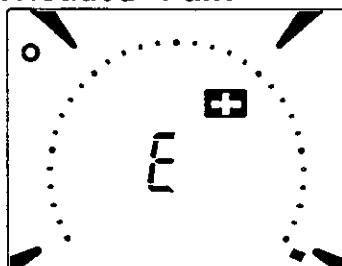

+ E is displayed when the scale pan is overloaded.

- Remove the excessive weight from the pan.

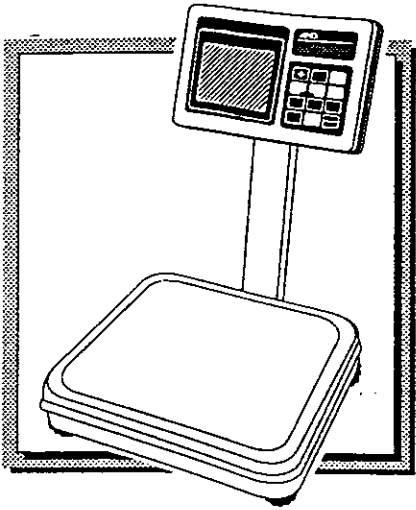

**FS/FS-KL Series • Section E**

Limit Check  
Weighing Mode



# Limit Check Weighing Mode

- The LIMIT CHECK WEIGHING MODE provides for easy check weighing of products. The lower and upper limits are easily set into the scale via the keyboard. The *ideal* or *TARGET WEIGHT* may be entered via the keyboard or a sample may be weighed.

See COMPARATOR (section G) for details of TARGET WEIGHT settings.

The TARE facility may be used if the item(s) to be check weighed are in a container.

*In the following example the TARGET WEIGHT is set to 3.000 kg, the LO LIMIT is set to 0.026 kg and the HI LIMIT is set to 0.026 kg.*

**1**



- ▶ Press the **DISP MODE** key to select the **LIMIT CHECK WEIGHING MODE**.

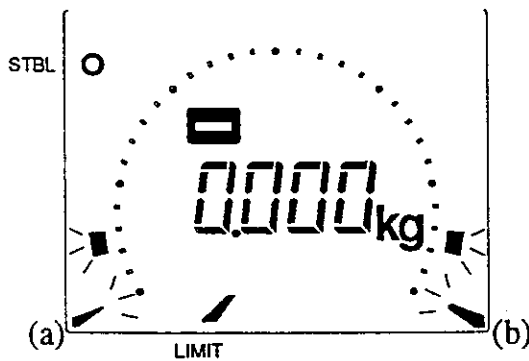

- The LIMIT annunciator will come on and the analog part of the display will flash at the previously set - and + limits.
- If either limit is within the range of the analog sweep display then the corresponding segment will flash.
- If either limit is outside the range of the analog sweep display then the corresponding limit annunciator (a) or (b) will flash to show an off range limit.

**2**



- ▶ Press the **ZERO** key to zero the weight display if necessary.

0.0000 kg

**3**

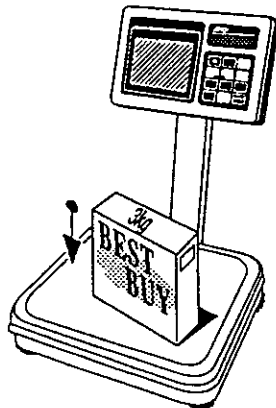

- ▶ Place the item to be check weighed onto the pan.
- The result of the weighing will be shown on the display.

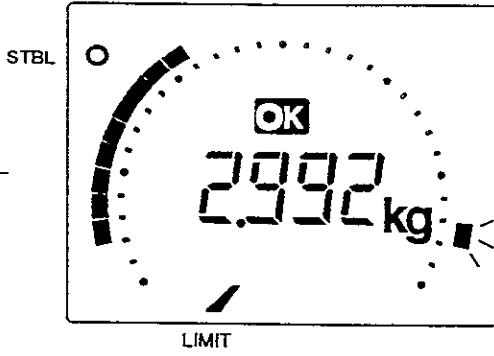

○ If the item is **within** the set limits.

⚠ In our example, greater than or equal to :  
TARGET WEIGHT - LO LIMIT (2.974 kg)  
and less than or equal to :  
TARGET WEIGHT + HI LIMIT (3.026 kg)

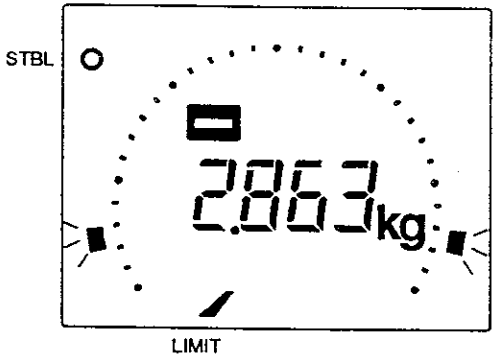

○ If the item is **below** the set limits.

⚠ In our example, with weight less than :  
TARGET WEIGHT - LO LIMIT (2.974kg)

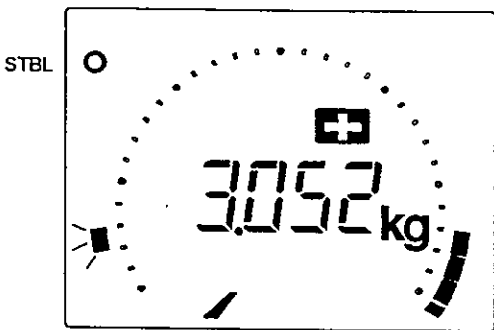

○ If the item is **above** the set limits.

⚠ In our example, with weight greater than :  
TARGET WEIGHT + HI LIMIT (3.026 kg)



The sensitivity of the analog part of the display is set by Function F3. See FUNCTION SETTINGS (page H•5.)

⚠ In our example, F3 is set to 2  
so each sweep segment = 2 x 0.001 kg or 2g.



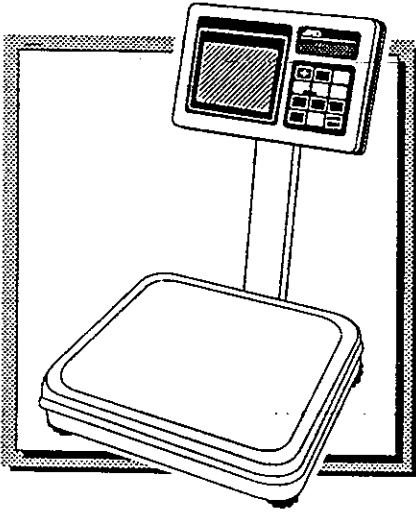

**FS/FS-KL Series • Section F**

**Target Weighing  
Mode**

# Target Weighing Mode

TARGET WEIGHING MODE provides a simple way of filling a container to a target weight. The lower and upper limits are easily set into the scale via the keyboard. The *ideal* or *TARGET WEIGHT* may be entered via the keyboard or a sample may be weighed.

The analog sweep display may be configured by function  $F[\ ]$  to one of two representations.

In the *normal mode* ( $F[\ ]$ ) the full sweep represents the full scale capacity whilst in the *percentage mode* ( $F[\ ]$ ) the first 20 segments represent 100% of the target weight.

## Normal Mode - $F[\ ]$

The target weight is shown on the analog part of the display as a flashing segment. The -, 0 and + annunciators keep the operator informed of progress of the filling operation.

See COMPARATOR (section G) for details of TARGET WEIGHT settings.

*In the following example the TARGET WEIGHT is set to 1.500 kg, the LO LIMIT is set to 0.100 kg and the HI LIMIT is set to 0.120 kg.*

1



▶ Press the **DISP MODE** key to select the TARGET WEIGHING MODE.

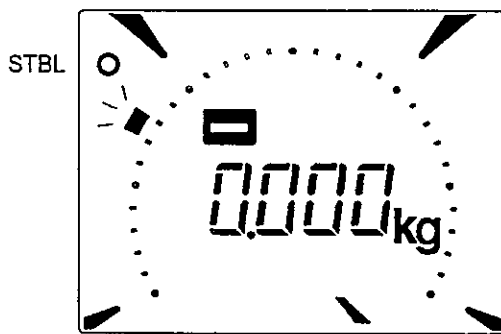

○ The TARGET annunciator will come on and the analog part of the display will flash at the previously set TARGET weight.

2



▶ Press the **ZERO** key to zero the weight display if necessary.

0.000 kg

3

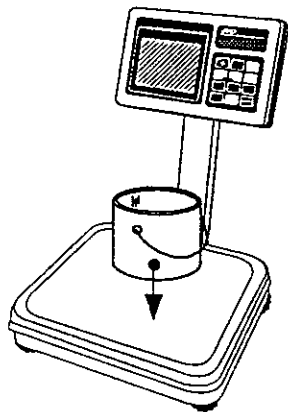

- ▶ Place the empty container onto the pan.
- The weight of the container will be shown on the display.

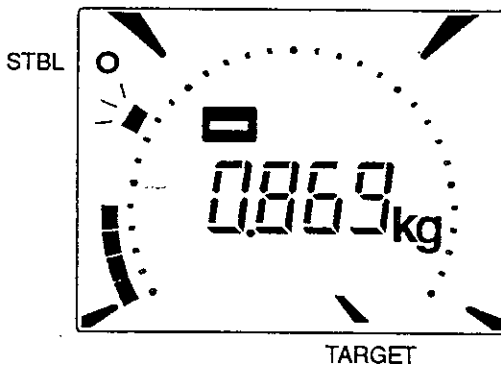

4

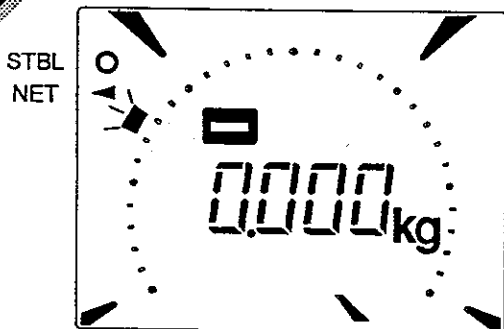

- ▶ Press the **TARE** key to zero the weight display and light the NET annunciator.



5

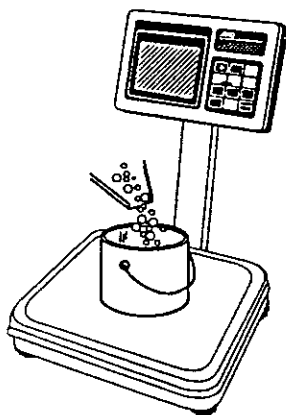

- ▶ Add product to the container watching the display.
- As product is added, the analog part of the display can be seen to approach the flashing target segment.

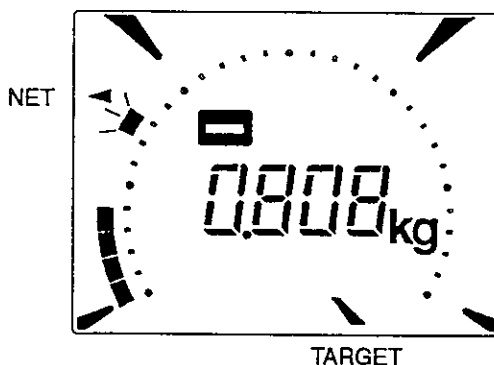

6

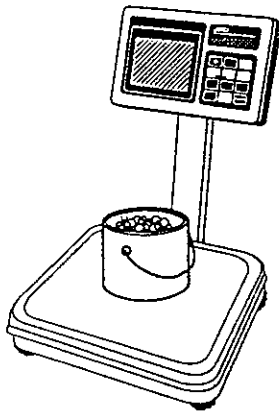

▣ Stop adding product when the - annunciator goes out and the ok annunciator comes on.

⚠ The actual changeover point is at TARGET WEIGHT - LO LIMIT  
ie. 1.500 kg - 0.100kg = 1.400 kg

○ The weight of the product will be accurately shown on the digital part of the display.

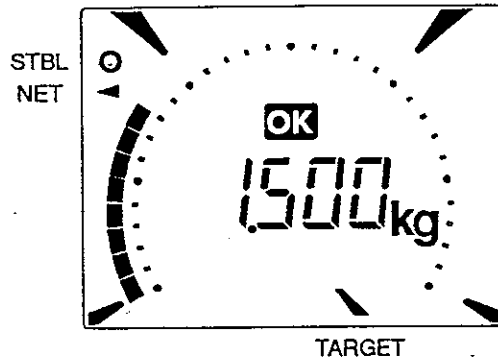

## Percentage Mode - FL 1

The target weight is shown on the analog part of the display as a flashing segment number 20. The -, OK and + annunciators keep the operator informed of progress of the filling operation.

See COMPARATOR (section G) for details of TARGET WEIGHT settings.

*In the following example the TARGET WEIGHT is set to 1.500 kg, the LO LIMIT is set to 0.100 kg and the HI LIMIT is set to 0.120 kg.*

1



▣ Press the **DISP MODE** key to select the TARGET WEIGHING MODE.

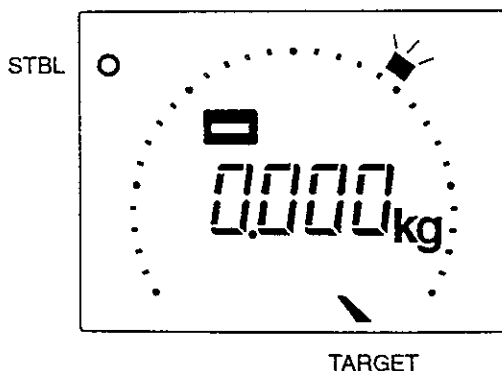

○ The TARGET annunciator will come on and the analog part of the display will flash at the twentieth segment - representing 100% of the previously set target. (Each segment represents 5% of the target.)

⚠ If the target has been set to less than 20 scale graduations then each segment will represent one graduation.



▶ Press the **ZERO** key to zero the weight display if necessary.

0.000 kg

3

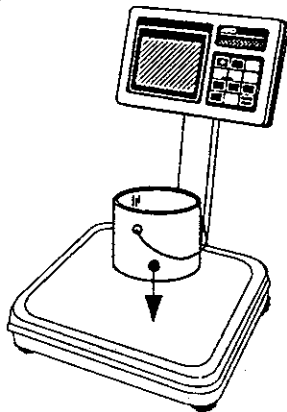

▶ Place the empty container onto the pan.

○ The weight of the container will be shown on the display.

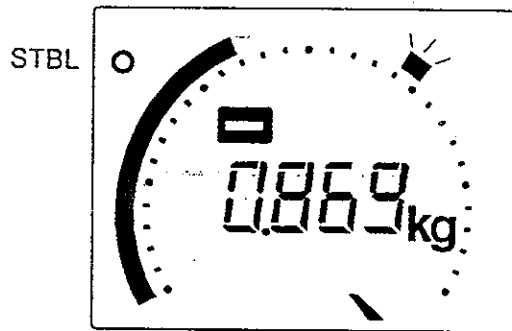

TARGET

4

STBL  
NET

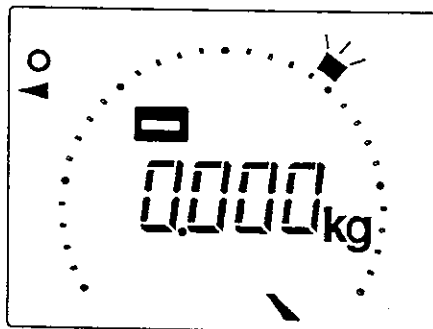

TARGET

▶ Press the **TARE** key to zero the weight display and light the NET annunciator.

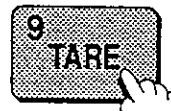

5

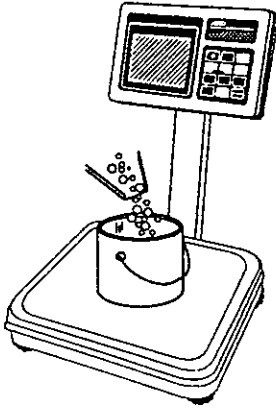

- ▶ Add product to the container watching the display.
- As product is added, the analog part of the display can be seen to approach the flashing 100% target segment.

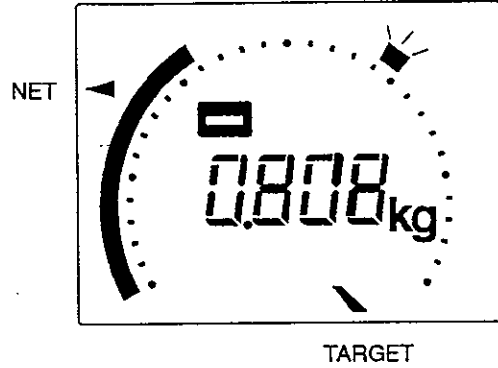

6

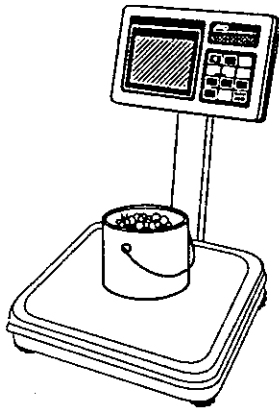

- ▶ Stop adding product when the - annunciator goes out and the ok annunciator comes on.
- ⚠ *The actual changeover point is at TARGET WEIGHT - LO LIMIT ie. 1.500 kg - 0.100kg = 1.400 kg*
- The weight of the product will be accurately shown on the digital part of the display.

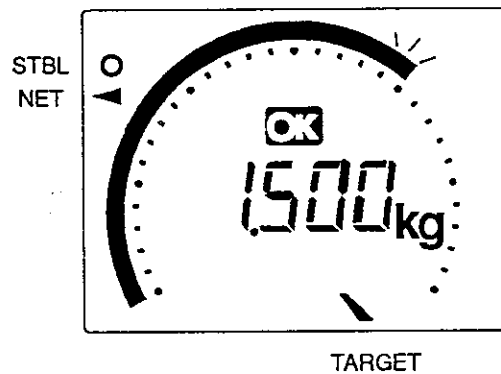

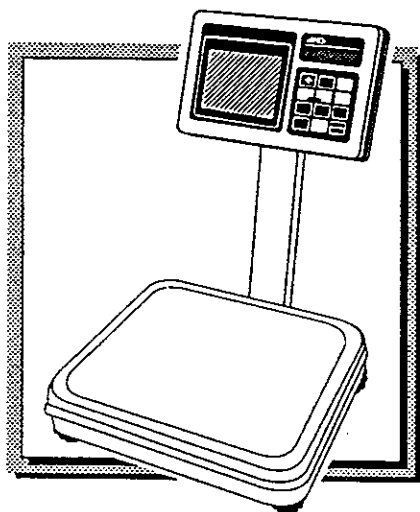

**FS/FS-KL Series • Section G**

Comparator

# Using the Comparator

The comparator can be used in any of the three weighing modes and is turned on or off by using Function F1 (page H•4).



The comparator compares the weight on the display with the preset target and upper and lower limits. This result is shown as the symbols +, - and ok on the display.

The comparator output can be obtained on relays by fitting option OP-03 (see section I).

# Setting Target Weight by Key



**TARGET SETTING** can only be done from one of the three weighing modes. **Make sure that the scale is in a weighing mode before proceeding.**

**1**



- Press the **KEY** key.
- The ok annunciator will flash and the last **TARGET WEIGHT** entered will be displayed.

**2**

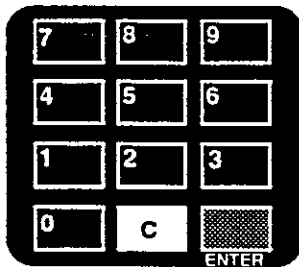

- Enter the **TARGET WEIGHT** on the numeric keypad.
- As each number key is pressed that number moves in on the right side of the **TARGET WEIGHT DISPLAY**.



If an error is made then press the **C** key and the **OLD TARGET WEIGHT** is re-displayed. Continue data entry as at step 2.

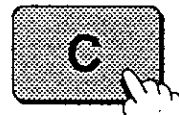

**3**



- Press the **POWER ON/OFF** key to set the **TARGET WEIGHT** in memory.



## Setting the HI Limit



The HI LIMIT is the amount to be added to the TARGET WEIGHT to get the highest acceptable or UPPER TARGET WEIGHT .  
 $TARGET\ WEIGHT + HI\ LIMIT = UPPER\ TARGET\ WEIGHT$

For example, to set the highest acceptable limit to 5.1kg on a 5kg target , set the HI LIMIT to 0.1kg.



LIMIT SETTING can only be done from one of the three weighing modes. **Make sure that the scale is in a weighing mode before proceeding.**

1



- ▶ Press the  key.
- The ok annunciator will flash and the last HI LIMIT entered will be displayed.

2

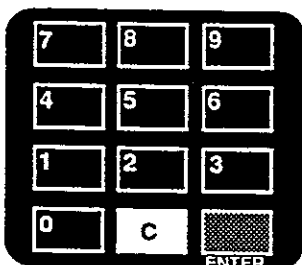

- ▶ Enter the HI LIMIT on the numeric keypad.
- As each number key is pressed that number moves in on the right side of the LIMIT WEIGHT DISPLAY.



If an error is made then press the  key and the OLD HIGH LIMIT is re-displayed. Continue data entry .

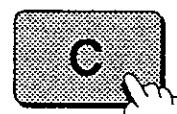

3



- ▶ Press the  key to set the HI LIMIT in memory.

## Setting the LO Limit



The LO LIMIT is the amount to be taken off the TARGET WEIGHT to get the lowest acceptable or LOWER TARGET WEIGHT .  
 $TARGET\ WEIGHT - LO\ LIMIT = LOWER\ TARGET\ WEIGHT$

For example, to set the lowest acceptable limit to 4.8kg on a 5kg target set the LO LIMIT to 0.2kg.



LIMIT SETTING can only be done from one of the three weighing modes. **Make sure that the scale is in a weighing mode before proceeding.**

1



- ▶ Press the  key.
- The ok annunciator will flash and the last LO LIMIT entered will be displayed.

2

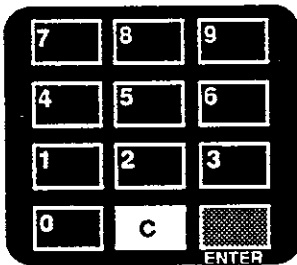

- ▶ Enter the LO LIMIT on the numeric keypad.
- As each number key is pressed that number moves in on the right side of the LIMIT WEIGHT DISPLAY.



If an error is made then press the  key and the OLD LOW LIMIT is re-displayed. Continue data entry.



3



- ▶ Press the  key to set the LO LIMIT in memory.

# Setting Target Weight by Sample

1

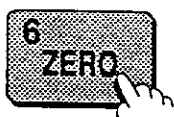

▶ Press the **ZERO** key to zero the weight display if necessary.

0.0000 kg

2

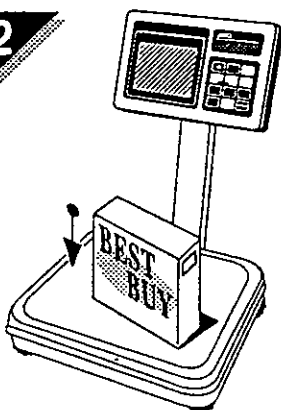

▶ Place the sample onto the weighing pan.

○ The display shows the sample item's weight.

3.0002 kg

3



▶ Press the **SAMPLE** key. STBL

○ The ok annunciator flashes and the **SAMPLE WEIGHT** is displayed.

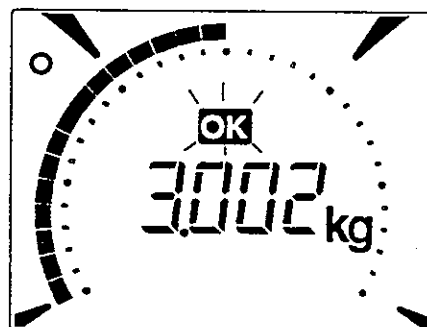

4



▶ Press the **POWER ON/OFF** key to set the **SAMPLE WEIGHT** in memory.

○ The display will show dashes for a few seconds before storing the **SAMPLE WEIGHT**.

----- kg

## The Comparator Memory

The comparator has an 8 slot memory. Limits may be recalled from memory using the keyboard.

## Storing a Set of Limits in Memory

**1**  Set the Target weight by keyboard or by sample. See G-2 and G-5 above for details.

---

**2**  Set the + and - limits via the keyboard.

---

**3**  Press and hold the **KEY** key.



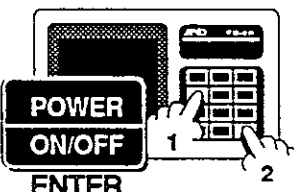

---

**4**  While holding the **KEY** key down, press the **POWER ON/OFF** key.



The display will show **5d 0**

---

**5**  Press the memory number, for example 6.

The display will show **5d 6**

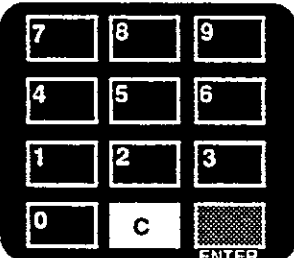



---

**6**  Press the **POWER ON/OFF** key to store the data into the memory.

The scale will return to the weighing mode.

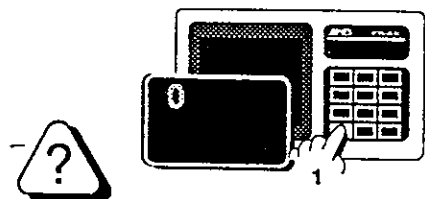

---



⚠ If you do not wish to store the limits to memory for example, because an error was made in the data, then press the **0** key and hold it down.

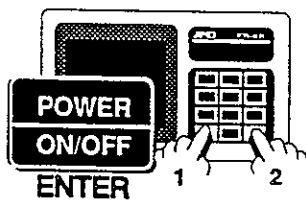

⚠ Then press the **POWER ON/OFF** key.

## Recalling a Limit from Memory

1

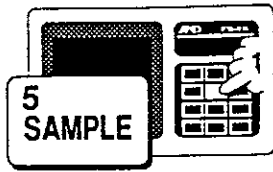

▶ Press and hold the **SAMPLE** key.

2

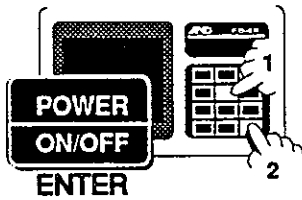

▶ Whilst holding the **SAMPLE** key pressed, press the **POWER ON/OFF** key.

○ The display will show

*Ld 0*

3

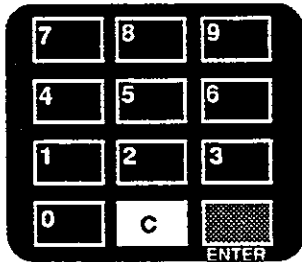

▶ Press the memory number, for example 3.

○ The display will show

*Ld 3*

4



▶ Press the **POWER ON/OFF** key to place the stored data into the comparator.

○ The scale will return to the weighing mode.

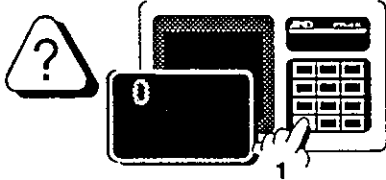

⚠ If you have made an error for example, by entering the wrong number, then press the **0** key and hold it down.

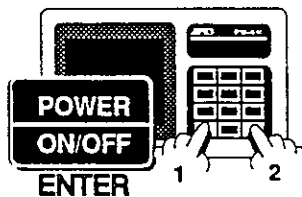

⚠ Then press the **POWER ON/OFF** key.

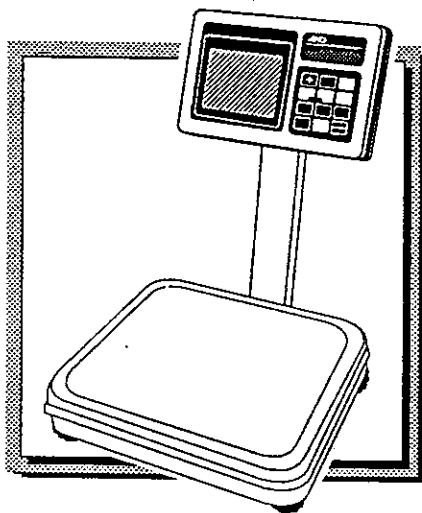

## FS/FS-KL Series • Section H

# Function Settings



## Internal F-Functions



Your FS/FS-KL scale has a number of internal software parameters that enable you to select the best weighing features for your needs. These settings control how you want the scale to respond to its environment, various commands, operations and options. An overall F-Function list is shown below.

All of the F-Functions have initial settings from the factory, or possibly from your dealer. You may change these settings easily as you need them, or as conditions vary.

F-Functions can be set using the method as explained in the section CHANGING F-FUNCTIONS page H•3. The individual settings for each group are detailed in the following section THE F-FUNCTIONS, pages H•4 to H•9.

<i>F 1</i>	Comparator condition settings.
<i>F 2</i>	Liquid crystal display selection.
<i>F 3</i>	LIMIT weighing analog display magnification.
<i>F 4</i>	<b>UNIT Selection - U.S.A. VERSION ONLY.</b>
<i>F 5</i>	Automatic power down setting.
<i>F 6</i>	Front Panel key lockout.
<i>F 7</i>	Scale response speed.
<i>F 8</i>	Power ON weighing mode.
<i>F 9</i>	Serial data output method.
<i>F R</i>	Serial data baud rate.
<i>F b</i>	Comparator buzzer settings.
<i>F [</i>	TARGET weighing analog display mode.



# Changing the Function Settings

1

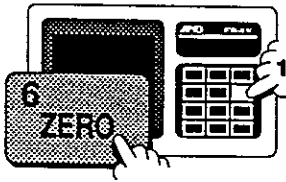

- ▶ With the display OFF:  
Press and hold the **ZERO** key.

2

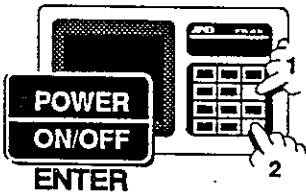

- ▶ While holding the **ZERO** key  
press the **POWER ON/OFF** key for 2  
seconds.
- The display will show Function F1  
and it's setting.

F 1 1

3

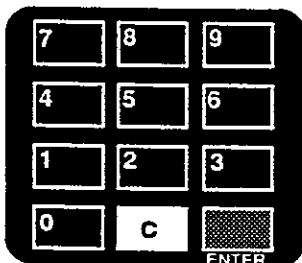

- ⚠ If you wish to change the setting for  
this Function then use the keypad  
numbers.

- ▶ For example press **2** to set F1 to 2.

F 1 2

- The display will show the number  
you press.

4



- ▶ Press the **POWER ON/OFF** key.
- The display will show the next Function  
and it's setting.

F 2 7



- ▶ Carry on in this manner, repeating steps 3 and  
4 until the setting for the final Function **F<sub>n</sub>** is  
made.

- The scale will now store the Function settings  
and perform a power up display test.



# The F-Function Settings

Ⓢ Denotes Factory Setting.

**F 1**

## Comparator Condition

This Function sets the conditions under which the comparator will make a decision, on the weight on the display, and show the result.

Ⓢ 0	Comparator OFF.
1	Compare when weight stable or moving.
2	Compare when weight is stable. (STBL annunciator lit.)
3	Compare when weight stable or moving <b>and</b> more than +/- 4 grads away from zero.
4	Compare when weight stable <b>and</b> +/- 4 grads away from zero.
5	Compare when weight stable or moving <b>and</b> more than 4 grads above zero.
6	Compare when weight stable <b>and</b> more than 5 grads above zero.

**F2****Liquid Crystal Display Selection**

This Function allows you to select which part(s) of the display area you wish to function.

	DIGITAL (U.S.A. only)	COMPARATOR	ANALOG
0	on	on	on
1	on	off	off
2	off	on	off
3	on	on	off
4	off	off	on
5	on	off	on
6	off	on	on
⑦ 7	on	on	on

**F3****LIMIT Sweep Display Magnification**

This Function allows you to select how many graduations, of the low range, are represented by one division of the analog sweep display.

1 to 10	<p>The number you set in this Function is multiplied by the graduation of the low range to set the weight change represented by one division on the analog sweep display when in the LIMIT weighing mode.</p> <p>For example on an FS-6K Metric scale the low range is 3kg x 0.001kg. If function F3 is set to 5 then each division of the analog sweep display represents 5 x 0.001kg i.e. 5 grams.</p>
---------------	--

⑦ Factory setting is 1

F4

## UNIT Selection (U.S.A. Only)

This Function allows you to select how many of the available weight units your scale will use. *This function is inactive on a Metric scale set up.*

		kg	lb -oz	oz	lb
	1	off	off	off	on
	2	off	off	on	off
	3	off	off	on	on
	4	off	on	off	off
	5	off	on	off	on
	6	off	on	on	off
	7	off	on	on	on
	8	on	off	off	off
	9	on	off	off	on
	10	on	off	on	off
	11	on	off	on	on
	12	on	on	off	off
	13	on	on	off	on
	14	on	on	on	off
Ⓢ	15	on	on	on	on

**F5****Automatic Power Down**

This Function enables or disables the automatic power down feature.

- ⚠ If set, the scale will automatically power down, if the weight has been near to zero and stable for a 3 minute period.
- ⚠ If the scale stays stable and near zero from switch ON then the power down will occur after 6 minutes.

0	Power down timer OFF.
1	Power down timer ON.

**F6****Front Panel Key Lockout**

This Function allows you to lock out some or all of the front panel keys.

0	All keys and facilities are available.
1	<b>ZERO</b> , <b>TARE</b> and <b>POWER ON/OFF</b> are available . Limits can be viewed but <b>not</b> amended. Comparator memory slots cannot be accessed.
2	<b>ZERO</b> , <b>TARE</b> and <b>POWER ON/OFF</b> are available . Limits can be viewed and amended. Comparator memory slots cannot be accessed.

**F7****Scale Response Speed**

This Function allows you to select the electronic response of the scale to changing weights. The faster the response setting the more susceptible the scale will be to vibration. This Function would normally be set to suit the site conditions.

0	Fast response.
1	Normal average response.
2	Slow response.

**F8** **Power ON Weighing Mode**

This Function allows you to select the weighing mode in which your scale will be when switched ON.

0	Simple weighing mode.
1	Limit check weighing mode.
2	Target weighing mode.

**F9** **Serial Data Output Method**

This Function allows you to select the method by which serial data will be transmitted.

0	Sent when <b>PRINT</b> key pressed.
1	Stream mode.
2	Automatic print mode.

**FA** **Serial Data Baud Rate**

This Function allows you to select the baud rate for the serial data interface on option OP-03.

0	600 bits per second.
1	1200 bits per second
2	2400 bits per second
3	4800 bits per second

**Fb****Comparator Buzzer**

This Function allows you to select the conditions under which the buzzer will operate.

0	Buzzer OFF.
1	Operates on - only.
2	Operates on ok only.
3	Operates on - and on ok.
4	Operates on + only.
5	Operates on - and on +.
6	Operates on ok and on +.
7	Operates on - on ok and on +.

**Fc****Analog Sweep Display Mode**

This Function allows you to select , in TARGET weighing mode, the type of analog display.

0	Normal Mode.
1	Percentage Mode.

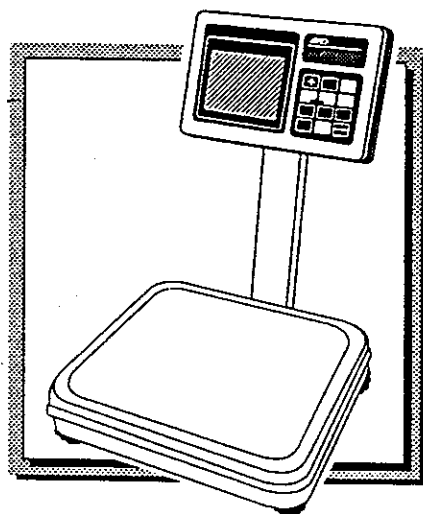

## FS/FS-KL Series • Section I

# OP-03 RS-232C Serial Interface & Relay Option



# OP-03 Installation

- 1**  Switch the scale OFF and unplug the A.C. adaptor.

- 2**  Remove the battery compartment cover by unscrewing the 2 knurled screws and then pulling the cover free.

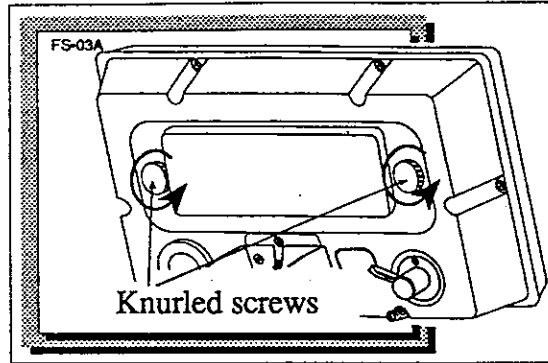

- 3**  Set the option board jumper to suit your application .

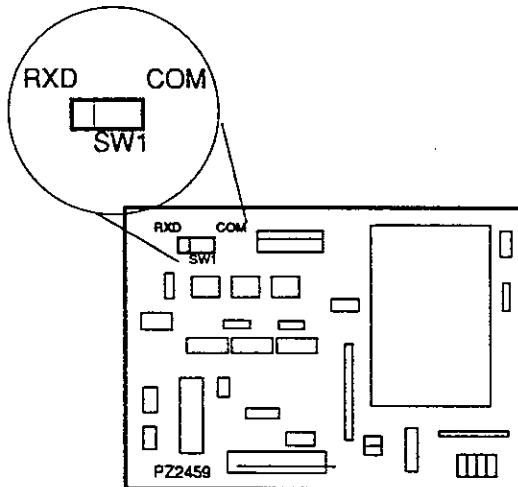

- Position **COM** if you are to use the comparator output relays

OR

- Position **RXD** if you are to use Command Mode on the RS232C.

- 4** Plug the option board into the main board connectors J2 and J3 as shown.

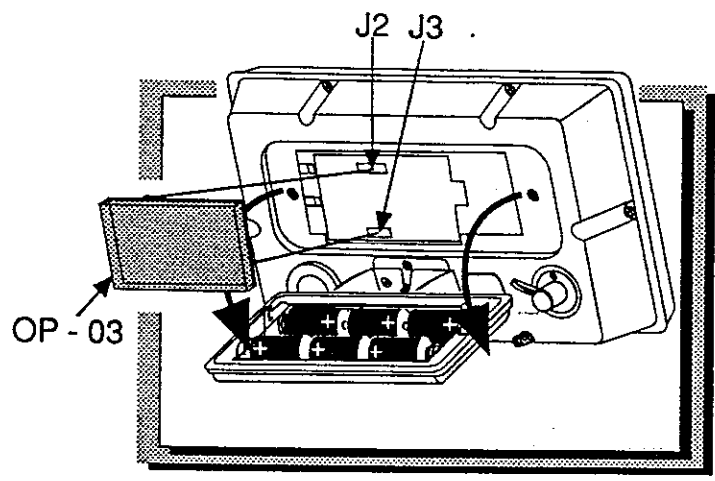

- 5** Replace the battery compartment cover removed in step 2.

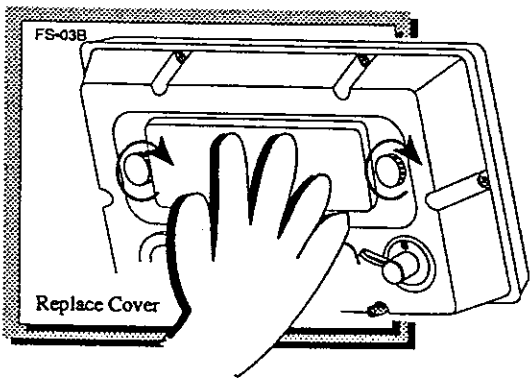

- 6** Remove the blanking plug from the rear of the display case to reveal the option output connector.

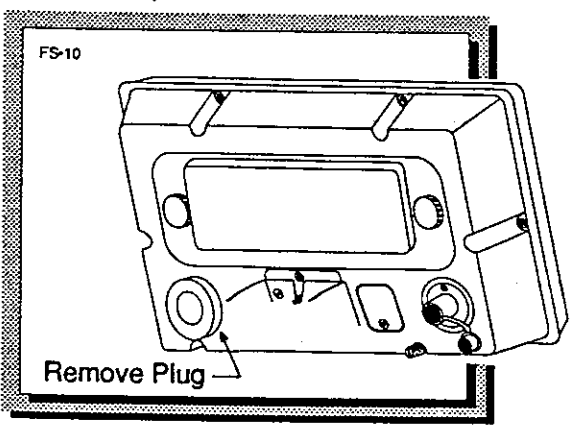

# Specifications

**Type** EIA-RS-232C  
**Method** Asynchronous Transmission, Bi-directional  
**Format** Baud rate: 600, 1200, 2400 and 4800 baud. Selected by Function F-A See Page H-7.  
**Data bit** 7.  
**Parity** Even.  
**Stop bit** 1.  
**Code** ASCII.

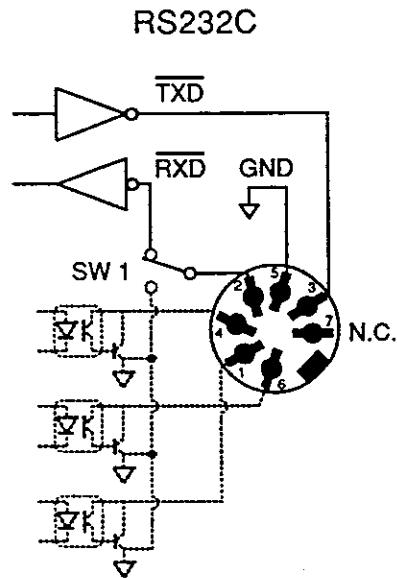
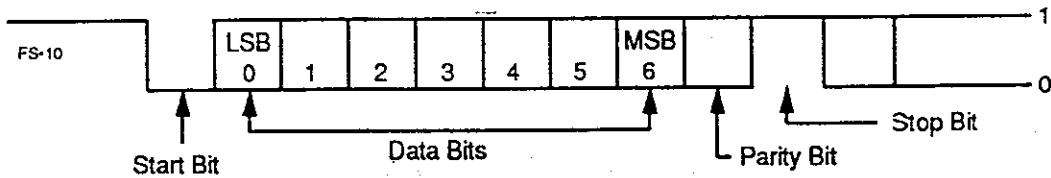



## Data Format

The data string is in standard A&D format and consists of :  
Header + Data +Unit +cr.  
e.g. **ST,+00010.00,kg**

There are three types of header:

**ST** - The weight reading is stable.

**US** - The weight reading is unstable.

**OL** - The scale is overloaded.

The Data consists of 9 characters including sign and decimal point.

The unit is **kg** except in the U.S. version where the unit can be

**lb** - when the scale unit is pounds.

**oz** - when the scale unit is ounces.

**kg** - when the scale unit is kilogrammes.

**lb-oz** - when the scale unit is pounds and ounces.

The terminator, cr, is the ASCII carriage return character [0D<sub>HEX</sub>].



## Data Output Method

Function F-9 , (See Page H• 7 ) controls when the output string is transmitted. Three methods are available.

- |         |                      |  |
|---------|----------------------|--|
| F-9 = 0 | Key Mode             | Whenever the <b>PRINT</b> key is pressed and the data is stable then one data string will be sent.   |
| F-9 = 1 | Stream Mode          | Data will be sent continuously at about 5 times per second.  |
| F-9 = 2 | Automatic Print Mode | If the weight changes from near zero by more than 5 (low range) graduations and becomes stable above zero then one data string will be sent. |



Regardless of the setting of Function F-9 the Commands Q and S will still work if the option switch is set to position 2 - Command Mode.



## Command Mode

With the OP-03 switch set to position **RXD** the following commands are available to computer operation.

<b>@</b>	This command will toggle the STREAM mode ON/OFF.
<b>A</b>	This command will clear any stored TARE value.
<b>C</b>	<p>This command will allow a remote device to read/write the current comparator settings.</p> <p>If the remote device sends a character <b>C</b> the response from the scale will be :-</p> <p style="text-align: center;"><b>C,tttt,hhhh,IIII</b></p> <p>If the remote device sends a string of characters :-</p> <p style="text-align: center;"><b>C,C,tttt,hhhh,IIII</b></p> <p>the scale will write these values into the comparator.</p> <p>In both cases <b>tttt</b> is the target ok weight, <b>hhhh</b> is the upper + limit and <b>IIII</b> is the lower - limit. Each group consists of 5 unsigned numeric digits.</p>
<b>F</b>	<p>This command allows a remote device to read/write the function settings in the scale.</p> <p>If the remote device sends <b>F</b> the scale will respond with :-</p> <p style="text-align: center;"><b>F,123456789ABC</b></p> <p>If the remote device sends a string of characters :-</p> <p style="text-align: center;"><b>F,C,123456789ABC</b></p> <p>the scale will write these function settings into the scale.</p> <p>In both cases the string <b>123456789ABC</b> represents the Functions <b>F1</b> thro' <b>FC</b>. Each digit position can have a value <b>0</b> thro' <b>F</b> but only certain values are meaningful. See Section H - Functions.</p>
<b>P</b>	This command will allow a remote device to switch off the scale power as if the front panel <b>POWER</b> key had been pressed.
<b>Q</b>	This command will cause the scale to immediately send one data string.
<b>S</b>	This command will cause the scale to send one data string as soon as the weight becomes stable.
<b>T</b>	This command will cause the scale display to tare as if the front panel <b>TARE</b> key had been pressed.

<p><b>U</b></p>	<p>This command will cause the unit in use to cycle through the available weighing units.e.g. :-</p> <p style="text-align: center;"><b>lb-&gt;oz-&gt;lb-oz-&gt;kg</b></p> <p>Note:- Availability of units depends on country of use.</p>
<p><b>V</b></p>	<p>This command will cause the scale to send the software version in use. The format is :-</p> <p style="text-align: center;"><b>FS02,OP01</b></p> <p>where the first 4 digits show the FS/FS-KL main processor version and the latter 4 digits show the OP-03 processor version.</p>
<p><b>W</b></p>	<p>This command allows a remote device to store the current comparator limits into a selected comparator memory slot. The format is :-</p> <p style="text-align: center;"><b>W,i</b></p> <p>where i is the memory slot number and must be between 1 and 8.</p>
<p><b>Z</b></p>	<p>This command will cause the scale display to zero as if the front panel <b>ZERO</b> key had been pressed.</p>
<p></p>	<p>All of these commands must be followed by either a carriage return character or by carriage return line feed characters.</p>



# Comparator Output Relays

- The Option OP-03 provides three relays which duplicate the front panel annunciators **—**, **+—** and **OK**.

The relays are rated at 125 volts (A.C. or D.C.) 50 mA **maximum** and have an ON contact resistance of less than 8 ohms.



These output relays are only available if the option OP-03 switch is set to position COM.

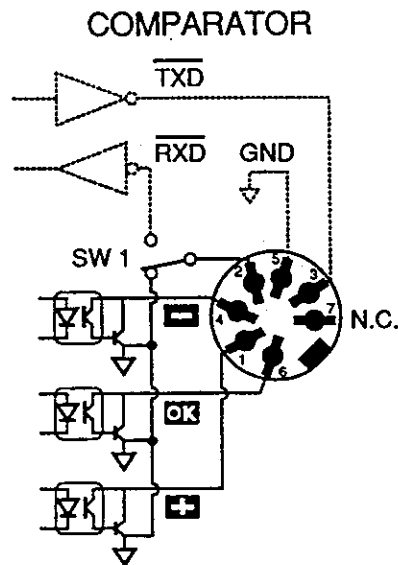

- Pin 1 Comparator **+—** output function.
- Pin 2 Comparator output common. (*RXD input in Command Mode.*)
- Pin 3 RS232C output TXD.
- Pin 4 Comparator **—** output function.
- Pin 5 Ground connection for RS232C transmission.
- Pin 6 Comparator **OK** output function.
- Pin 7 Not connected.

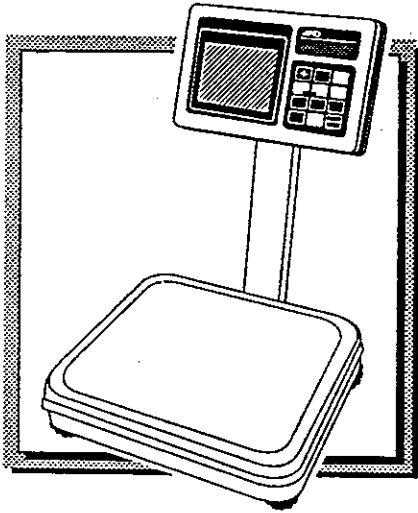

**FS/FS-KL Series • Section AP**

Appendix





## Additional Cal. & Gravity Info.



### Gravity Compensation



This additional information is intended for those users that are working with gravity variations, such as scale shipment over a long distance after calibration. It is solely for this use (when the FS/FS-KL scale is to be transported to a different geographical area), and it is not intended, nor needed for local or on-site calibration. In other words: *Don't worry about it unless you need it.*



As stated earlier, calibration of the FS/FS-KL is required when it is initially installed, if it is moved often, or if it is moved a substantial distance. Gravity compensation can be necessary because the weight of a mass in one location is not necessarily the same in another location. "Weight" equals mass times acceleration due to Earth's field of gravity. The internationally adopted value for gravitational acceleration is  $9.80665 \text{ m/s}^2$  ( $32.174 \text{ ft/s}^2$ ) in a vacuum. However, this varies by about  $\pm 0.3$  percent depending on how far you are from the Earth's center of mass. Mass distorts space in such a way that the gravitational power of attraction is inversely proportional to the square of the distance between material objects (if non-gravitational forces are ignored).

When we weigh a mass, we are trying to find its weight expressed in pounds or kilograms. Because "g" and other factors vary from location to location, we must calibrate the FS/FS-KL whenever we move it. Otherwise, a mass of 30kg might display 30.00kg in one location and 30.08kg in another (ie: "g" may have changed by +0.267%.  $w=m \times g$ ). This would be an error, but it can be prevented by placing an accurate mass on the weighing device (say 30kg) and then telling the FS/FS-KL, in effect, "this is what 30kg weighs at this location so please display 30.00kg"..... this is calibration.

- It is best to set the "g" with the actual value of gravity, measured at the location. This can be found in reference tables for the country (or area), or sometimes from a physics laboratory at a local academic institution. Also, if you know the latitude and altitude, you can use the following formula:

*Helmert's formula can be used to find the value of "g", the acceleration due to terrestrial gravity, for a given latitude and altitude:*

$$g = 9.806\ 16 - 0.025\ 928 \cos 2\lambda + 0.000\ 069 \cos^2 2\lambda - 0.000\ 003\ 086H$$

"g" is in  $\text{m/s}^2$ , " $\lambda$ " means latitude and "H" is meters above sea level.

- Alternatively, please refer to the attached table for the value of "g" at various world wide locations or plot the end-user's position in terms of latitude and altitude on the enclosed graph (see pp.AP•3-4).



# Gravity Values at Various Locations

Amsterdam	9.813	m/s <sup>2</sup>	Manila	9.784	m/s <sup>2</sup>
Athens	9.800	m/s <sup>2</sup>	Melbourne	9.800	m/s <sup>2</sup>
Auckland NZ	9.799	m/s <sup>2</sup>	Mexico City	9.779	m/s <sup>2</sup>
Bangkok	9.783	m/s <sup>2</sup>	Milan	9.806	m/s <sup>2</sup>
Birmingham	9.813	m/s <sup>2</sup>	New York	9.802	m/s <sup>2</sup>
Brussels	9.811	m/s <sup>2</sup>	Oslo	9.819	m/s <sup>2</sup>
Buenos Aires	9.797	m/s <sup>2</sup>	Ottawa	9.806	m/s <sup>2</sup>
Calcutta	9.788	m/s <sup>2</sup>	Paris	9.809	m/s <sup>2</sup>
Capetown	9.796	m/s <sup>2</sup>	Rio de Janeiro	9.788	m/s <sup>2</sup>
Chicago	9.803	m/s <sup>2</sup>	Rome	9.803	m/s <sup>2</sup>
Copenhagen	9.815	m/s <sup>2</sup>	San Francisco	9.800	m/s <sup>2</sup>
Cyprus	9.797	m/s <sup>2</sup>	Singapore	9.781	m/s <sup>2</sup>
Djakarta	9.781	m/s <sup>2</sup>	Stockholm	9.818	m/s <sup>2</sup>
Frankfurt	9.810	m/s <sup>2</sup>	Sydney	9.797	m/s <sup>2</sup>
Glasgow	9.816	m/s <sup>2</sup>	Taichung	9.789	m/s <sup>2</sup>
Havana	9.788	m/s <sup>2</sup>	Taiwan	9.788	m/s <sup>2</sup>
Helsinki	9.819	m/s <sup>2</sup>	Taipei	9.790	m/s <sup>2</sup>
Kuwait	9.793	m/s <sup>2</sup>	Tokyo	9.798	m/s <sup>2</sup>
Lisbon	9.801	m/s <sup>2</sup>	Vancouver, BC	9.809	m/s <sup>2</sup>
London (Greenwich)	9.812	m/s <sup>2</sup>	Washington DC	9.801	m/s <sup>2</sup>
Los Angeles	9.796	m/s <sup>2</sup>	Wellington NZ	9.803	m/s <sup>2</sup>
Madrid	9.800	m/s <sup>2</sup>	Zurich	9.807	m/s <sup>2</sup>



# Acceleration Due to Gravity Table

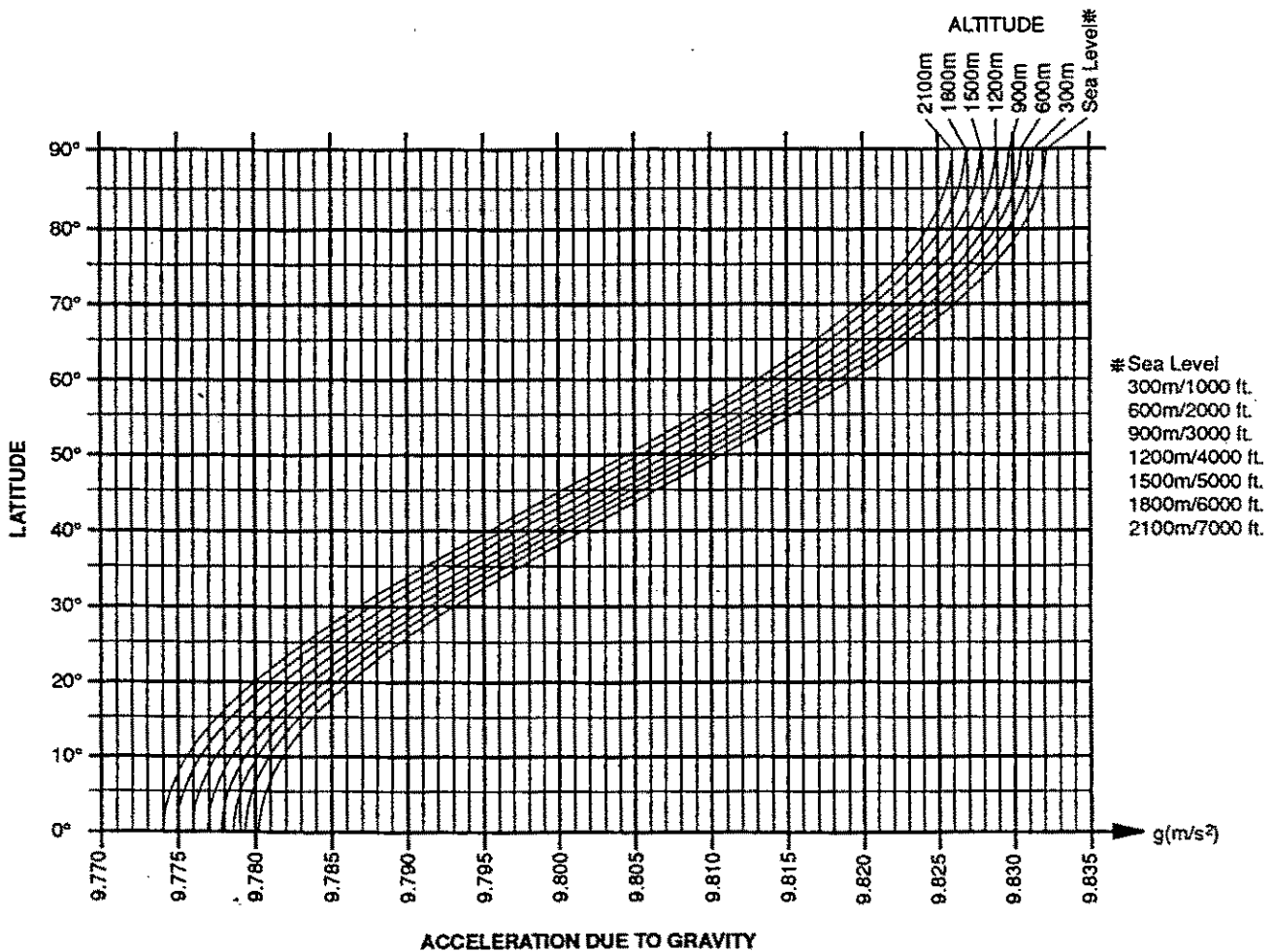



# World Map

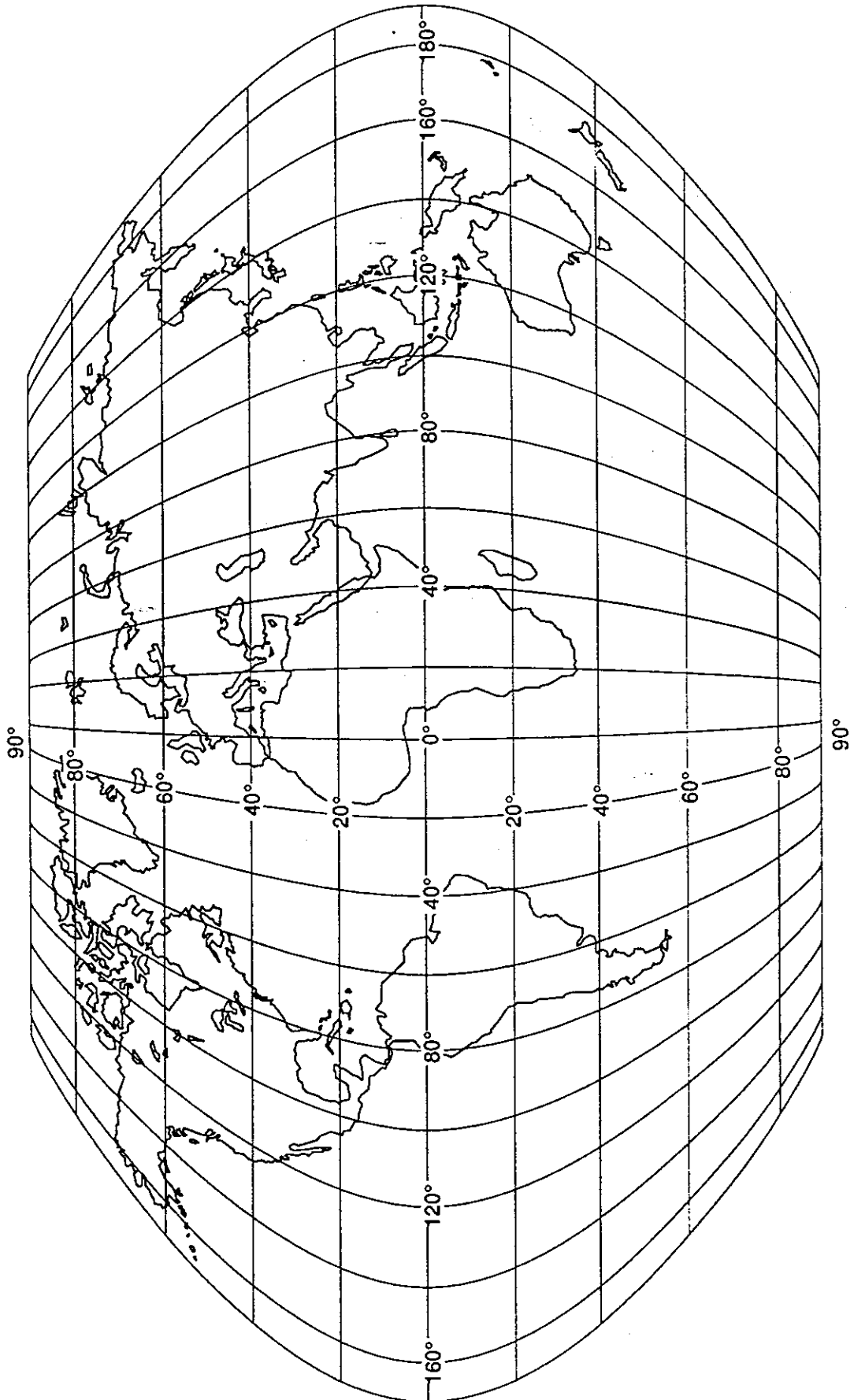





**A&D Company, Limited**

3-23-14 Higashi-Ikebukuro, Toshima-ku, Tokyo 170 Japan  
Telephone: [81] (03) 5391-6132 Fax: [81] (03) 5391-6148 Telex: 2422816 AANDD J

**A&D ENGINEERING, INC.**

1555 McCandless Drive, Milpitas, CA. 95035 U.S.A.  
Telephone: [1] (408) 263-5333 Fax: [1] (408) 263-0119

**A&D INSTRUMENTS LTD**

Abingdon Science Park, Abingdon, Oxford OX14 3YS England  
Telephone: [44] (0235) 550420 Fax: [44] (0235) 550485

**A&D MERCURY PTY. LTD.**

32 Dew Street, Thebarton, South Australia 5031 Australia  
Telephone: [61] (08) 352-3033 Fax: [61] (08) 352-7409

**A&D KOREA Limited**

3rd Floor Hanam Bldg 44-27 Yoido-dong Youndeungpo-ku Seoul, Korea  
Telephone: [82] (02) 784-4264 Fax: [82] (02) 784-6557