

GXA-14

INSTRUCTION MANUAL

DENSITY DETERMINATION KIT

GX-124AE/GX-224AE/GX-324AE

GX-124A/GX-224A/GX-324A

GF-124A/GF-224A/GF-324A

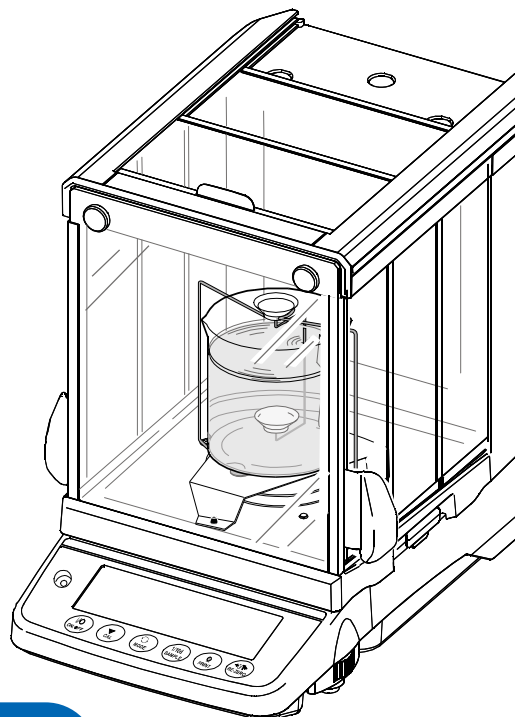



AND

A&D Company, Ltd.

This Manual and Marks

Product Safety Signs and Labels

All safety messages are identified by the following, "WARNING" or "CAUTION", of ANSI Z535.4 (American National Standard Institute: Product Safety Signs and Labels). The meanings are as follows:

 WARNING	A potentially hazardous situation which, if not avoided, could result in death or serious injury.
 CAUTION	A potentially hazardous situation which, if not avoided, may result in minor or moderate injury.
Note	Provides information useful for the user to operate the instrument.

 This is a hazard alert mark.

Note

- This manual is subject to change without notice at any time to improve the product.
- The contents of this manual and the specifications of the instrument covered by this manual are subject to change for improvement without notice.

© 2019 A&D Company Ltd. All rights reserved.

No part of this publication may be reproduced, transmitted, transcribed, or translated into any language in any form by any means without the written permission of A&D Company Ltd.

Contents

1. INTRODUCTION	4
1-1. Precautions.....	4
2. UNPACKING THE KIT	4
3. DENSITY MEASUREMENT PRINCIPLES	5
3-1. Density	5
3-2. Specific Gravity	5
3-3. Archimedes' Principle Of Density Measurement	5
3-4. Density Of A Solid	5
3-5. Density Of A Liquid.....	5
4. ERROR FACTORS	6
4-1. Buoyancy Of Air.....	6
4-2. Volume Of Float.....	6
4-3. Temperature Of Liquid	6
4-4. Influence Of Wire	6
4-5. Surface Tension.....	7
4-6. Bubbles	7
5. MEASURING THE DENSITY OF A SOLID	8
5-1. Assembling The Kit	8
5-2. Measuring The Density Of A Solid	9
6. MEASURING THE DENSITY OF A LIQUID	11
6-1. Assembling The Kit:	11
6-2. Measuring The Density Of A Liquid.....	11
7. DENSITY MEASUREMENT USING THE GX-A / GF-A BALANCE	13
7-1. Preparation Before Measurement (Settings of the Function Table)	14
7-2. Measuring Solid Density (Specific Gravity), Function Table $dS \square$	20
7-3. Specifying Liquid Density	23
7-4. Measuring Liquid Density (Specific Gravity), Function Table $dS l$	26
7-5. Specifying Volume of Float.....	29
8. FREQUENTLY ASKED QUESTIONS	31
9. WATER RESISTANT DIGITAL THERMOMETER AD-5625	32
9-1. For Safe Use.....	32
9-2. Precautions When Handling	32
9-3. Each Part Name	33
9-4. Replacing The Battery	34
9-5. Operating the Thermometer	35
9-6. Daily Care.....	38
9-7. Specifications	38

1. Introduction

Thank you for your A&D purchase! This is the instruction manual for the density determination kit.

The density determination kit can be easily used to measure the density of solid or liquid when it is combined with the following electronic balances.

GX-124AE/GX-224AE/GX-324AE

GX-124A/GX-224A/GX-324A

GF-124A/GF-224A/GF-324A

Before using the density determination kit, please read this instruction manual thoroughly.

1-1. Precautions

- This density determination kit allows the density or specific gravity of a solid or liquid to be measured. However, the results of measurements may be affected by various factors that could cause errors, therefore we cannot guarantee them to be 100 % accurate.
- Do not use the density determination kit for measuring the density of chemically active substances.
- After using the density determination kit, clean all surfaces to remove rust and oxides.
- The balance is precision instrument, so avoid shocks or excessive loads.
- To improve measuring accuracy, allow the temperature of liquid (water) and sample (solid) to equalize to the ambient room temperature and perform measurement in a stable environment.

2. Unpacking The Kit



Float

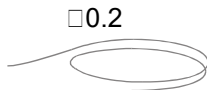

Wire

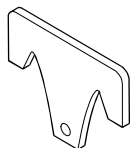

Float hook



Thermometer clamp

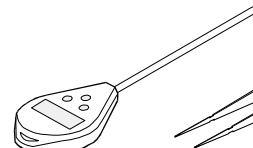

Thermometer

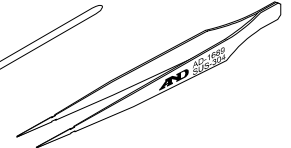

Tweezers

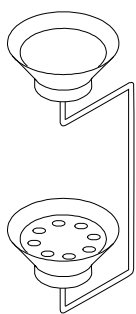

Density pan

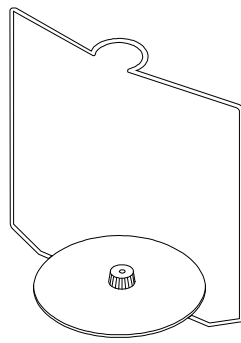

Density pan stand

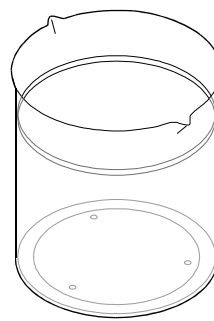

Liquid container
PMP Beaker

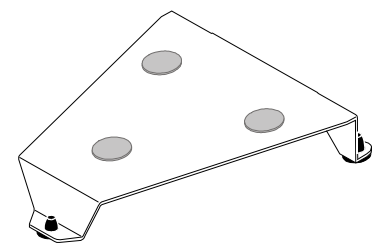

Beaker stand

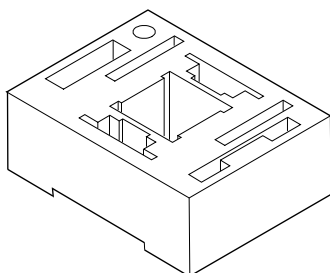

Kit box

Stores the kit after use.

3. Density Measurement Principles

3-1. Density

Density refers to the total mass of a sample per unit volume.

$$\rho = \frac{M}{V} \quad (\text{Unit: g/cm}^3)$$

ρ : Density of sample (g/cm³)
 M : Mass (g)
 V : Volume (cm³)

3-2. Specific Gravity

Specific gravity refers to the ratio of the density of a sample to the density of pure water at 4°C under a pressure of 1013.25 hPa.

$$\rho = \frac{M}{V \times \rho_4} \quad (\text{No unit})$$

ρ : Density of sample (g/cm³)
 M : Mass (g)
 V : Volume (cm³)
 ρ_4 : Density of water at 4°C
(0.99997 g/cm³ □ 1.000 g/cm³)

3-3. Archimedes' Principle Of Density Measurement

The GXA-14 is combined with an electronic balance to measure the density of a sample based on the Archimedes' principle.

Archimedes' principle

A body immersed in a liquid (or a gas) is subject to an upward force equal to the weight of the liquid (or the gas) it displaces. The upward force is buoyancy.

3-4. Density Of A Solid

The density of a solid can be obtained according to the weight of the sample in air, the weight of the sample in liquid and the density of the liquid.

$$\rho = \frac{A}{A - B} \times (\rho_0 - d) + d$$

ρ : Density of sample (g/cm³)
 A : Weight of sample in air (g)
 B : Weight of sample in liquid (g)
 ρ_0 : Density of liquid (g/cm³)
 d : Density of air (approx. 0.001 g/cm³)

3-5. Density Of A Liquid

The density of a liquid can be obtained according to the weight of float in air, the weight of float in liquid and the known volume of float.

$$\rho = \frac{A - B}{V} + d$$

ρ : Density of liquid (g/cm³)
 A : Weight of float in air (g)
 B : Weight of float in liquid (g)
 V : Volume of float (cm³)
 d : Density of air (approx. 0.001 g/cm³)

4. Error Factors

The results of measurements may be affected by various factors that could cause errors

4-1. Buoyancy Of Air

- A density measurement is influenced by an upward force of 0.0010 to 0.0014 g/cm³ (buoyancy of air).
- The density of air can be obtained by the equation below:

$$d = \frac{0.0012932}{1 + 0.0036728 \times t} \times \frac{P}{1013.25}$$

d : Density of air (g/cm³)
t : Air temperature (°C)
P : Atmospheric pressure (hPa)

- When measurement accuracy of three significant digits is necessary, consider the buoyancy of air, add 0.001 g/cm³ to the measured value to compensate for the error due to the air density.

4-2. Volume Of Float

- The tolerance of the measured value of the volume of the float is ±0.01 cm³.
In liquid density measurement, the decimal places beyond the third decimal place of the measured value contain errors.
- When measurement accuracy to the third decimal place or beyond is necessary, measure the volume of the float using distilled water.

$$V = \frac{A - B}{\rho - d} - 0.0035$$

- V : Volume of float (cm³)
A : Mass of float in air (g)
B : Mass of float in liquid (g)
ρ : Density of distilled water at t °C (g/cm³)
d : Density of air at t °C (g/cm³)
0.0035 : Correction value for the wire (diameter of 1 mm) of the density pan connecting the upper and lower pans (when the beaker provided with this kit is used)

4-3. Temperature Of Liquid

- The density of the liquid that is used for measuring the density of a solid varies with the liquid temperature. Therefore, the decimal places beyond the second decimal place of the measured value contain errors.
- Obtain the density of a liquid according to the temperature from [Table 1](#) for distilled water or from other reference documents for other liquids.
- When measurement accuracy to the third decimal place or beyond is necessary, use a thermometer with a tolerance of ±0.2 °C or less.

4-4. Influence Of Wire

- In solid density measurement, the surface of the liquid rises when a solid sample is placed on the density pan, which is immersed in the liquid. At this time, the buoyancy corresponding to the weight of the raised liquid is exerted on the wire (diameter of 1 mm) connecting the upper and lower density pans. If the surface of the liquid rises 1 mm, the buoyancy exerted on the wire is about 0.8 g/cm³. To minimize the error due to the buoyancy, select a sample with a smaller volume or correct the value by calculation.

- In liquid density measurement, a force (buoyancy) is exerted on the wire (diameter of 0.2 mm) suspending the float, when immersed in the liquid. Immersing the wire by 10 mm exerts a buoyancy of about 0.3 mg on the wire. However, this buoyancy influence can be ignored. When obtaining the liquid density, the difference between the weight of the float in air and in water is divided by the volume of the float, as described in “3-5. [Density Of A Liquid](#)”. This calculation reduces the error due to buoyancy such that it is negligible.

4–5. Surface Tension

- In solid density measurement, a force (surface tension) of about 5 mg is exerted on the pan between the wire (diameter of 1 mm) of the density pan and the liquid surface.
- The surface tension can be reduced by about 1 mg by adding a surfactant (for example, a wetting agent used for developing photographs). Adding 0.1 mL (density: 1.2 g/cm³) of a surfactant to 200 mL of water will increase the density of water by about 0.0001 g/cm³.
- In liquid density measurement, a force (surface tension) of about 1 mg is exerted on the wire (diameter of 0.2 mm) suspending the float. However, this surface tension influence can be ignored. When obtaining the liquid density, the difference between the weight of the float in air and in water is divided by the volume of the float, as described in “6. [Measuring The Density Of A Liquid](#)”. This calculation reduces the error due to surface tension such that it is negligible.

4–6. Bubbles

- The buoyancy of a bubble of 1 mm in diameter is about 0.5 mg. Bubble generation depends on the shape and material of the sample, so take care when making measurements.
- In solid density measurement, a surfactant may be added to reduce the influence of bubbles.

5. Measuring The Density Of A Solid

Assemble the kit as described in the procedure below.

5-1. Assembling The Kit

1. Remove the weighing pan and breeze break ring from the balance.
 2. Place the density pan stand on the balance.
 3. Place the beaker stand so that it does not touch the density pan stand.
 4. Attach the thermometer clamp to the beaker and insert the thermometer into the thermometer clamp.
 5. Pour a liquid with a known density (such as distilled water) into the beaker and place the beaker on the beaker stand.
 6. Place the density pan on the density pan stand.
 7. Adjust the amount of the liquid so that the sample, when placed on the lower pan (in the liquid), is about 10 mm below the surface of the liquid.
 8. When the value displayed on the balance is stable, press the **RE-ZERO** key to set the displayed value to zero. Now the balance is ready for density measurement.
- GX-AE / GX-A / GF-A series balances are equipped with a density mode to calculate the density of a solid. For details, refer to the instruction manual of GX-AE / GX-A / GF-A series.

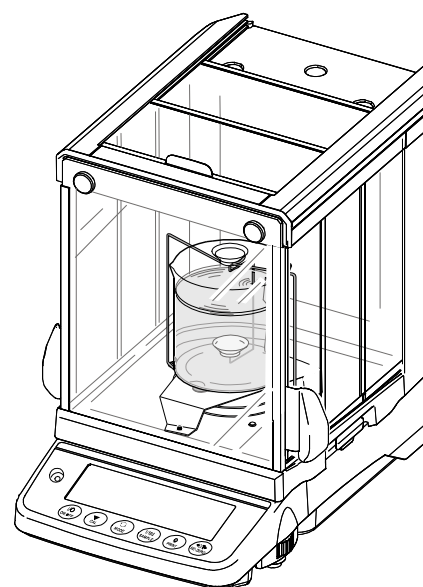
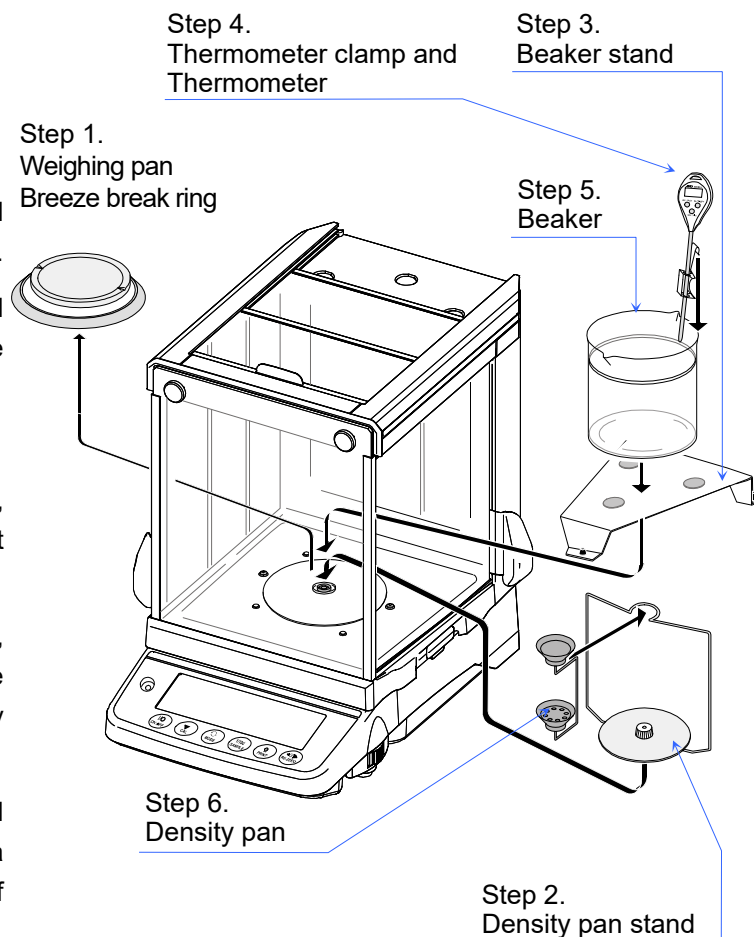

GX-A series
for density measurement

5-2. Measuring The Density Of A Solid

□ The density of a solid is obtained by averaging the measured values.

1. Start the measurement when water temperature becomes stable.
2. Press the **RE-ZERO** key to set the displayed value to zero.
3. Place the sample on the upper pan in air and record the value A.
4. Press the **RE-ZERO** key to set the displayed value to zero.
5. Place the sample on the lower pan in liquid and record the value B.
 - Keep the depth of approximately 10 mm under liquid surface.
6. Obtain the density of water according to the temperature. (Refer to [Table 1](#))

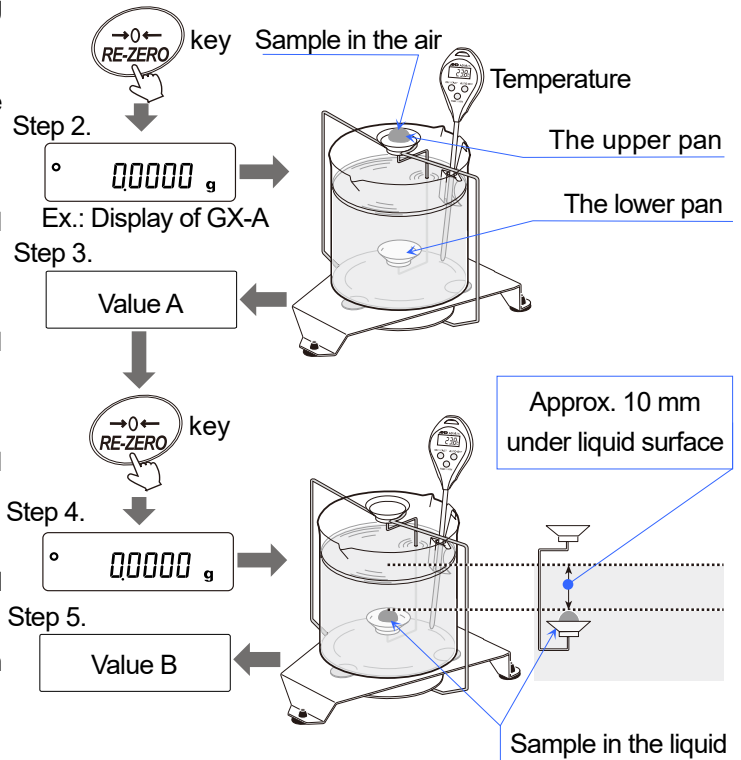

Table 1 Density of distilled water

Temperature °C	+0	+1	+2	+3	+4	+5	+6	+7	+8	+9
0	0.99984	0.99990	0.99994	0.99996	0.99997	0.99996	0.99994	0.99990	0.99985	0.99978
10	0.99970	0.99961	0.99949	0.99938	0.99924	0.99910	0.99894	0.99877	0.99860	0.99841
20	0.99820	0.99799	0.99777	0.99754	0.99730	0.99704	0.99678	0.99651	0.99623	0.99594
30	0.99565	0.99534	0.99503	0.99470	0.99437	0.99403	0.99368	0.99333	0.99297	0.99259
40	0.99222	0.99183	0.99144	0.99104	0.99063	0.99021	0.98979	0.98936	0.98893	0.98849

At sea level (1 atmosphere), the density of water reaches maximum at 3.98 °C.

Unit: g/cm³

7. Use the following equations to obtain the density.

Three significant digits:

$$\rho = \frac{A}{A - B} \times \rho^0$$

Four or more significant digits:

$$\rho = \frac{A}{A - B} \times (\rho^0 - d) + d$$

ρ : Density of sample (g/cm³)

A : Value A : Weight of sample in air (g)

B : Value B : Weight of sample in liquid (g)

ρ^0 : Density of liquid (g/cm³)

d : Density of air (approx. 0.001 g/cm³)

Example of recording sheet

Value A : Weight of sample in air (g)	4.8102 g
Value B : Weight of sample in liquid (g)	4.2156 g
Temperature of liquid (°C)	26 °C
Density of liquid (g/cm ³)	0.99678 g/cm ³
$\rho = \frac{\text{Weight of sample in air}}{\text{Weight of sample in air} - \text{Weight of sample in liquid}} \times \text{Density of liquid (g/cm}^3\text{)}$	8.06 g/cm ³ (Calculated)

Value A : Weight of sample in air (g)	4.8102 g
Value B : Weight of sample in liquid (g)	4.2156 g
Temperature of liquid (°C)	26 °C
Density of liquid (g/cm ³)	0.99678 g/cm ³
Atmospheric pressure (hpa)	1013 hpa
Density of air (g/cm ³)	0.0012 g/cm ³
$\rho = \frac{\text{Weight of sample in air}}{\text{Weight of sample in air} - \text{Weight of sample in liquid}} \times (\text{Density of liquid} - \text{Density of air}) + \text{Density of air (g/cm}^3\text{)}$	8.055 g/cm ³ (Calculated)

6. Measuring The Density Of A Liquid

Assemble the kit as described in the procedure below.

6-1. Assembling The Kit:

1. For the procedure up to setting the beaker stand, refer to Step 1 to Step 3 in "5-1. Assembling The Kit".
2. Attach the thermometer clamp to the beaker and insert the thermometer into the thermometer clamp.
3. Place the beaker on the beaker stand.
4. Connect the float to the float hook using the wire. The length of wire must be approx. 30 mm.
5. Hook the float hook on the density pan stand.
6. This completes the preparations before measurement.

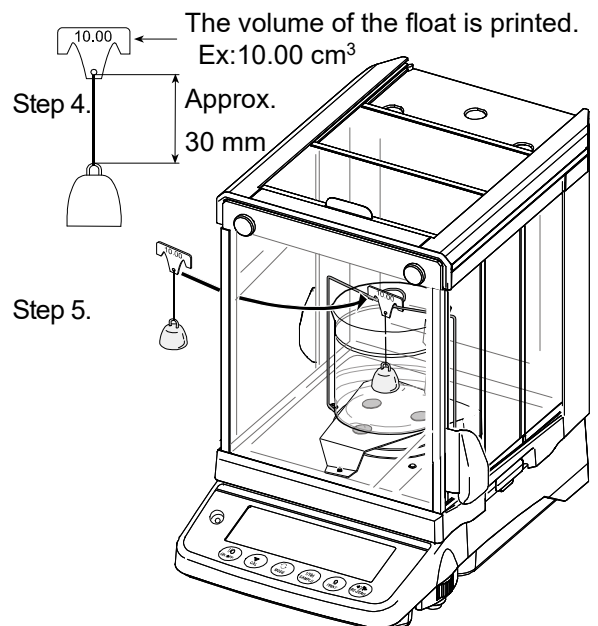

Example of the assembled GX-A series

6-2. Measuring The Density Of A Liquid

□ Use the following procedure to obtain the density of a liquid.

1. Press the **RE-ZERO** key to set the displayed value to zero.
2. Place the float, and then record its weight in the air.
Let the measured value be A.
3. Pour the liquid of which you want to measure the density into the beaker.
 - Make sure that the float is about 10 mm below the surface of the liquid.
4. When the display stabilizes, and then record its weight of the float in the liquid.
Let the measured value be B.
5. Use the following equations to obtain the density of the liquid.

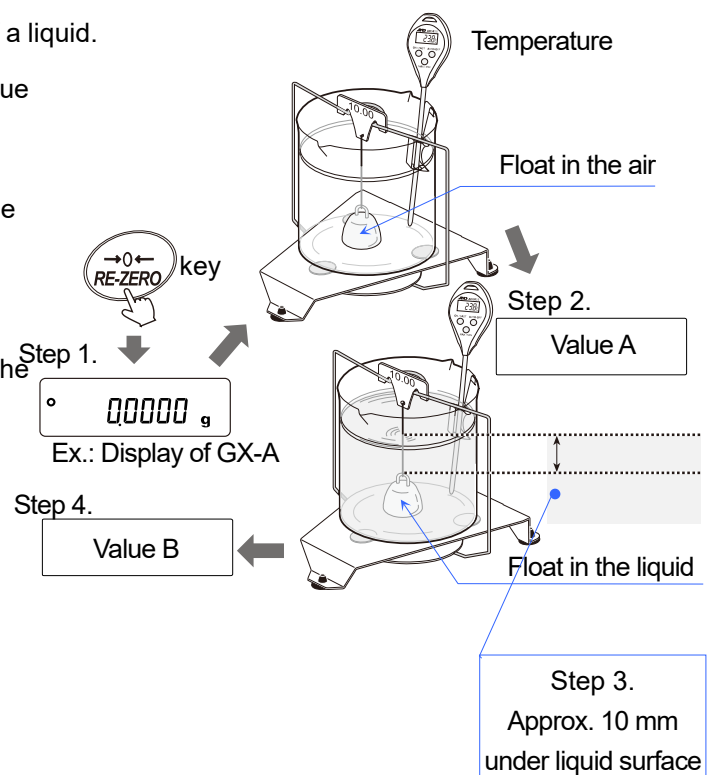

$$\rho = \frac{A - B}{V} + d$$

- ρ : Density of liquid (g/cm³)
 A : Weight of float in air – B : Weight of float in liquid (g)
 V : Volume of float (cm³)
 d : Density of air (approx. 0.001 g/cm³)

Example of recording sheet

Value A - B: Weight of float in air - Weight of float in liquid (g)	9.9704 g
Temperature of liquid (°C)	25 °C
Volume of float (g/cm ³)	10.01 cm ³
Density of air (g/cm ³)	0.001 g/cm ³
$\rho = \frac{\text{Weight of float in air} - \text{Weight of float in liquid}}{\text{Volume of float}} + \text{Density of air (g/cm}^3\text{)}$	0.997 g/cm ³ (Calculated)

7. Density Measurement Using the GX-A / GF-A Balance

- The GX-A / GF-A balances are equipped with a density function (specific gravity mode).
When this density determination kit GXA-14 is used with density function of the following balances, the density of a solid and liquid can be measured.
GX-124AE, GX-224AE, GX-324AE, GX-124A, GX-224A, GX-324A,
GF-124A, GF-224A, GF-324A

Caution

- The density function ($d5$ Func) of the balance cannot be selected when using factory settings.
The density function of the balance does not display in the function table when the specific gravity (SpG) of the weighing unit ($Unit$) is inactive. To use the specific gravity of the weighing unit, register "specific gravity" of "weighing unit" in the "function table" at first, and then select the specific gravity (SpG) of the weighing unit using the **MODE** key in weighing mode.
- When the liquid density input ($LdIn$) is active, the liquid density input ($LdIn$) or density of solid ($d5$) is displayed. Refer to the instruction manual of balance for operation method of the "function table".
- The measurement value of density (specific gravity) is fixed to 4 decimal places.







7-1. Preparation Before Measurement (Settings of the Function Table)



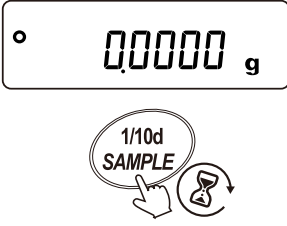

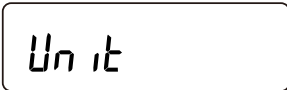

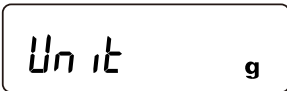

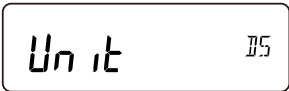

Set the function table of the balance before the density function (specific gravity mode) is used.

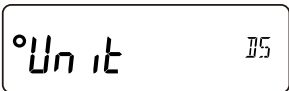
Enabling the Unit of Specific Gravity ($\frac{1}{10d}$)

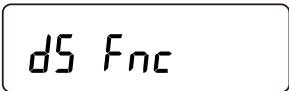
Register the specific gravity ($\frac{1}{10d}$) of the weighing unit ().





The following is an example of registering units in the order from **g** (grams) to $\frac{1}{10d}$ (specific gravity).

Step	Description	Display and Key Operation
1.	Press and hold (for about 2 seconds) the <input type="text" value="SAMPLE"/> key while the scale is in weighing mode. <input type="text" value="bASFnC"/> of the function table is displayed.	 <p>Press and hold (for about 2 seconds)</p> 
2.	Press the <input type="text" value="SAMPLE"/> key several times to display the weighing unit <input type="text" value="Unit"/> .	 <p>Press several times</p> 
3.	Press the <input type="text" value="PRINT"/> key to display <input type="text" value="Unit"/> g .	 
4.	Press the <input type="text" value="RE-ZERO"/> key to specify the unit and display the unit specification mark "◐".	 

Step	Description	Display and Key Operation
5.	Press the SAMPLE several times to display Unit $\frac{1}{10}$.	 <p>Press several times</p> 
6.	Press the RE-ZERO key to specify the unit and display the unit specification mark "°".	 
7.	Press the PRINT key to register the specified unit.	 
8.	Press the CAL key to return to weighing display.	  
9.	<p>Each time you press the MODE key, the units will switch in the specified order.</p> <p>Order from g to $\frac{1}{10}$ *.</p> <p>* In the specific gravity mode, the unit is $\frac{1}{10}$ when calculating the density.</p> <p>The display unit is g when measuring weight in air ($d - A$ shows at the top left and the "▲" mark blinks) and when measuring weight in water ($d - B$ shows at the top left, "◀" mark shows).</p>	  

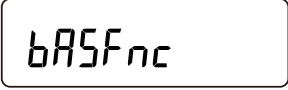
Selecting Substance (Solid or Liquid)

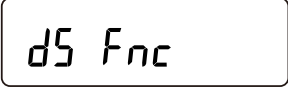
- Select a substance which is either solid or liquid. It can be specified at "substance selection ($d5$)" of "density function ($d5 Fnc$)" in the function table.

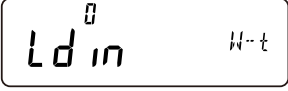

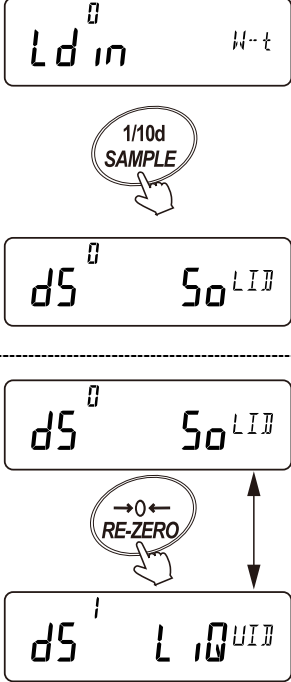
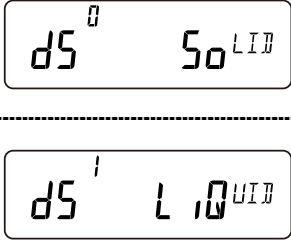





Step	Description	Display and Key Operation
10.	Press and hold (for about 2 seconds) the SAMPLE key while the scale is in weighing mode. $bASFnC$ of the function table is displayed.	 <p>1/10d SAMPLE</p> <p>Press and hold (for about 2 seconds)</p> 
11.	Press the SAMPLE key several times to display the "density function ($d5 Fnc$)".	 <p>1/10d SAMPLE</p> <p>Press several times</p> 
12.	Press the PRINT key to enter the item.	 <p>PRINT</p> 

Step	Description	Display and Key Operation
13.	<p>Select substance using the following keys.</p> <p>SAMPLE key</p> <p>Used to select "substance selection ($d5$)".</p> <p>RE-ZERO key</p> <p>Selects either "solid density measurement (\square)" or "liquid density measurement ($!$)".</p>	
14.	<p>Description of settings is as follows.</p> <p>"Solid (\square)"</p> <p>Proceeds to "7-2. Measuring Solid Density (Specific Gravity), Function Table $d5 \square$ " after step 7.</p> <p>"Liquid ($!$)"</p> <p>Proceeds to "7-4. Measuring Liquid Density (Specific Gravity), Function Table $d5 !$ " after step 7.</p>	

Selecting Input Method of Liquid Density Used for Solid Density Measurement (Specific Gravity)

- When measuring the density (specific gravity) of a liquid (function table $d5$ /), the “liquid density input (Ld_{in})” setting is irrelevant, so proceed to step 17.

Step	Description	Display and Key Operation
15.	The density of a liquid can be registered using the following keys.	
	<p>SAMPLE key</p> <p>Used to select the “Liquid density input (Ld_{in})”.</p>	
	<p>RE-ZERO key</p> <p>Specifies either “Density input of liquid using water temperature (\square)” or “Direct density input of liquid (/)”.</p>	
16.	Description of settings is as follows.	
	<p>“Water temperature input (\square)”</p> <p>Proceeds from step 7 of “7-2. Measuring Solid Density (Specific Gravity), Function Table $d5$ \square” to “Method to Input the Water Temperature (Ld_{in} \square)” of “7-3. Specifying Liquid Density”.</p>	
	<p>“Direct density input (/)”</p> <p>Proceeds from step 7 of “7-2. Measuring Solid Density (Specific Gravity), Function Table $d5$ \square” to “Method to Input the Density Directly (Ld_{in} /)” of “7-3. Specifying Liquid Density”.</p>	

Step	Description	Display and Key Operation
17.	Press the PRINT key to register the settings.	 
18.	All preparations are complete. Press the CAL key to enter the weighing mode to start measurement.	  
19.	Press the MODE key to display the specific gravity mode units. Go to “7-2. Measuring Solid Density (Specific Gravity), Function Table <i>d5 0</i> ” or “7-4. Measuring Liquid Density (Specific Gravity), Function Table <i>d5 1</i> ”.	  Measuring Solid Density (<i>d5 0</i>) or  Measuring Liquid Density (<i>d5 1</i>)

Reference

- The density function (specific gravity) uses "density function (*d5 Fnc*)" of the function table.

Class	Item	Parameter	Description
<i>d5 Fnc</i> Density function (Specific gravity)	<i>Ld in</i> Liquid density input	■ <i>0</i>	Density input of a liquid using water temperature
		<i>1</i>	Direct density input of a liquid
	<i>d5</i> Substance selection	■ <i>0</i>	Density measurement of a solid
		<i>1</i>	Density measurement of a liquid

- indicates factory settings.





7-2. Measuring Solid Density (Specific Gravity), Function Table d_5



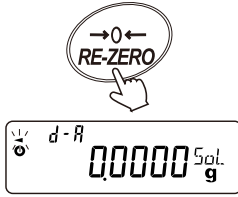
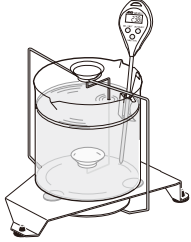
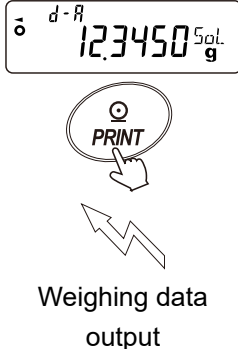
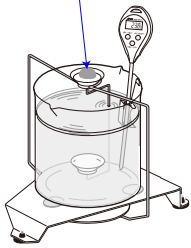
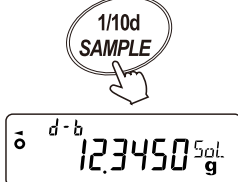

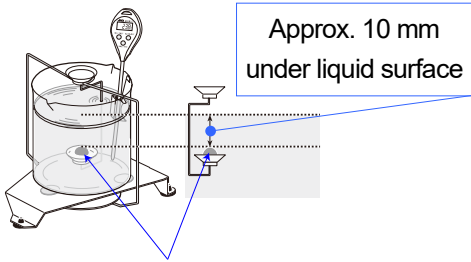
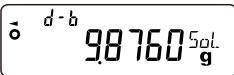
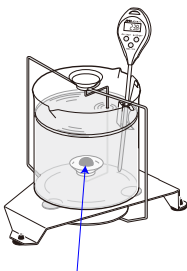
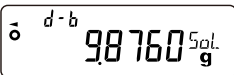



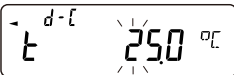

Cautions

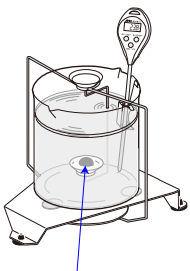
- When the temperature or type of liquid changes, register again the density of the liquid using "7-3. Specifying Liquid Density".
- The measurement value of the density function (specific gravity mode) is fixed to 4 decimal places. The minimum division cannot be changed using the **SAMPLE** key.
- The procedure of the density (specific gravity) measurement is to weigh the sample in air, to weigh the sample in liquid and to display calculated density of the sample.

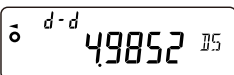
Procedure

Step	Description	Display and Key Operation	Weighing Operation
1.	<p>Weighing mode for in air</p> <p>Preparation for measurement in air.</p> <p>($d-R$ shows and RE-ZERO blinks)</p> <p>Press the RE-ZERO key to display zero with nothing is put on the upper pan and lower pan.</p>		
2.	<p>Put the sample on the upper pan and wait until the weighing value is stable. If necessary, press the PRINT key to output the weight of the sample.</p> <p>Example output: Weight in air A&D standard format (factory setting)</p> <div style="border: 1px solid black; padding: 2px; display: inline-block;">ST, +012.3450_ _g</div> <p>_ is a space</p>		<p>Sample in the air</p> 
3.	<p>Press the SAMPLE key to record the weight in air and proceed to the weighing mode for in liquid</p> <p>($d-b$ shows and \leftarrow shows).</p> <p>Cautions</p> <p>The SAMPLE key is inactive when weighing value is overload E .</p>		

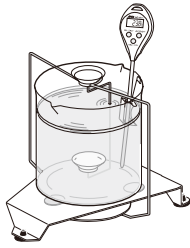
Step	Description	Display and Key Operation	Weighing Operation
4.	<p>Weighing mode for in liquid</p> <p>Move the sample from the upper pan to lower pan. ($d-b$ shows and \blacktriangleleft shows).</p> <p>Adjust the amount of the liquid so that sample is approximately 10 mm under the liquid surface when the sample is put on lower pan in the liquid.</p>  <p style="text-align: center;">Sample in the liquid</p>		 <p style="text-align: center;">Sample in the liquid</p>
5.	<p>Press the PRINT key to output the weighing value.</p> <p>Example output: Weight in air A&D standard format (factory setting)</p> <div style="border: 1px solid black; padding: 2px; display: inline-block;">ST, +009.8760_ _g</div> <p>_ is a space</p>	   <p style="text-align: center;">Weighing data output</p>	
6.	<p>Press the SAMPLE key to record the weight in the liquid and proceed to the liquid density input mode ($d-[$ shows and \blacktriangleleft shows).</p> <p>Cautions</p> <p>The SAMPLE key is inactive when weighing value is overload <div style="border: 1px solid black; padding: 2px; display: inline-block;">E</div> .</p>		

Step	Description	Display and Key Operation	Weighing Operation
7.	<p>Liquid density input mode</p> <p>Input the density of the liquid. Refer to “Method to Input the Water Temperature (L d in 0)” (page 23) or “Method to Input the Density Directly (L d in 1)” (page 24) in “7-3. Specifying Liquid Density”.</p>	 <p>Input the water temperature (L d in 0)</p> <p>or</p>  <p>Input the density directly (L d in 1)</p>	 <p>Sample in the liquid</p>
8.	<p>Press the PRINT key to proceed to the density display of a solid. ($d-d$ shows and \blacktriangleleft shows)</p>	 	
9.	<p>Solid density display mode</p> <p>If necessary, while the density of the sample is displayed, press the PRINT key to output the density. The unit of density (specific gravity) is DS.</p> <p>Example output: Density (specific gravity) A&D standard format (factory setting)</p> <div style="border: 1px solid black; padding: 2px; width: fit-content;">ST, +004.9852_DS</div> <p>$_$ is a space</p>	   <p>Weighing data output</p>	
10.	<p>If another sample is to be measured, press the SAMPLE key and proceed to step 1 of “Weighing mode for in air” ($d-R$ shows and \blacktriangleleft blinks).</p>	 	
11.	<p>When the temperature or type of a liquid being measured changes, if necessary, register again the density of the liquid according to step 7 of “Liquid density input mode”.</p>	<p>Refer to “Liquid density input mode” in step 7.</p>	
12.	<p>If the MODE key is pressed, the display is changes to another weighing mode.</p>		

7-3. Specifying Liquid Density

- Select the density input method of a liquid when the solid density is measured.

The “liquid density input (Ld_{in})” has “[Method To Input The Water Temperature \(\$Ld_{in} \text{ } \square\$ \)](#)” (page 23) and “[Method To Input The Density Directly \(\$Ld_{in} \text{ } |\$ \)](#)” (page 24).

Method To Input The Water Temperature ($Ld_{in} \text{ } \square$)

This step is an additional explanation of step 7 “[Liquid density input mode](#)” (page 22).

The current setting of water temperature is displayed. (Factory setting is 25.0 °C.)

Refer to [Table1](#) in “[5-2. Measuring The Density Of A Solid](#)” regarding the relation between temperature and density of water.

Register the water temperature using the following keys.

The setting range of temperature is 0.0 to 99.9 °C in 0.1 °C interval.

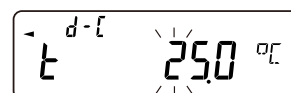

Step	Description	Display and Key Operation
1.	RE-ZERO key Increases number of blinking digit. (+ key) (Number next 9 is 0.)	
	MODE key Decreases number of blinking digit. (- key) (Number next 0 is 9.)	
	SAMPLE key Moves blinking digit.	

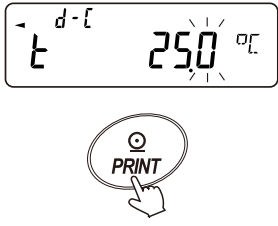
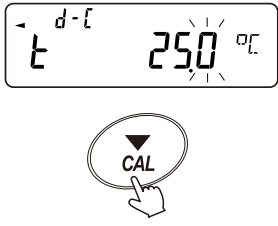
Step	Description	Display and Key Operation
1.	<p>PRINT key</p> <p>Stores the current setting and proceeds to the density display. (Go to Step 9. “Solid density display mode”) (page 22)</p>	
	<p>CAL key</p> <p>Cancels the setting and proceeds to the density display. (Go to Step 9. “Solid density display mode”) (page 22)</p>	

Method To Input The Density Directly (Liquid)

This step is an additional explanation of step 7 “Liquid density input mode” (page 22).



The current setting of density of water is displayed. (Factory setting is 1.0000 g/cm³.)

Register density of water using the following keys.

The setting range of density is 0.0000 to 1.9999 g/cm³.

If the input becomes out of range, the balance displays  and returns to the input display.

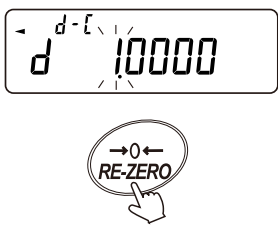



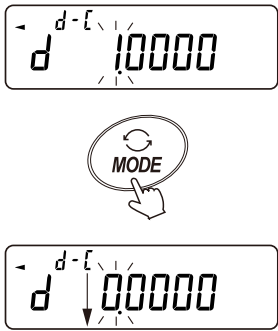
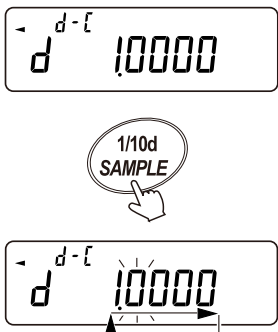
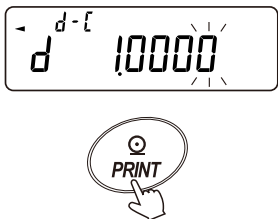
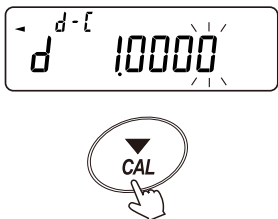



Step	Description	Display and Key Operation
1.	<p>RE-ZERO key</p> <p>Increases number of blinking digit. (+ key) (Number next 9 is 0.)</p>	 





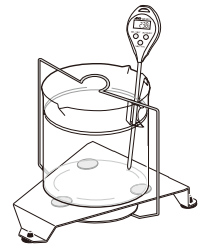

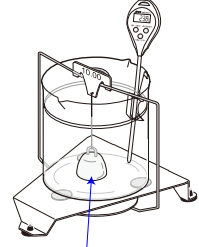
Step	Description	Display and Key Operation
1.	<p>MODE key</p> <p>Decreases number of blinking digit. (- key) (Number next 0 is 9.)</p>	 <p>The diagram shows two stages of the display. The first stage shows 'd' followed by '10000' with a vertical line above the first zero and a vertical line below the second zero. The second stage shows 'd' followed by '00000' with a vertical line above the first zero and a vertical line below the second zero. A hand icon points to a circular button labeled 'MODE' with a circular arrow icon.</p>
	<p>SAMPLE key</p> <p>Moves blinking digit.</p>	 <p>The diagram shows two stages of the display. The first stage shows 'd' followed by '10000' with a vertical line above the first zero and a vertical line below the second zero. The second stage shows 'd' followed by '10000' with a vertical line above the first zero and a horizontal line below the second zero. A hand icon points to a circular button labeled '1/10d SAMPLE' with a circular arrow icon.</p>
	<p>PRINT key</p> <p>Stores the current setting and proceeds to the density display. (Go to Step 9. “Solid density display mode”) (page 22)</p>	 <p>The diagram shows two stages of the display. The first stage shows 'd' followed by '10000' with a vertical line above the first zero and a vertical line below the second zero. The second stage shows 'd' followed by '10000' with a vertical line above the first zero and a horizontal line below the second zero. A hand icon points to a circular button labeled 'PRINT' with a circular arrow icon.</p>
	<p>CAL key</p> <p>Cancels the setting and proceeds to the density display. (Go to Step 9. “Solid density display mode”) (page 22)</p>	 <p>The diagram shows two stages of the display. The first stage shows 'd' followed by '10000' with a vertical line above the first zero and a vertical line below the second zero. The second stage shows 'd' followed by '00000' with a vertical line above the first zero and a vertical line below the second zero. A hand icon points to a circular button labeled 'CAL' with a downward arrow icon.</p>

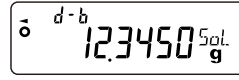

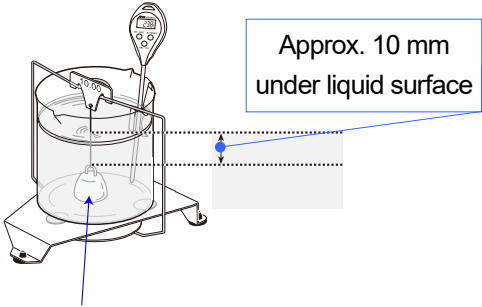
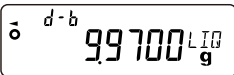
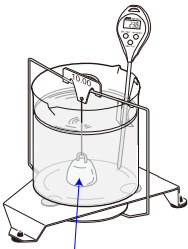
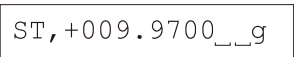
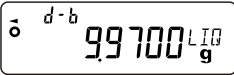

7-4. Measuring Liquid Density (Specific Gravity), Function Table $d5$ 1

- The measurement value of density (specific gravity) is fixed to 4 decimal places. Minimum division cannot be changed using the **SAMPLE** key. The procedure of the density (specific gravity) measurement is to weigh the float in air, to weigh the float in liquid and to display calculated density of the float. Each status and indications are as follows :

Procedure

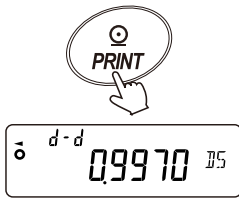
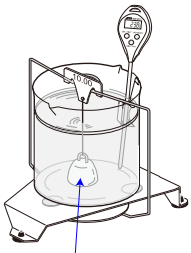
Step	Description	Display and Key Operation	Weighing Operation
1.	<p>Weighing mode for in air</p> <p>Preparation for a measurement in air. ($d-R$ shows ,  blinks)</p> <p>Press the RE-ZERO key to display zero with nothing placed on the density pan stand.</p>	 	
2.	<p>Put the float on the upper pan and wait until the weighing value is stable. If necessary, press the PRINT key to output the weight of the sample..</p> <p>Example output: Weight in air A&D standard format (factory setting)</p> <div style="border: 1px solid black; padding: 2px; display: inline-block;">ST, +019.9400_ _g</div> <p>_ is a space</p>	  <p>Weighing data output</p>	 <p>Float in the air</p>
3.	<p>Press the SAMPLE key to record weight in air and proceed to the weighing mode for liquid</p> <p>($d-b$ shows and \blacktriangleleft shows).</p> <p>Cautions</p> <p>The SAMPLE key is inactive when weighing value is overload E .</p>	 	

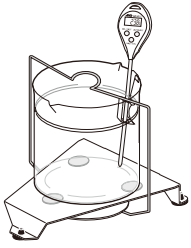
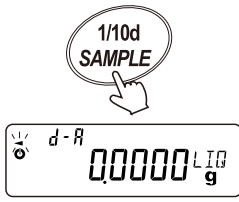
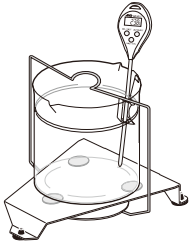
Step	Description	Display and Key Operation	Weighing Operation
4.	<p>Weighing mode for in liquid</p> <p>To measure the density of the liquid, pour it into the beaker and sink the float. ($d-b$ shows, \blacktriangleleft shows).</p> <p>Adjust the amount of the liquid so that the float is approximately 10 mm under the liquid surface when float is hung in the liquid.</p>  <p>Float in the liquid</p>		 <p>Float in the liquid</p>
5.	<p>Wait until the weighing value is stable. To output the weighing value, press the PRINT key.</p> <p>Example output: Weight in liquid A&D standard format (factory setting)</p>  <p>_ is a space</p>	   <p>Weighing data output</p>	
6.	<p>Press the SAMPLE key to record the weight in the liquid and proceed to the float volume input mode ($d-[]$ shows and \blacktriangleleft shows).</p> <p>Cautions</p> <p>The SAMPLE key is inactive when weighing value is overload  .</p>	  <p>Volume input mode</p>	
7.	<p>Float volume input mode</p> <p>Input the volume of the float. Refer to “7-5. Specifying Volume of Float” and input the volume of the float.</p>	<p>Refer to “7-5. Specifying Volume of Float”.</p>	

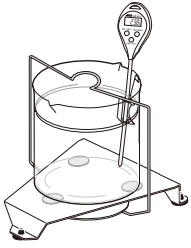
Step	Description	Display and Key Operation	Weighing Operation
8.	Press the PRINT key to proceed to the density display ($d-d$ shows and \blacktriangleleft shows).		 <p data-bbox="1189 519 1380 548">Float in the liquid</p>
9.	<p>Liquid density display mode</p> <p>If necessary, while the calculated density of the liquid is displayed, press the PRINT key to output the density.</p> <p>The unit of density (specific gravity) is DS.</p> <p>Example output: density (specific gravity) A&D standard format (factory setting)</p> <div data-bbox="228 920 523 976" style="border: 1px solid black; padding: 2px; width: fit-content;">ST, +000.9970_DS</div> <p>_ is a space</p>	  <p data-bbox="938 833 1117 907">Weighing data output</p>	
10.	If another sample is to be measured, press the SAMPLE key and proceed to step 1 of "Weighing mode for in air" ($d-R$ shows and \blacktriangleleft blinks).		
11.	If the MODE key is pressed, the display is changes to another weighing mode.		

7-5. Specifying Volume of Float

This step is an additional explanation of step 7 “[Float volume input mode](#)” (page 27).

The current volume of the float is displayed. (Factory setting is 10.00 cm³.)

Register the volume using the following keys.

The setting range of volume is 0.01 to 99.99 cm³ in 0.01 cm³ interval.

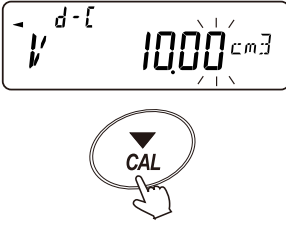

Step	Description	Display and Key Operation
1.	<p>RE-ZERO key</p> <p>Increases number of a blinking digit. (+ key) (Number next 9 is 0.)</p>	
	<p>MODE key</p> <p>Decreases number of a blinking digit. (- key) (Number next 0 is 9.)</p>	
	<p>SAMPLE key</p> <p>Moves a blinking digit.</p>	
	<p>PRINT key</p> <p>Stores the current setting and proceeds to the density display. (Go to Step 9. “Liquid density display mode”) (page 28.)</p>	

Step	Description	Display and Key Operation
1.	<p>CAL key</p> <p> Cancels the setting and proceeds to the density display. (Go to Step 9. “Liquid density display mode”) (page 28.)</p>	 <p>The diagram shows a digital display with the text 'V d- [1000 cm³]'. Below the display is a circular button labeled 'CAL' with a downward-pointing triangle above it. A hand icon is shown pressing the 'CAL' button.</p>

8. Frequently Asked Questions

Questions	Answers
I'd like to measure the density of a resin pellet or sheet, which floats in water. Is it possible?	Use a liquid that has a lower density than water and does not dissolve the sample, such as methanol (density 0.798) or kerosene (density 0.80). The density of the liquid used is measured using the float provided with the kit.
Can a sample containing bubbles be measured?	The density of a sample with bubbles can be measured as it is. But as time passes, the bubbles disappear and the apparent density may change. A sample that floats in water due to the low density can not be measured.
The measurement repeatability may be affected by the water's surface tension. What can I do about this?	A few drops of a surfactant (for example, a mild detergent for washing dishes) added to the water reduce the influence of surface tension. A few drops of a surfactant will affect the liquid density only a very small amount. When methanol is used in place of water, the influence of surface tension is small, even without a surfactant.
When tap water is used, bubbles are gradually generated on the sample surface and a measurement error occurs. What can I do about this?	Tap water contains dissolved gases such as oxygen and carbon dioxide. When tap water is used, the released dissolved gases generate bubbles. It is recommended that pure water or distilled water, which contains few dissolved gases, be used.
When I try to measure a highly water-repellent material such as rubber, bubbles stick to the sample. What can I do about this?	Before measurement, soak the sample in the water with an appropriate amount of surfactant added. Doing this increases the sample surface hydrophilicity and makes it more difficult for bubbles to stick to the sample surface.
Up to what size of sample can be measured?	In consideration of the density pan size, the maximum sample size that can be measured is: Diameter □25 mm, Height 30 mm,
Can I measure the density of a liquid with a high viscosity?	A liquid with a viscosity up to 500 mPa·s can be measured. If the viscosity exceeds this value, the float takes excessive time to sink and a measurement error occurs. Measuring adhesive is not recommended because the adhesive sample may be difficult to remove from the float.
Does using a semi-micro balance improve accuracy?	The effects of surface tension cause errors in the measurement value of around 0.2 to 1.0 mg. In measurement using the 0.1 mg range, the magnitude of error and the level of balance accuracy are almost the same. In measurement using the 0.01 mg range, the magnitude of error greatly exceeds the level of balance accuracy, so using a semi-micro balance is not recommended.

9. Water Resistant Digital Thermometer AD-5625

9-1. For Safe Use

Please take the following precautions when operating this device.

- Repair

Opening the case to attempt repair of the device should not be done by anyone other than designated repair staff. Doing so will not only void the warranty, but also may result in mechanical error or loss of functionality.

- Error in the device

When an error has been found in the device, stop using it immediately and attach a label indicating the device is "Faulty" or store it in a location where it will not be used inadvertently. Continuing to use the device without proper repair could be highly dangerous. Please contact A&D or the authorized dealer in your area for advice on repair of the device.

9-2. Precautions When Handling

- After using the device for measuring very high (50°C or higher) or low (0°C or lower) temperatures, the probe should not be handled until it has returned to a normal temperature range. Doing so may result in burning or other damage to skin.

- The sheath (metal part) of the probe can be used for temperatures up to 260°C, but the plastic display section should only be used in temperatures up to 60°C. Please ensure the display section is not exposed to temperatures exceeding this. Doing so may result in mechanical error or deformation.

- Please note that the end of the sheath is sharp, so may cause harm to people or objects. When being carried or not in use, please keep in the sheath holder.

- Please ensure the device is not subject to severe impacts, vibrations or electric shocks. This may result in mechanical error.

- Do not use the device in direct sunlight for a prolonged period of time, in an unventilated vehicle or close to a heat source. The operating temperature range for the device is 0 to 40°C. Use outside this temperature range may lead to mechanical error.

- Do not use the device in an area which may be subject to sudden rises in temperature, high levels of humidity or a lot of dust.

- The device has a waterproof design, however it is best not to place it in water or leave it for a long time in an area where it may become wet.

- The waterproof performance of the device conforms to protection level 7 of JIS C 0920 and can be submerged in still water at a depth of up to 1 meter for 30 minutes.

- If the battery is nearly consumed, there may be difficulties operating the device properly or obtaining a value on the display. In this case, please exchange the battery with a new one following the procedure detailed in "8-4. Replacing The Battery".

- Using the device in a location with a strong magnetic or electric field (near a television, IH cooker, microwave oven, etc.), may impact on its performance. Please try to avoid measurement in such locations.

- To prevent hazard, please do not use the device in a location near flammable gas.

9-3. Each Part Name

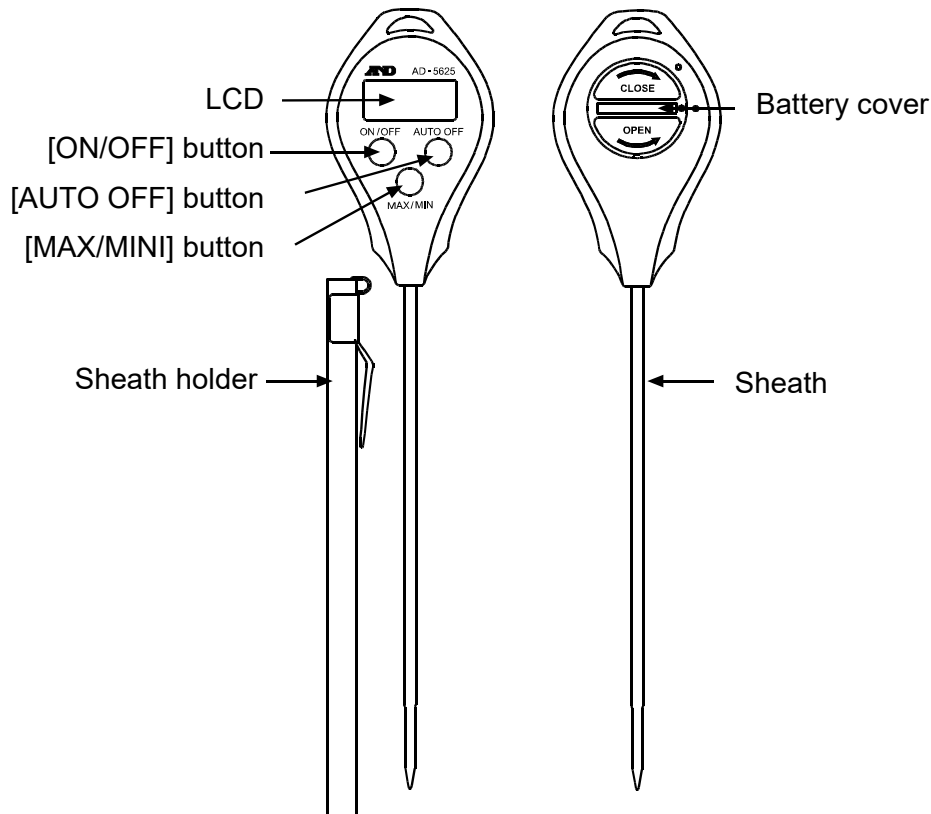

Material: Main body, battery cover: ABS

Button: Rubber

Display: PC

Sheath: SUS304

Sheath holder: PC

Sheath holder fitting: Iron (Nickel plating)

Display

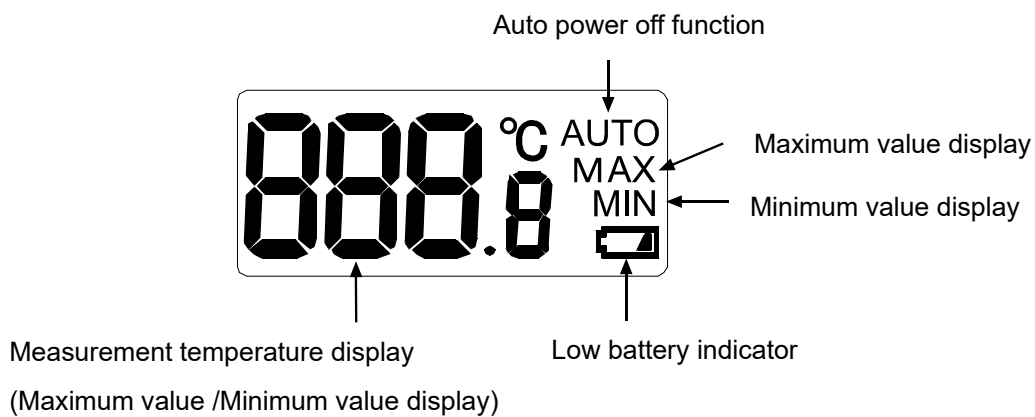

Error display

lo	Appears when the measurement temperature is below the lower limit for the display range, or there is an error in the temperature sensor or internal circuit.
Hi	Appears when the measurement temperature exceeds the upper limit for the display range, or there is an error in the temperature sensor or internal circuit.

9-4. Replacing The Battery

The battery has not been installed in the device when purchasing this device. Properly install the battery in the device by the following procedure.

Also, when the “” appears at the bottom right on the display, replace the old battery with new one by the following procedure.

- * Purchase the battery at your local convenience store, supermarket, home center or electrical store.
- * When the main body is damp, wipe the moisture fully and exchange the battery.

The device may be damaged if water gets inside.

Replacing the battery

- (1) Turn the battery cover on the rear side of the main body in counter clockwise direction by using a coin, and remove the battery cover from the device.
- (2) Remove the old battery from the device.
- (3) Put a new CR2032 coin type lithium battery with the + side of the battery facing outward in the device.
- (4) Put the battery cover back on the device.

As shown in the figure below, put the battery cover so that the upper mark on the main body and the mark on the battery cover join together, and turn the battery cover in clockwise direction using a coin until the mark on the battery cover joins the lower mark on the main body.

The battery cover not secured properly may result in water entering and damaging the device.

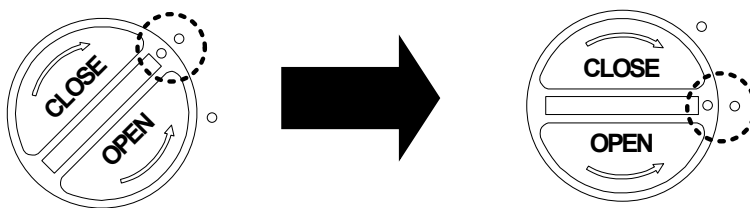

 CAUTION

Precautions on the battery use

- The provided battery is for monitoring purpose, and its life may therefore be shorter than the battery life specified in this manual.
- Remove the battery from the device and keep it elsewhere when you are not using the device for a long period of time,
- Be sure the specified battery (CR2032 coin type lithium battery 1pc) is used.
- Mind the direction for polarity. Reverse polarity may not only cause operation errors but also damage the device.
- The battery should not be recharged, short-circuited, disassembled, or thrown into the fire, Such action may cause a burst or leak of liquid of the battery.
- Keep the battery out of children's reach. Talk to a doctor immediately in case a child swallowed the battery.
- For environmental protection, dispose of a spent battery by following your local regulations.

9-5. Operating the Thermometer

Measuring the temperature

- (1) Press the [ON/OFF] button to turn the power on.
- (2) Remove the sheath holder when it is attached to the sheath.
- (3) Measure the temperature by one of the following methods depending on the material to be measured.

When measuring the liquid

Immerse the sensor into the position where you would like to measure the temperature.

When there is steam arising from the liquid, handle the device so that the display is not exposed to the steam. Otherwise the steam may damage the device.



When measuring the semisolid material

Stick the sensor to the depth where you would like to measure the temperature in the material.

Attempting to forcibly stick the sensor into the material when the measurement material is too solid may damage the sheath. In such case, a device that enables smooth insertion of the sensor is required.

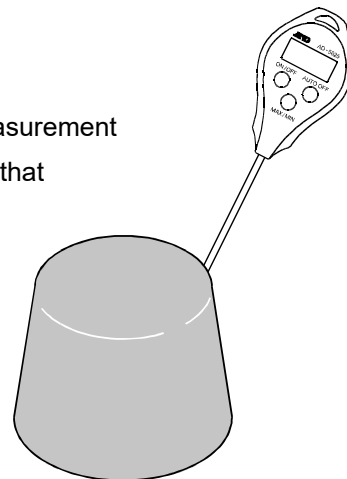

When measuring the gas

Place the sensor in the location where you would like to measure the temperature and wait **until** the display becomes stable.

When measuring a high temperature atmosphere such as steam, use a shield to protect the display from high temperature.

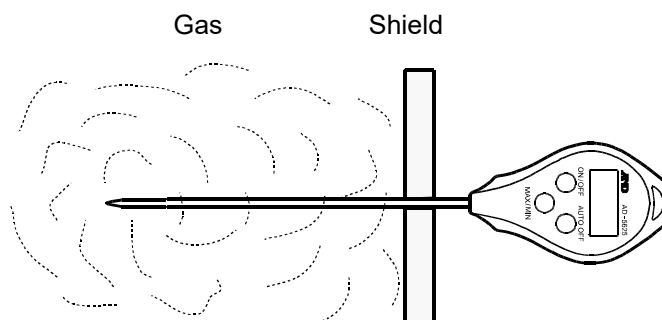

⚠ CAUTION

The device detects a temperature at the tip of the sheath.

To protect the device from damage, handle the device so that the part other than the sheath is not exposed to high or low temperature of the substance to be measured.

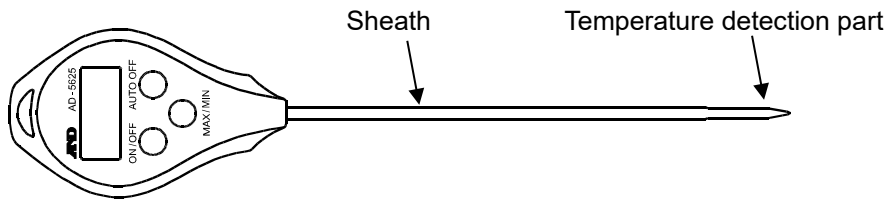

Using the maximum and minimum temperature memory

The device can automatically store the maximum and minimum temperature measured after the battery was installed in the device (Or for after the memory was reset).

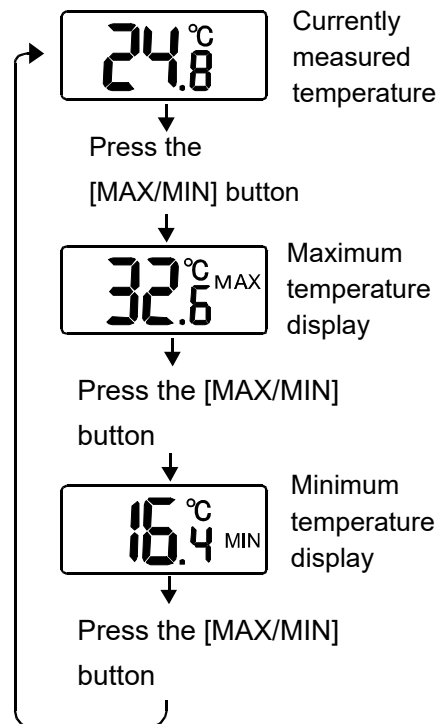

The device automatically displays the current measurement temperature if no operation is made for 30 seconds while on the maximum or minimum temperature display

To check the maximum and minimum temperatures for a new measurement, reset the memory before starting the measurement by following the “Resetting the maximum and minimum temperature memory” described below.

⚠ CAUTION

The maximum and minimum temperatures memorized in the device are reset automatically when the battery was removed from the device.

Resetting the maximum and minimum temperature memory

Reset the maximum and minimum temperature memory as follows:

Press the [MAX/MIN] button to display the maximum or minimum temperature. Press the [MAX/MIN] button again and hold it for more than two seconds. The display goes into the bar display, and the stored the maximum and minimum temperatures are reset to store new maximum and minimum temperatures.

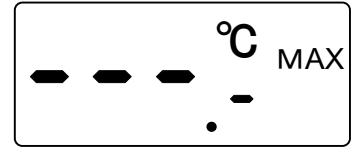

About the auto power off function and turning the power off

(1) Auto power off function

The device has the auto power off function.

The auto power off function is disabled when the battery has been replaced.

To enable the auto power off function, press the [AUTO OFF] button one time. The “AUTO” appears at the upper right on the display to show that auto power off function is now enables. With the auto power off function, the device automatically turns the power off when no operation is made for about five minutes. To disable the auto power off function, press the [AUTO OFF] button again.

The “AUTO” at the upper right on the display disappears, and the auto power off function becomes disabled.

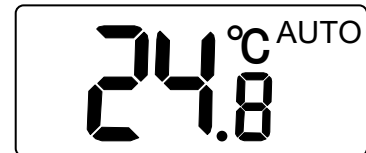

(2) Turning the power off

Press the [ON/OFF] button when you would like to turn the power off immediately.

How to use the sheath holder

Use the sheath holder to protect the sheath when you carry the device.

Be sure the sheath holder is removed from sheath when performing measurements.

In order to prevent the sheath holder from bring deformed or damaged, let the sheath return to the room temperature before putting the sheath holder on after performing high or low temperature measurements.

9-6. Daily Care

Accurate measurements can not be made if the temperature detection part is dirty. It should be kept clean when performing measurements.

Avoid rubbing it when the main body is dirty. Instead, rinse the dirt off using water.

When the dirt is heavy, wipe it off gently using a kitchen sponge, etc., dampened with ph-neutral detergent.

Do not use abrasives or volatile solvents such as thinner or benzine, etc.

9-7. Specifications

Sensor	: Thermistor
Temperature measurement range	: -40.0°C to +260.0°C
Display resolution	: 0.1°C
Measurement accuracy	: ±1.0°C (-9.9 to 59.9°C) ±2.0°C(-19.9 to -10.0°C, 60.0 to 99.9°C) ±3.0°C(-29.9 to -20.0°C, 100.0 to 199.9°C) ±4.0°C(-40.0 to -30.0°C, 200.0 to 260.0°C)
Display refreshment interval	: Every one second
Waterproof level	: JIS IPX7 (Waterproof for 30 minutes at a water depth of 1 meter, still water at room temperature)
Power supply	: CR2032 x 1 pc
Battery life	: Approx.1 year (When used for one hour per day)
Operating temperature and humidity	: 0 to 40°C, 75%RH or less (No condensation) (Excluding the sheath)
Storage temperature and humidity	: 0 to 50°C, 75%RH or less (No condensation)
External dimension of the sheath	: Φ2.8mm (The tip is Φ2.2mm, the length is 20 mm),Approx. 120mm
External dimension	: 40(W) x 187(H) x 17(D) mm (The protrusion is not included.)
Weight	: Approx. 27g (The battery and sheath holder is included.)
Standard accessory	: Instruction manual, sheath holder, battery (For monitor battery)



A&D Company, Limited

3-23-14 Higashi-Ikebukuro, Toshima-ku, Tokyo 170-0013, JAPAN
Telephone: [81] (3) 5391-6132 Fax: [81] (3) 5391-1566

A&D ENGINEERING, INC.

47747 Warm Springs Blvd, Fremont, California 94539, U.S.A.
Tel: [1] (800) 726-3364 Weighing Support:[1] (888) 726-5931 Inspection Support:[1] (855) 332-8815

A&D INSTRUMENTS LIMITED

Unit 24/26 Blacklands Way, Abingdon Business Park, Abingdon, Oxfordshire OX14 1DY United Kingdom
Telephone: [44] (1235) 550420 Fax: [44] (1235) 550485

A&D AUSTRALASIA PTY LTD

32 Dew Street, Thebarton, South Australia 5031, AUSTRALIA
Telephone: [61] (8) 8301-8100 Fax: [61] (8) 8352-7409

A&D KOREA Limited

한국에이.엔.디(주)
서울특별시 영등포구 국제금융로6길33 (여의도동) 맨하탄빌딩 817 우편 번호 07331
(817, Manhattan Bldg., 33. Gukjegeumyung-ro 6-gil, Yeongdeungpo-gu, Seoul, 07331 Korea)
전화: [82] (2) 780-4101 팩스: [82] (2) 782-4264

OOO A&D RUS

ООО "ЭЙ энд ДИ РУС"

Почтовый адрес:121357, Российская Федерация, г.Москва, ул. Вереysкая, дом 17
Юридический адрес: 117545, Российская Федерация, г. Москва, ул. Дорожная, д.3, корп.6, комн. 86
(121357, Russian Federation, Moscow, Vereyskaya Street 17)
тел.: [7] (495) 937-33-44 факс: [7] (495) 937-55-66

A&D Instruments India Private Limited

ऐ&डी इन्स्ट्रुमेंट्स इण्डिया प्रा० लिमिटेड

509, उद्योग विहार , फेस -5, गुडगांव - 122016, हरियाणा , भारत
(509, Udyog Vihar, Phase-V, Gurgaon - 122016, Haryana, India)
फोन : [91] (124) 4715555 फैक्स : [91] (124) 4715599

A&D SCIENTECH TAIWAN LIMITED. A&D台灣分公司 艾安得股份有限公司

台灣台北市中正區青島東路5號4樓
(4F No.5 Ching Tao East Road, Taipei Taiwan R.O.C.)
Tel : [886](02) 2322-4722 Fax : [886](02) 2392-1794

A&D INSTRUMENTS (THAILAND) LIMITED

บริษัท เอ แอนด์ ดี อินสตรูमेंท์ (ไทยแลนด์) จำกัด
168/16 หมู่ที่ 1 ตำบลรังสิต อำเภอธัญบุรี จังหวัดปทุมธานี 12110 ประเทศไทย
(168/16 Moo 1, Rangsit, Thanyaburi, Pathumthani 12110 Thailand)
Tel : [66] 20038911