

AD-4408A

**Weighing Indicator
for Modbus-RTU Interface**

AX-ABCC-MODBUS





INSTRUCTION MANUAL



1WMPD4001975

WARNING DEFINITIONS

The warnings described in this manual have the following meanings:

 WARNING	A potentially hazardous situation which, if not avoided, could result in death or serious injury.
 CAUTION	A potentially hazardous situation which, if not avoided, may result in minor or moderate injury or damage to the instrument.
	This symbol indicates caution against electrical shock. Do not touch the part where the symbol is placed.
	This symbol indicates the ground terminal.
	This symbol indicates that an operation is prohibited.
NOTE	Information or cautions to use the device correctly.

© 2009 A&D Company, Limited. All rights reserved.

No part of this publication may be reproduced, transmitted, transcribed, or translated into any language in any form by any means without the written permission of A&D Company, Limited.

The contents of this manual and the specifications of the instrument covered by this manual are subject to change for improvement without notice.

Modbus is a registered trademark of Modicon, Incorporated.

Anybus-CompactCom is a registered trademark of HMS Industrial Networks.

TORX is a registered trademark of Textron Inc.



Contents

1.	Introduction	2
2.	Description of Each Part	3
2.1.	Status LEDs	3
2.2.	Communication Connector	4
3.	Installation	5
3.1.	Interface Module Installation	5
3.2.	Connections and Functions	6
3.2.1.	Cable Connections	6
3.2.2.	Setting the Functions	7
4.	Modbus Memory	9
4.1.	Memory Map	9
4.2.	Handling Bits Directly	13
4.2.1.	Handling Command Bits	13
4.2.2.	Command bit execution procedure	13
5.	Timing Chart	14
6.	Errors	15
6.1.	Error Types	15
7.	Check Mode	16
7.1.	Checking the Modbus-RTU Communication Status	16
7.1.1.	Entering the Check Mode	16



1. Introduction

- The AD-4408A functions as a slave device of Modbus (RTU) when the Modbus-RTU interface module (AX-ABCC-MODBUS) is installed.
- A signal level can be selected either for RS-232 or RS-485.
- Data communication using Modbus can be performed by pre-mapped memory operation. Thus, programming communication protocol is not required.

NOTE: Memory map and check modes vary with the interface module installed. This manual describes performances when the Modbus-RTU interface module is installed.

When other modules are installed, refer to the relevant instruction manual. Instruction manuals for each interface module are available on our website.



2. Description of Each Part

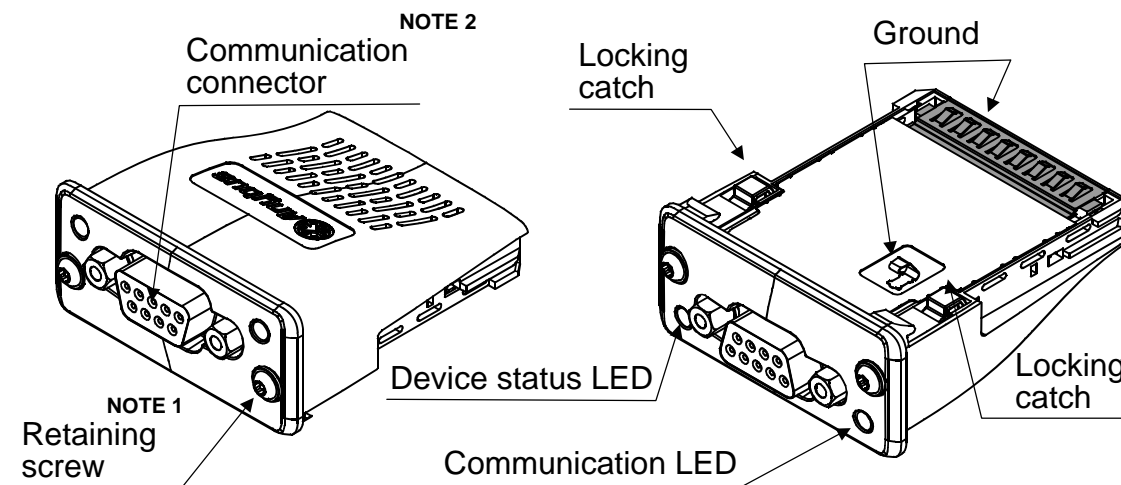

Fig.1 Interface module part names

NOTE: 1. A TORX® driver (size T9) to fasten the retaining screws is not provided with the interface module.

2. A connector for the cable side (D-Sub 9-pin male) is not provided with the interface module.

2.1. Status LEDs

NOTE: The illustration below shows how the interface module is positioned when installed to the AD-4408A.

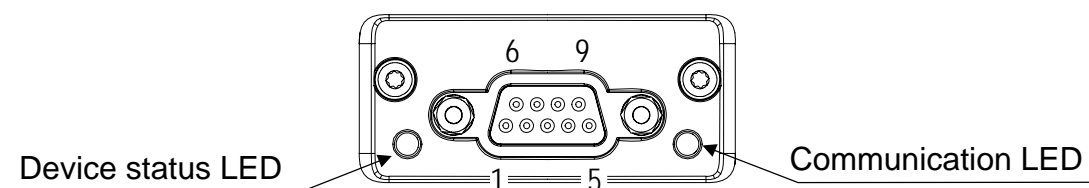

Fig.2 Position of status LEDs

Table 1 Device status LED (DS)

LED state	Description
OFF	Initializing / No power
Green ON	Normal
Red ON	Hardware malfunction
Red, single flash	Communication error / Setting error
Red, double flash	Recoverable error

Table 2 Communication LED (COM)

LED state	Description
OFF	Offline / No power
Yellow ON	Online (Normal)
Red ON	Communication error

2.2. Communication Connector

NOTE: The illustration below shows how the interface module is positioned when installed to the AD-4408A.

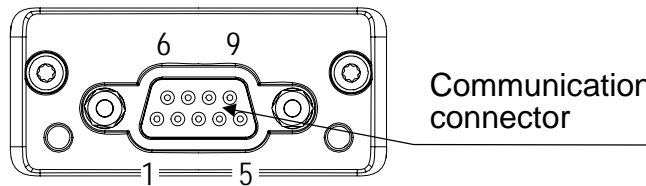

Fig.3 Connector pin assignment

Functions for each pin are as follows.

Table 3 Communication connector

Pin No.	Signal	Description
Housing	SHIELD	Shield (Connected to the AD-4408A FG terminal)
1	SG	Signal ground
2	5V	Not used
3	PMC	Selects the signal level. RS-232: Connect to pin 2. RS-485: Leave pin 3 disconnected
4	—	—
5	B (+)	RS-485 B line (Positive side)
6	—	—
7	RX	RS-232 RxD
8	TX	RS-232 TxD
9	A (-)	RS-485 A line (Negative side)

By pin connections, a signal level can be selected either for RS-232 or RS-485.



3. Installation

3.1. Interface Module Installation

⚠ CAUTION

Be sure to disconnect the AD-4408A from the power source before installing the interface module.

Install the interface module as follows:

Step 1 Using a Phillips screwdriver, loosen the screws that secure the blank panel to the AD-4408A rear panel, and remove the blank panel.

Step 2 Insert the interface module into the option slot as shown to the right.

Step 3 Insert the interface module until it mates with the terminals of the PC board connector located in the option slot.

Step 4 Using a TORX[®] driver (size T9), fasten the retaining screws with a tightening torque of 0.25 Nm in the clockwise direction to secure the interface module.

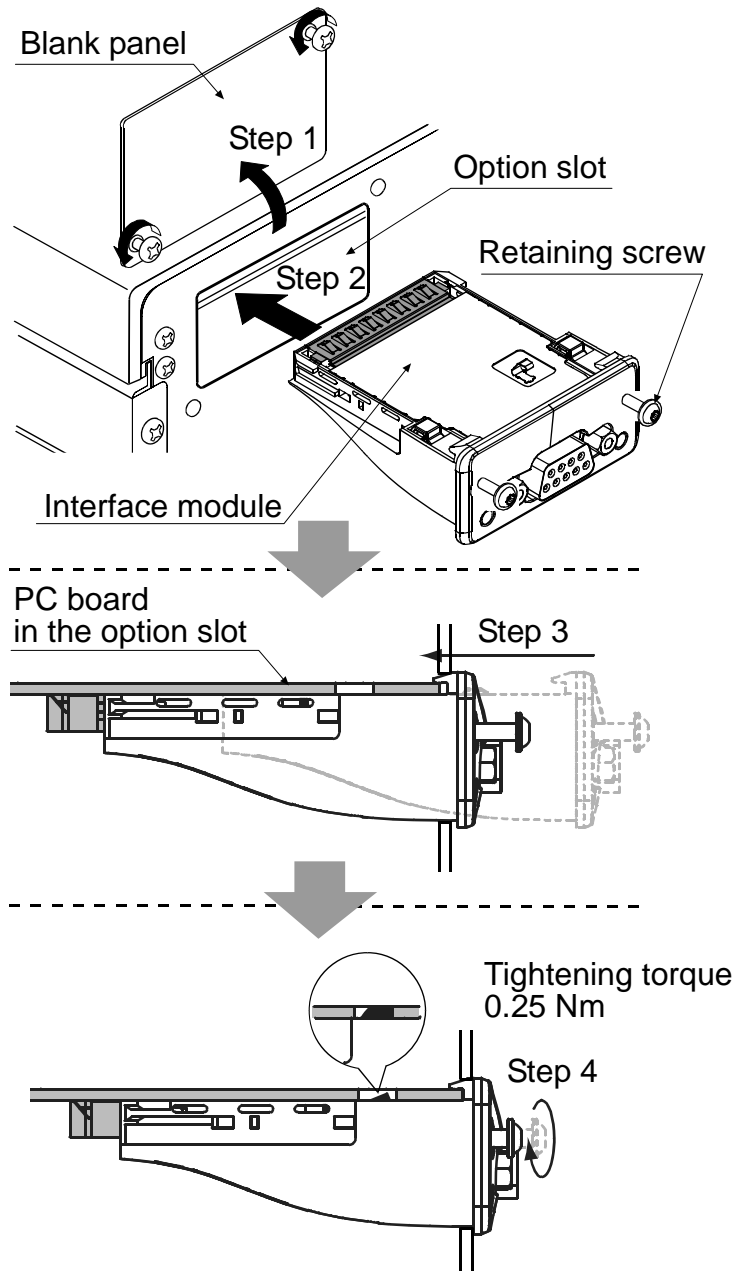

Fig.4 Interface module installation

NOTE: A TORX[®] driver is not provided with the interface module.

3.2 . Connections and Functions

3.2.1. Cable Connections

- By connector pin connections, a signal level can be selected either for RS-232 or RS-485.
- When the signal level is RS-485, add a terminator to both ends of the network. Place a terminator between A and B as shown in the figure below.
- The A-B terminals of the host device may be reversed, depending on the device type.
- When the host device has no SG terminal, an SG connection is not necessary.
- When the cable is to be shielded, connect the cable shield to the connector housing.

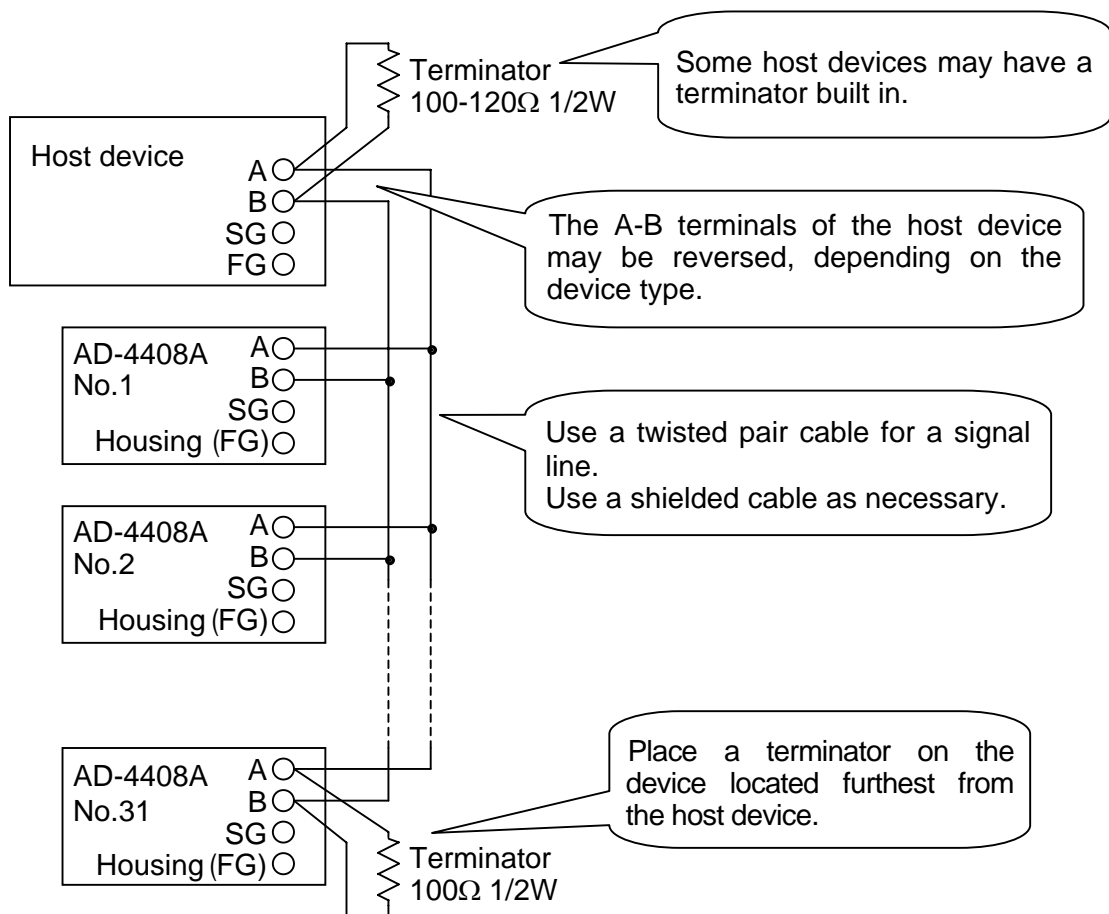

Fig.5 Example of RS-485 multidrop connection

3.2.2. Setting the Functions

The functions described here are general functions.

General functions are divided into groups per function and are indicated by the group name followed with the function number, FXX.

NOTE: General functions determine the AD-4408A performance and all of the settings are stored in the FRAM.

Setting Procedure

Step 1 While pressing and holding the ENTER key, press the F key.

Fnc is displayed to indicate that the indicator will enter the general function mode.

Step 2 Press the ENTER key. The indicator enters the general function mode.

To go back to the weighing mode without entering the general function mode, press the ESC key.

Step 3 Press the or key to select the function group to be set.

Display	Group name
r t u F	Modbus-related functions

Press the ENTER key. The function number will be displayed.







Function No.	Function	Description	Default value
r t u F 0 1	Station No.	1 to 247: Station No.	1
r t u F 0 2	Baud rate	1: 1200 bps 2: 2400 bps 3: 4800 bps 4: 9600 bps 5: 19200 bps 6: 38400 bps 7: 57600 bps 8: 76800 bps 9: 115200 bps	5
r t u F 0 3	Parity	0: None 1: Odd 2: Even	2

NOTE: Data bits are fixed to 8 bits and stop bit is fixed to 1 bit.

Step 4 Press the or key to select the function number to be set.

Press the ENTER key. The current setting value will be displayed.

Step 5 Change the setting value using either one of the methods below.

Method	Description
Selecting a parameter	Only the parameter number to be selected is displayed and blinks. Press the  or  key to select a parameter.
Inputting the value	All the digits are displayed and a digit to be changed blinks. Press the  or  key to select a digit and press the  or  key to change the value.

After setting, press the ENTER key. The next function number is displayed.

When the parameter is not to be changed, press the ESC key to return to the function number display.

Step 6 Press the ESC key. The function number disappears and the indicator returns to the state of step 3.

Press the ESC key to store the setting values in the FRAM and go back to the weighing mode.

NOTE: The blinking decimal point indicates that the current value is not the weight value.

If a value exceeding the settable range is entered, Err dt is displayed and the input is canceled.



4. Modbus Memory

4.1. Memory Map

Modbus uses reference numbers and addresses to control the AD-4408A or to read data. The AD-4408A uses Holding Registers and Input Registers.

Data types and reference numbers are as shown below.

Table 4 Data types

Data type	Reference No.	Description
Output Coil	0	Read and write bit data Corresponds to the input of the control I/O. Not used for the AD-4408A.
Input Status	1	Read only bit data Corresponds to the output of the control I/O. Not used for the AD-4408A.
Input Register	3	Read only Word data Used to read weight values and command responses.
Holding Register	4	Read and write Word data Used to send commands.

NOTE: Do not access the memory area that the AD-4408A is not using.

Table 5 Holding Register memory map

Holding Register (Read and write Word data Reference No. 4)

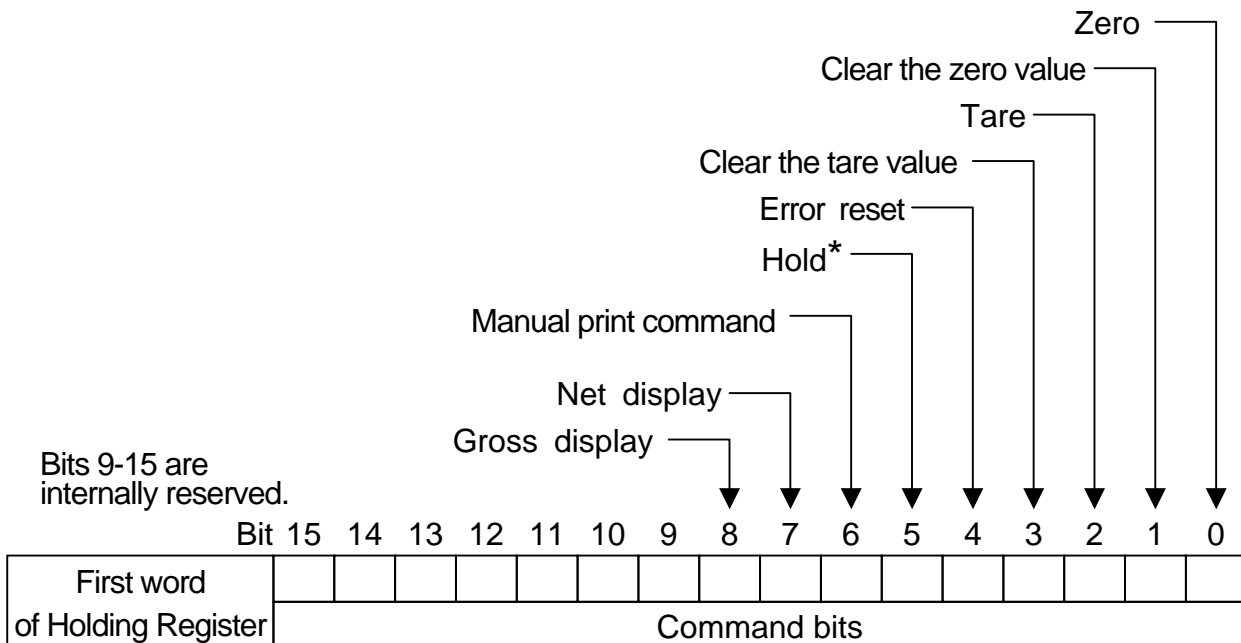

*Hold at the rising edge, release at the falling edge

Table 6 Input Register memory map

Input Register (Read only Word data Reference No. 3)

First word of Input Register	Bit 15 14 13 12 11 10 9 8 7 6 5 4 3 2 1 0	Unit	Decimal point position
	Setting value		Setting value

Unit	Decimal point position
0: None	0: None 123456
1: g	1: 10 ¹ 12345.6
2: kg	2: 10 ² 1234.56
3: t	3: 10 ³ 123.456
4: lb (USA version)	4: 10 ⁴ 12.3456
	5: 10 ⁵ 1.23456

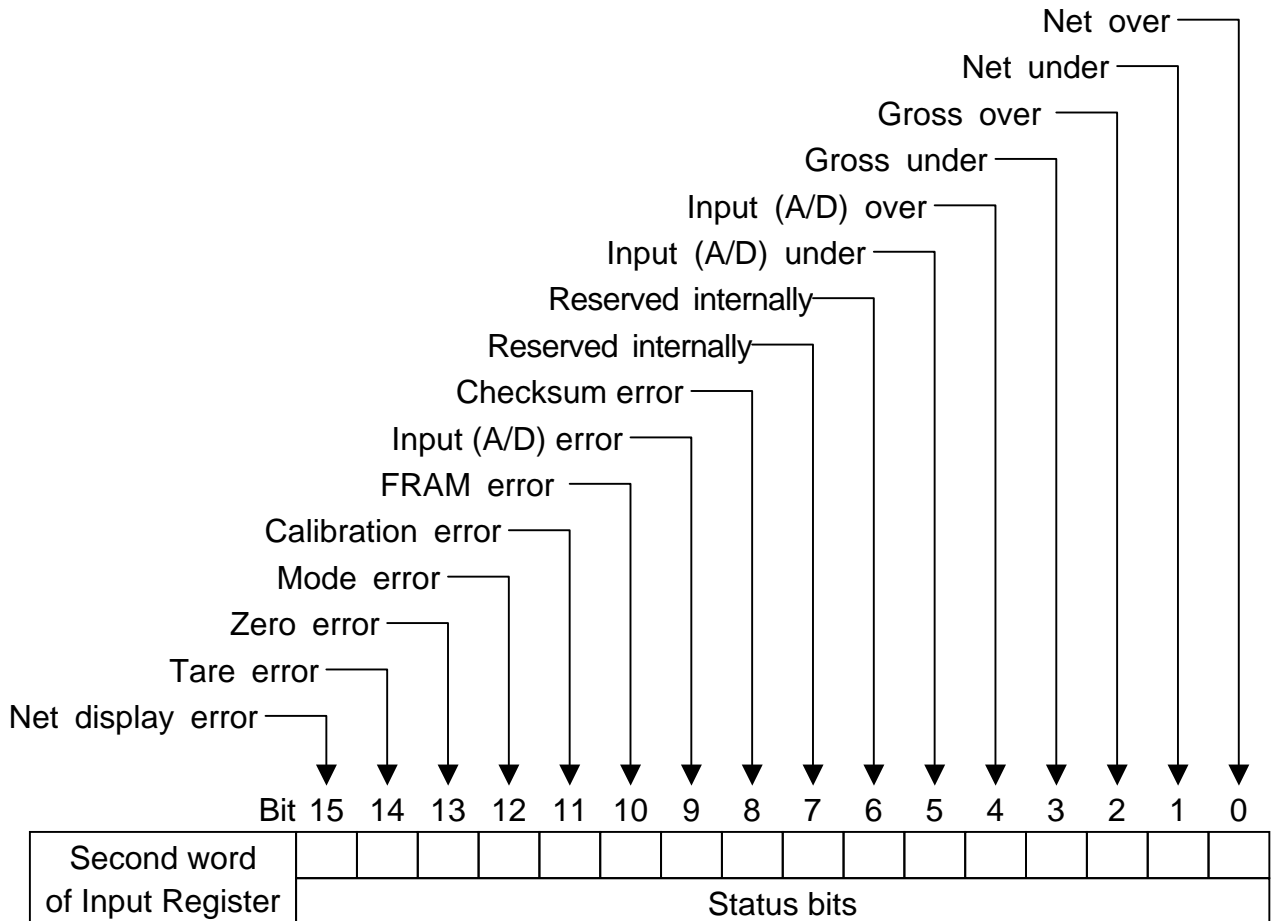

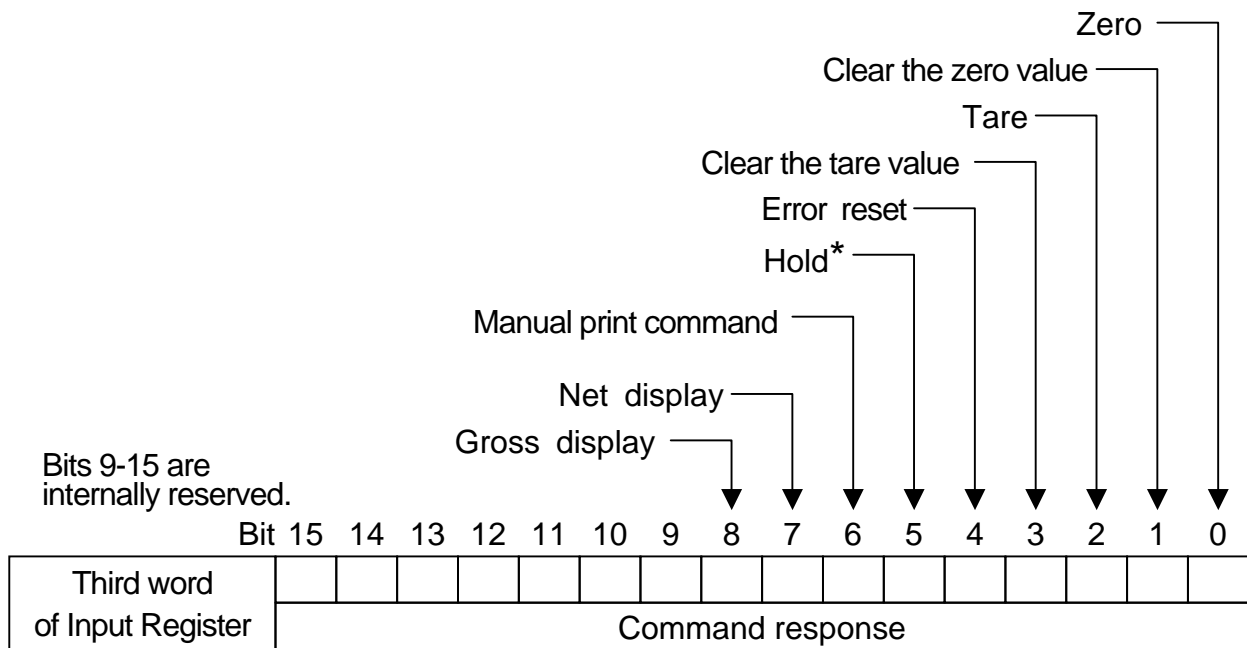

*Hold at the rising edge, release at the falling edge

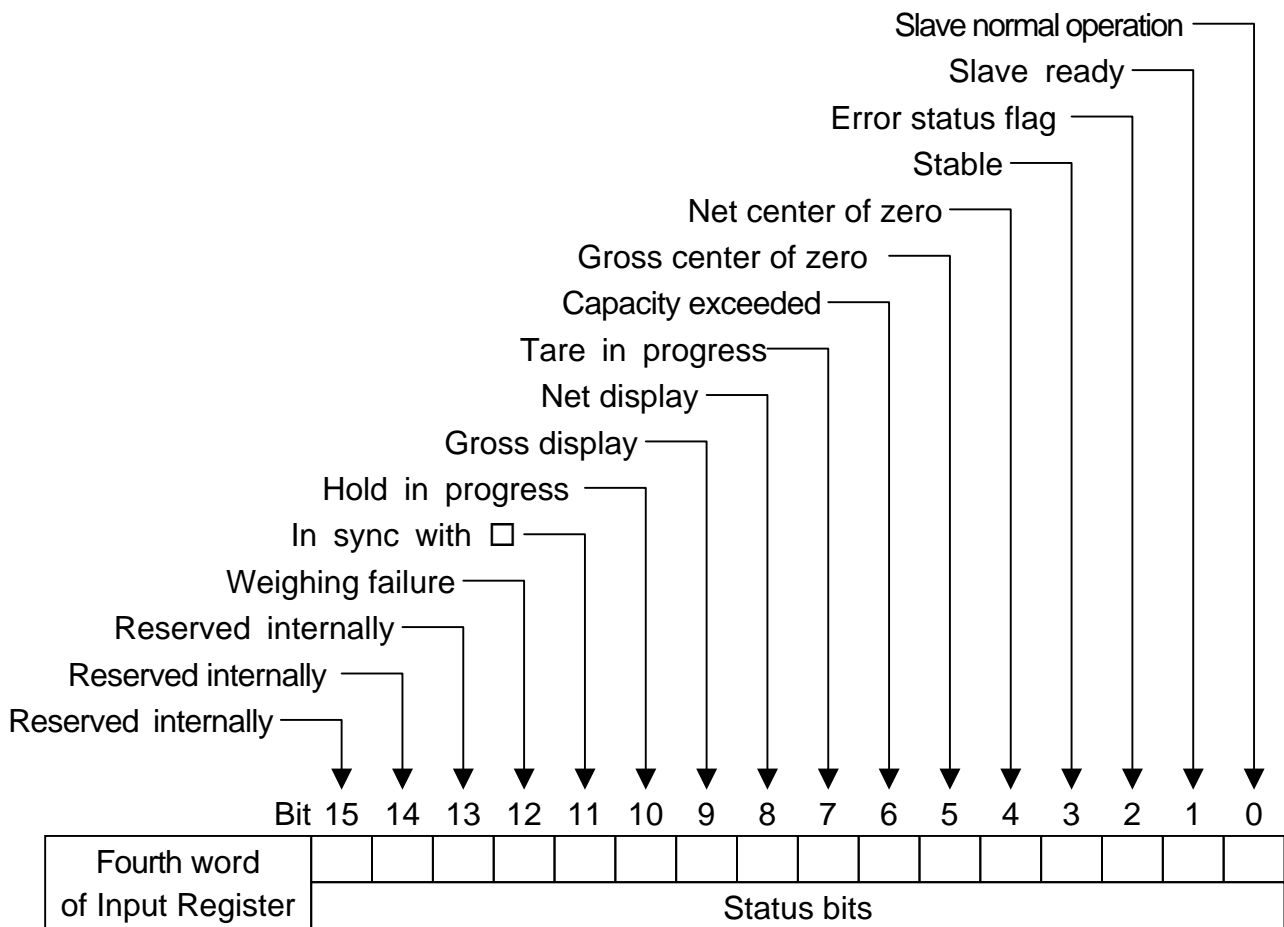

	Bit	15	14	13	12	11	10	9	8	7	6	5	4	3	2	1	0
Fifth word of Input Register	Net weight																
	Weight value (Low order word)																

	Bit	15	14	13	12	11	10	9	8	7	6	5	4	3	2	1	0
Sixth word of Input Register	Net weight																
	Weight value (High order word)																

	Bit	15	14	13	12	11	10	9	8	7	6	5	4	3	2	1	0
Seventh word of Input Register	Gross weight																
	Weight value (Low order word)																

	Bit	15	14	13	12	11	10	9	8	7	6	5	4	3	2	1	0
Eighth word of Input Register	Gross weight																
	Weight value (High order word)																

	Bit	15	14	13	12	11	10	9	8	7	6	5	4	3	2	1	0
Ninth word of Input Register	Tare																
	Weight value (Low order word)																

	Bit	15	14	13	12	11	10	9	8	7	6	5	4	3	2	1	0
Tenth word of Input Register	Tare																
	Weight value (High order word)																

4.2. Handling Bits Directly

4.2.1. Handling Command Bits

- A command bit is in the first word of the Holding Register.
- A command response is in the third word of the Input Register.
- To execute, turn the corresponding command bit ON.
- The command bit will be effective at the rising edge.
The signal level must be maintained for 30 msec minimum.

Table 7 Command bits

	Command bit and action	
First word of Holding Register and third word of Input Register	Bit 0	Zero
	Bit 1	Clear the zero value
	Bit 2	Tare
	Bit 3	Clear the tare value
	Bit 4	Error reset
	Bit 5	Hold
	Bit 6	Manual print command
	Bit 7	Net display
	Bit 8	Gross display

4.2.2. Command bit execution procedure

- Step 1 The master device turns OFF all the command bits.
- Step 2 The master device turns ON the command bit to be executed.
- Step 3 The AD-4408A executes the command and turns ON the corresponding command response.
- Step 4 The master device confirms the command response and turns OFF all the command bits.



5. Timing Chart

Slave Normal Operation

Slave normal operation is a signal to confirm that the AD-4408A is connected to the power and is in normal operating conditions. During normal operation, the signal is reversed at a 0.5 to 1 second interval.

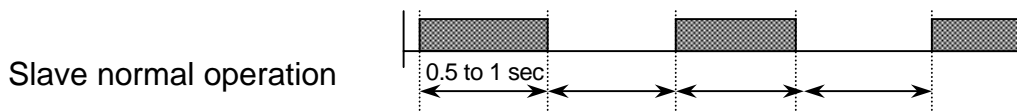

Fig.6 Slave normal operation signal

Error status flag

If an AD-4408A error has occurred, the slave ready bit will be turned OFF and the error status flag will be turned ON to convey to the master device that an error has occurred. The master device will turn the error reset flag ON to request resetting the error status flag.

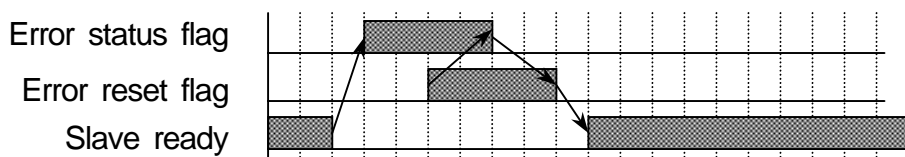

Fig.7 Resetting the error status flag

Table 8 Command bits / Status bits

Memory		Description
First word of Holding Register	Bit 4	Error reset flag
Fourth word of Input Register	Bit 0	Slave normal operation
	Bit 1	Slave ready
	Bit 2	Error status flag



6. Errors

6.1. Error Types

Error Status Flag

This conveys to the master device that an error has occurred.

Turn the error reset flag ON to request resetting the error status flag.

Table 9 Error status flag

Error type	Causes
Checksum error	Program checksum does not match.
Input (A/D) error	Data can not be acquired from the A/D converter.
FRAM error	Data can not be written into the FRAM.
Calibration error	Calibration data is not correct.
Mode error	Moved to a mode other than the weighing mode.

Weighing Failure

This conveys a weighing failure to the master device.

This will be reset when normal weighing has resumed.

Table 10 Weighing failure

Error type	Causes
Zero error	Zero adjustment is not performed.
Tare error	Tare is not performed.
Net display error	A net value is not displayed.
Capacity exceeded	The weighing capacity has been exceeded.

Capacity Exceeded

This conveys to the master device that the weighing capacity has been exceeded.

This will be reset when all the errors are cleared.

Table 11 Capacity exceeded

Error type	Causes
Net over	The net weight is over the net weight range.
Net under	The net weight is below the net weight range.
Gross over	The gross weight is over the gross weight range.
Gross under	The gross weight is below the gross weight range.
A/D over	A/D value is over the A/D value range.
A/D under	A/D value is below the A/D value range.



7. Check Mode

7.1. Checking the Modbus-RTU Communication Status

7.1.1. Entering the Check Mode

Step 1 While pressing and holding the ENTER key, press the F key.

`[FnC]` is displayed to indicate that the indicator will enter the general function mode.

To go back to the weighing mode, press the ESC key.

Step 2 While pressing and holding the ZERO key, press the ENTER key.

`[hc]` is displayed to indicate that the indicator will enter the check mode.

Press the ENTER key again to display an item to be checked.

Step 3 Press the `[^]` or `[v]` key to select `[hcrtu]` (Modbus check mode) and press the ENTER key to enter the Modbus check mode.

To exit from the check mode, press the ESC key.

Table 12 Check mode list

Display	Checking item
<code>[hcPEY]</code>	Key switches
<code>[hc [L]</code>	Standard serial output
<code>[hc***</code> <code>[hcrtu</code> <code>[hc***</code>	Interfaces Modbus-RTU
<code>[hc rS]</code>	Testing terminal
<code>[hc Ad]</code>	A/D (Load cell)
<code>[hc in]</code>	Internal count
<code>[hcPr9]</code>	Program version
<code>[hc Sn]</code>	Serial number
<code>[S Pr9]</code>	Program checksum
<code>[S FrA]</code>	Memory (FRAM) checksum
<code>[ALFdE]</code>	Calibration-related functions

Checking the Communication Status

Press the or key to change addresses.

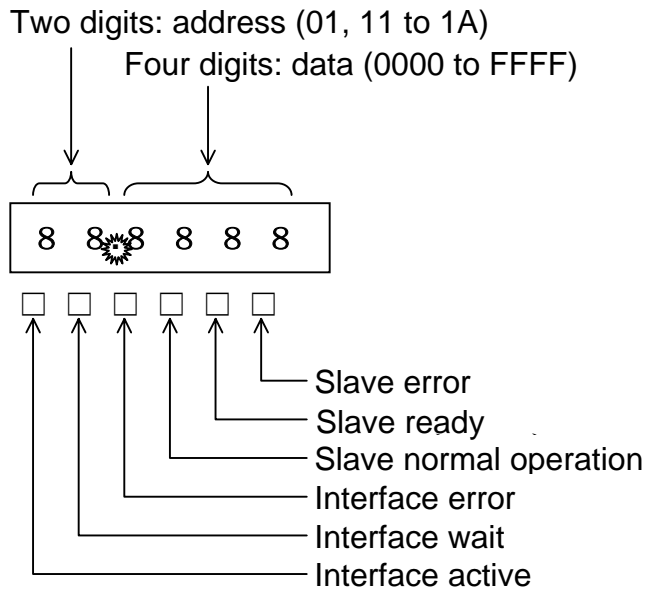

Address	Data type	Word
01	Holding Register	1
11 to 1A	Input Register	1 to 10

