

FG-D-CWP



Weighing Indicator

INSTRUCTION MANUAL

For Waterproof Digital Platform Scale

This Manual and Marks

All safety messages are identified by the following, "WARNING" or "CAUTION", of ANSI Z535.4 (American National Standard Institute: Product Safety Signs and Labels). The meanings are as follows:

 WARNING	A potentially hazardous situation which, if not avoided, could result in death or serious injury.
 CAUTION	A potentially hazardous situation which, if not avoided, may result in minor or moderate injury.

 This is a hazard alert mark.

© 2022 A&D Company Ltd. All rights reserved.

No part of this publication may be reproduced, transmitted, transcribed, or translated into any language in any form by any means without the written permission of A&D Company Ltd.

The contents of this manual and the specifications of the instrument covered by this manual are subject to change for improvement without notice.

Windows, Word and Excel are registered trademarks of the Microsoft Corporation.



Contents

1. COMPLIANCE	4
1.1. COMPLIANCE WITH FCC RULES	4
1.2. CLASSIFICATION OF PROTECTION PROVIDED BY ENCLOSURES	4
2. INTRODUCTION	5
3. OUTLINE AND FEATURES.....	5
4. ITEMS INCLUDED	6
5. INSTALLATION AND PRECAUTIONS.....	7
5.1. PRECAUTIONS FOR INSTALLING THE INDICATOR.....	7
5.2. LOAD CELL CONNECTION	7
5.3. HOW TO CONNECT THE LOAD CELL	9
5.4. VERIFYING LOAD CELL OUTPUT AND INPUT SENSITIVITY	10
5.5. SETTING UP THE INDICATOR	11
5.6. SENSITIVITY ADJUSTMENT AND PARAMETER SETTINGS	12
6. PART NAMES	12
6.1. DISPLAY AND SYMBOLS.....	13
6.2. OPERATION KEYS	14
7. SENSITIVITY ADJUSTMENT.....	15
7.1. SENSITIVITY ADJUSTMENT ITEMS	15
7.2. SETTING OF THE WEIGHING CAPACITY / MINIMUM DIVISION / DECIMAL POINT POSITION	17
7.3. SENSITIVITY ADJUSTMENT USING A WEIGHT	18
7.4. CORRECTING FOR GRAVITATIONAL ACCELERATION	19
8. SETTING FUNCTIONS OR UNITS FOR USE	20
8.1. SETTING OF THE CF FUNCTION	20
8.2. SETTING UNITS FOR USE	21
8.3. CF FUNCTION LIST	22
9. OPTIONS	23
9.1. OPTION LIST.....	23
10.MAINTENANCE.....	24
10.1. REPAIR	24
10.2. ERROR DISPLAY	24
10.3. ERROR CODE TABLE.....	25
11.SPECIFICATIONS	26
11.1. SPECIFICATIONS LIST.....	26
11.2. DIMENSIONS.....	27
11.3. GRAVITY ACCELERATION MAP	28



1. Compliance



1.1. Compliance with FCC rules

- Please note that this equipment generates, uses and can radiate radio frequency energy. This equipment has been tested and has been found to comply with the limits of a Class A computing device pursuant to Subpart J of Part 15 of FCC rules. These rules are designed to provide reasonable protection against interference when this equipment is operated in a commercial environment. If this unit is operated in a residential area, it might cause some interference and under these circumstances the user would be required to take, at his own expense, whatever measures are necessary to eliminate the interference.
(FCC = Federal Communications Commission in the U.S.A.)



1.2. Classification of Protection Provided by Enclosures

- This equipment complies with the IP Code IEC 60529.
The meaning of the IP67 code is as follows:
 - IP : International Protection.
 - 6 : Protection against ingress of dust and airborne particles.
 - 7 : Protection against water and liquids, up to and included submersion of up to one meter.



2. Introduction

Thank you for purchasing an A&D FG-D-CWP weighing indicator (for the IP67 waterproof digital platform scale). This instruction manual mainly describes installation. Please refer to it when connecting or installing the FG-D-CWP to a weighing platform (load cell). Also, the FG-D-CWP has the same functions as that of the indicator for the FG-CWP series. Although this manual covers some of the functions and how to use the series, the following instruction manual explains all of them.

[The instruction manual of the FG-CWP series]

(<https://aandd.jp/products/weighing/scale/platform/fgcwp.html>)

The instruction manual for understanding and fully utilizing the waterproof digital platform scale, the FG-CWP series, can be downloaded from the A&D website (<https://www.aandd.jp>).



3. Outline and Features

The FG-D-CWP is an electronic indicator that is appropriate for composing an IP67 waterproof digital platform scale by connecting to a weighing platform (load cell), and it has the following features.

- The indicator made of all stainless steel and has waterproof/dustproof performance compliant with IP67. (Intrusion of water into the device is prevented even when submerged to a depth of 1 m for 30 minutes.)
- Operating up to four 350Ω load cells is available.
- Available range selection, for the display resolution, is 1/20 to 1/100,000.
- Free setting of the weighing capacity, within the display resolution of 1/100,000, is available.
- Available weighing units are kg (kilogram), g (gram), lb (pound), oz (ounce), t (ton), and pcs (pieces for the counting mode).
- It has similar specifications and functions as an indicator of the FG-CWP series.



4. Items Included

The following items are packed with the product.

- FG-D-CWP

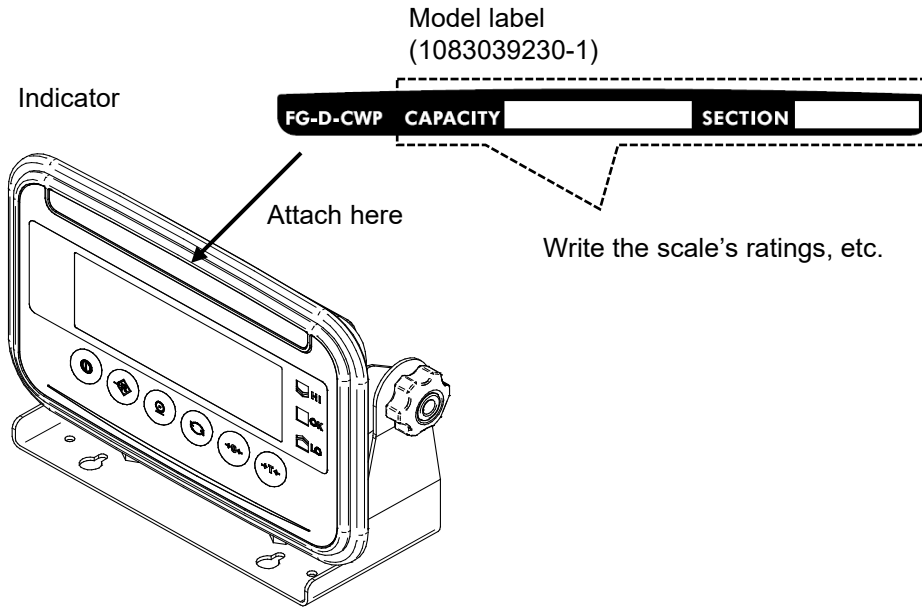

- Quick start guide

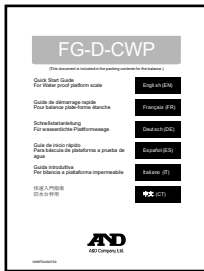

- AC adapter

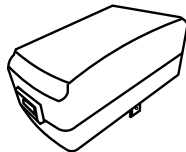

(Image diagram)

- Rubber packing (To be used when the diameter of load cell cable is from $\phi 3.5$ to $\phi 7.0$)



- Rubber feet for display stand (4 pcs.)

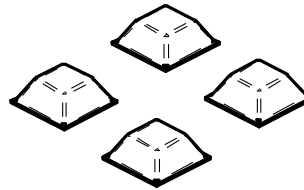



5. Installation and Precautions



5.1. Precautions for Installing the Indicator

DANGER

- Ground the scale, so that the user will not be subjected to an electric shock.
- To prevent electric shock, do not handle the USB cable with wet hands.
- The USB cable is not waterproof. Install the scale in an area where it will not get wet.
- Do not install the scale where flammable or corrosive gas is present.
- Do not put excessive force on cables.
- The scale is heavy. Use caution, as lifting may cause it to fall over.
- Use shielded load cell cables.

Please read "Precautions for Installing the Scale" in [Instruction Manual: FG-CWP Series] (<http://aandd.jp/products/weighing/scale/platform/fgcwp.html>) on the A&D website (<https://www.aandd.jp>) for other precautions, cautions as an assembled scale, storage and cleaning.



5.2. Load Cell Connection

FG-D-CWP has two connection configurations: the 6-wire configuration and the 4-wire configuration. We recommend connecting using the 6-wire configuration for optimum accuracy and stability.

The applicable diameter of load cell cable is from $\phi 3.5$ to $\phi 9.0$ mm.

The length of the load cell cable should be less than 30m. For 4-wire configuration, we recommend using a length of 5m or less.

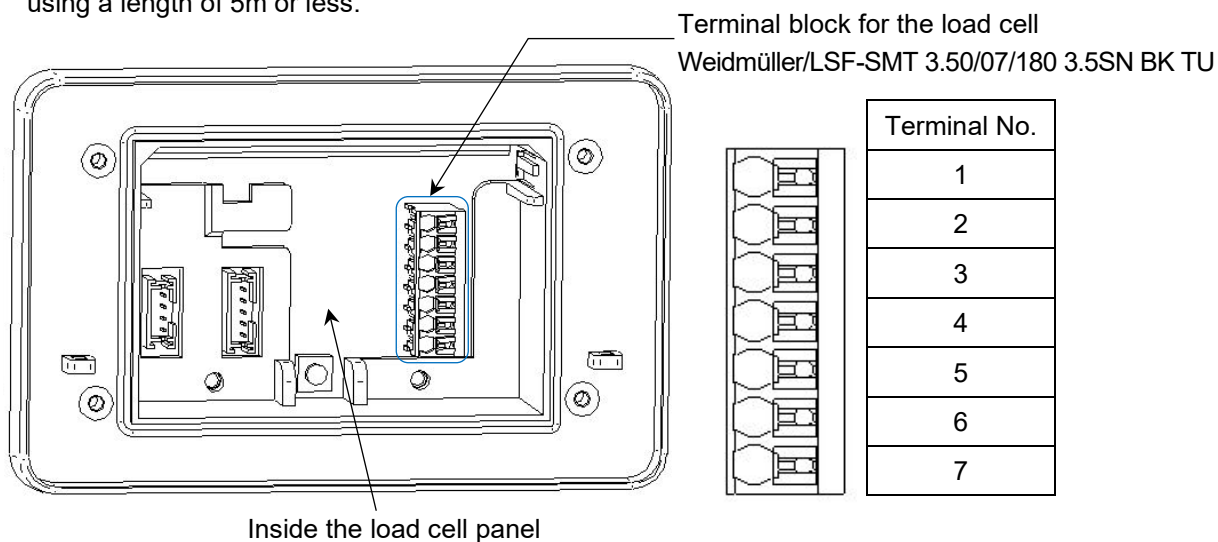

Terminal No.	Function	
1	SIG-	Load cell input (-)
2	SIG+	Load cell input (+)
3	EXC-	Load cell excitation voltage (-)
4	SEN-	Sensing input (-)
5	SEN+	Sensing input (+)
6	EXC+	Load cell excitation voltage (+)
7	SHIELD	Shield

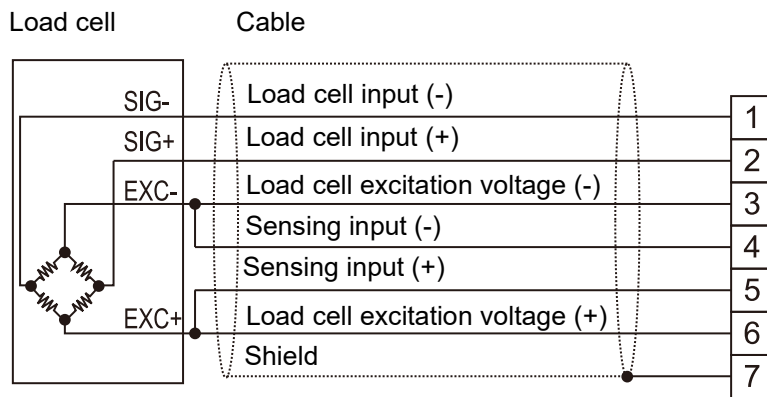

(A) 6-wire configuration connection to load cell (recommended)

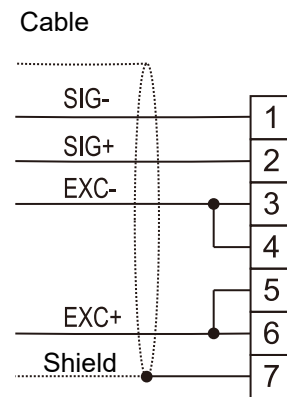

(B) 4-wire configuration connection to load cell

Method	Advantage	Disadvantage	Remark
6-wire configuration (recommended)	Less error even if the length of load cell cable is long or a thin load cell cable is used. Less error even if multiple load cells are used.	Slightly complicated to wire.	When using a summing box, it is strongly recommended wiring be done with the 6-wire configuration.
4-wire configuration	Easy to wire.	The accuracy of temperature counting is affected by resistance of the conductor wire for the load cell cable. It is affected by contact resistance of the connector.	Using a long load cell cable or multiple load cells tends to cause error.

Precautions for connecting with the 4-wire configuration

Make sure to do the following when connecting with the 4-wire configuration.

- Short-circuit between EXC+ and SEN+, and between EXC- and SEN-.
- When using a long a load cell cable, use one with a cross-sectional area that is as large as possible. Also, use a cable that is as short as possible.

※ Ref.: Connection examples of connecting to the SCB series, Dust & Waterproof Precision Weighing Platform (with the 4-wire configuration)

Load cell terminal number	Color of cable core for the SCB series	Function of terminals for SCB series
1	Blue	Signal - (Output terminal)
2	Green	Signal + (Output terminal)
3, 4	White	Excitation - (Input terminal)
5, 6	Red	Excitation + (Input terminal)
7	Yellow	Shield



5.3. How to Connect the Load Cell

1. Disconnect the power cable of the scale (indicator) from the plug.

2. Remove the 4 M3 screws from the load cell panel on the backside of the indicator, and open the load cell panel.

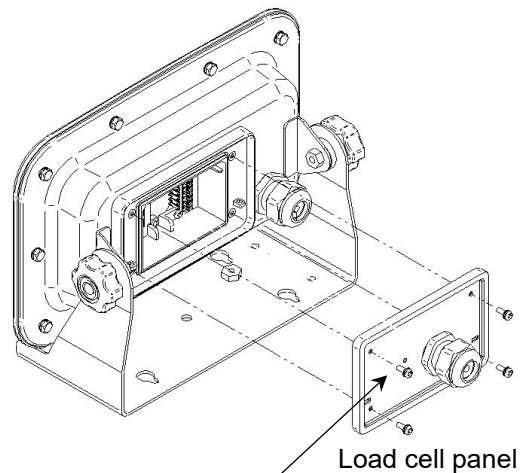

3. Loosen the lock of the cable clamp connecting to the load cell panel, and pass the load cell cable through. Fit the rubber packing in the load cell cable.

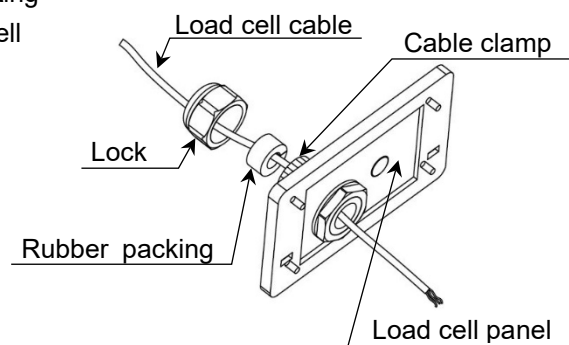

□ The applicable diameter of load cell cable is from $\phi 3.5$ to $\phi 9.0$ mm.

If the diameter of cable is from $\phi 3.5$ to $\phi 7.0$, replace the cable clamp with the accessory rubber packing that is packed with the product.

※ If the diameter of cable is from $\phi 7.0$ to $\phi 9.0$, the cable clamp does not need to be replaced.

4. Refer to “5.2. Load Cell Connection”, and connect the cable core to the terminal block of the load cell.
 - Hold down the white button on each terminal in the terminal block of the load cell when connecting or disconnecting the wire. (Additional tool is not required.)

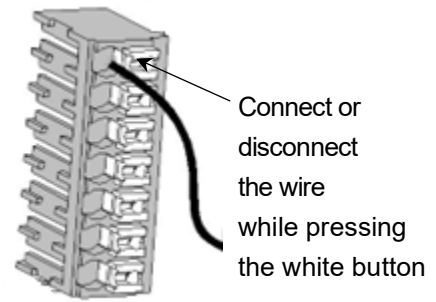

5. Once the load cell is connected, make sure that wiring has been done correctly.
6. Fasten the lock of the cable clamp, and secure the load cell cable.
7. Secure and close the load cell panel with the 4 screws.
 - To maintain water-proof performance, tighten the cable clamp firmly when connecting the load cell cable. And tighten the bolts on the rear panel firmly. The recommended torque is 0.4 N·m (4 kgf·cm).



5.4. Verifying Load Cell Output and Input Sensitivity

The input sensitivity is 0.1 μV/division or more. When designing a weighing scale, the following calculation formula should be satisfied.

- The input sensitivity requires a change in output voltage, from the weighing device, to change the display value as a one digit step. In order to achieve a scale with stable performance, select the input sensitivity as large as possible.

Calculating formula:

$$0.1 \leq \frac{E \times B \times d}{A \times n}$$

- A:** Rated capacity of load cell
- B:** Rated output (mV/V)
- d:** Minimum division
- E:** Excitation voltage (mV) = 5000 mV for FG-D-CWP
- n:** Number of load cells

Example of calculation:

In the case of designing a scale with a capacity of 60 kg and minimum division of 0.005 kg, using one load cell with a rated capacity of 100 kg and rated output of 1 mV/V:

Rated capacity of Load cell:	A = 100 kg	$\frac{5000 \times 1 \times 0.005}{100 \times 1} = 0.25 > 0.1$
Rated output:	B = 1 mV/V	
Minimum division:	d = 0.005 kg	
Excitation voltage:	E = 5000 mV	
Number of load cells:	n = 1	

The above indicates there is no problem with this design.



5.5. Setting Up the Indicator

1. When using the display stand/wall-mount bracket as a display stand, attach the 4 included rubber feet to the four corners of the bottom as needed.

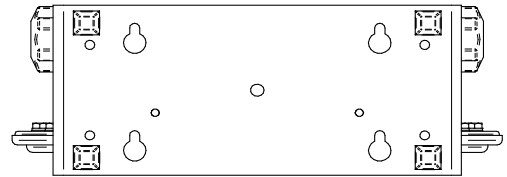
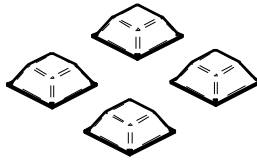

2. Follow the steps below to change the angle of the display.
 - 1) Turn and loosen the two indicator knobs behind the display.
 - 2) Tilt the display to the desired angle.
 - 3) Tighten the indicator knobs loosened in step 1.

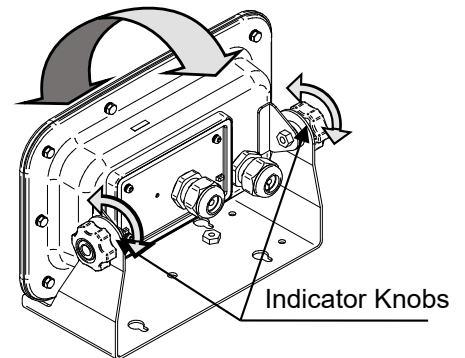

3. When using the display stand/wall-mount bracket as a wall-mount bracket, screw the stand part into a flat wall surface (screws not included). For details on installation dimensions, refer to "[11.2. Dimensions.](#)"

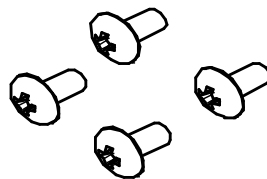

M4 Truss Screws

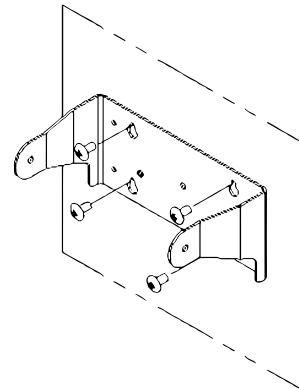

4. Insert the USB plug into the AC adapter included with this product and connect it to the power supply.
 - Confirm that local voltage and receptacle type are correct.
 - You can also use except for the AC adapter included with this product. This product can also be powered from a USB port or mobile battery.

Note: Not all operations are guaranteed.

- The USB cable serves as both a power and a communication.

 If using the scale in a location where static electricity is easily generated or where it may get wet, secure the grounding wire with the protective grounding terminal (screw).

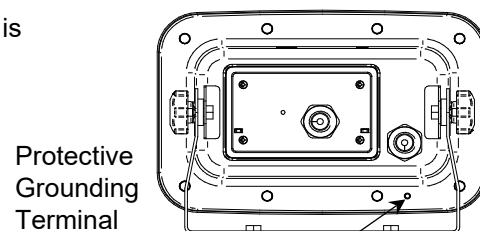

Protective Grounding Terminal

Rear of Display Unit



5.6. Sensitivity Adjustment and Parameter Settings

When connecting to a load cell (weighing platform), sensitivity adjustment needs to be performed. For details, refer to “[7. Sensitivity Adjustment](#)”.

As needed, configure the function settings. For details, refer to “[8. Setting Functions or Units for Use](#)”.



6. Part Names

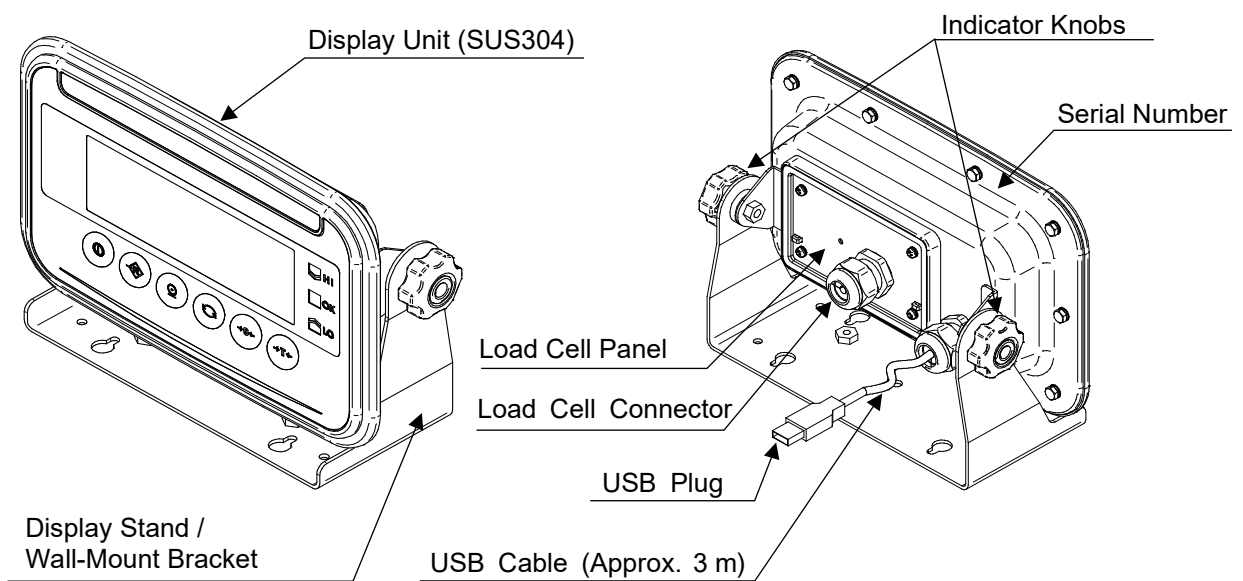



6.1. Display and Symbols

Display Unit

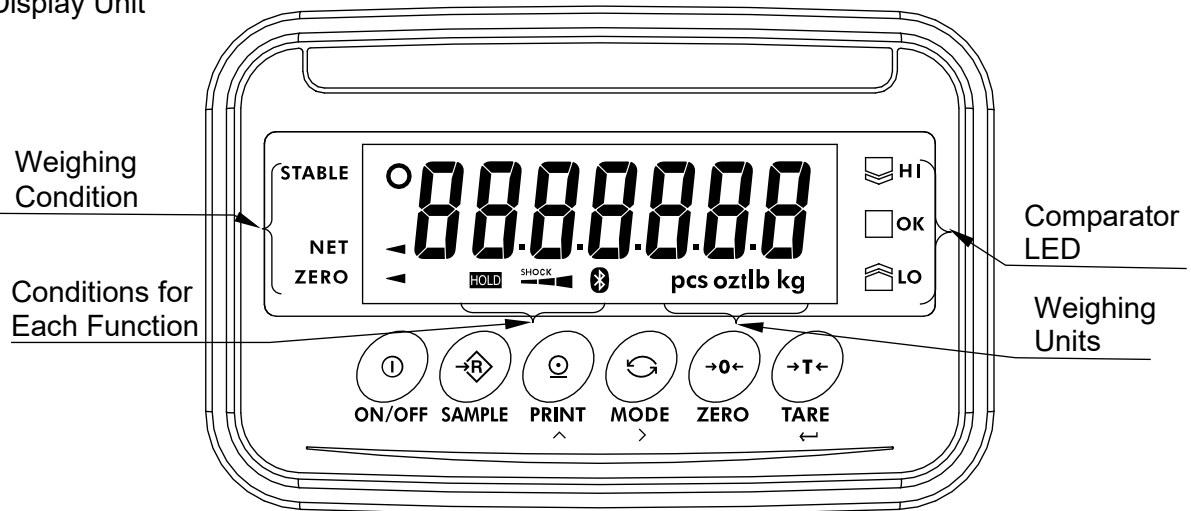



Display/symbol	Description
STABLE ○	This is lit when the weighing value is stable, indicating that the scale is in the proper condition for reading weighing values.
NET ◀	This is lit when weight of the container (tare) is subtracted.
ZERO ◀	This is lit when the scale is at the zero point (reference point for weighing).
Weighing Units	“ kg ”, “ g ”, “ pcs ”, “ oz ”, “ lb ” and “ t ” is lit.
HOLD	This is lit when the display is held.
SHOCK ◀▶	This is a function to detect impact to the mass sensor section and to display the impact level.
	Turns on when the connection with the wireless communication receiver is established.
HI OK LO	While the comparator function is being used, the weighing value is compared using the preset threshold values and the indicator displays the result.

- For details on the method of operation and various functions, refer to the [Instruction Manual: FG-CWP Series] (<https://aandd.jp/products/weighing/scale/platform/fgcwp.html>) on our website <https://www.aandd.jp>.

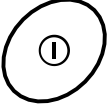

6.2. Operation Keys

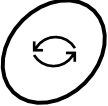
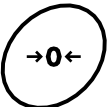
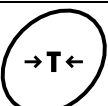
Operation key	Description
 ON/OFF	ON/OFF Key Shows or hides the display.
 SAMPLE	SAMPLE Key Selecting " pcs " as the unit activates individual weight setting mode. Pressing and holding (for about 2 seconds) activates the comparator threshold setting mode.
 PRINT	PRINT Key Outputs the weighing value as data. Increases the value of the digit flashing when setting.
 MODE	MODE Key Switches the weighing unit. Shifts to the right the digit flashing when making settings.
 ZERO	ZERO Key Based on the zero point weighed at the time of turning on the display, by pressing the ZERO key when the weight value is stable within ± 2 % of the weighing capacity, the zero point indicator turns on as soon as the display becomes zero.
 TARE	TARE Key The weight of the item on the weighing pan is subtracted as the weight of a container (tare weight).



7. Sensitivity Adjustment

- The description of sensitivity adjustment in this manual is different from that in the instruction manual for the FG-CWP series. Please read the description below.



7.1. Sensitivity Adjustment Items

Sensitivity adjustment mode has the following three functions.

- Setting of the weighing capacity, minimum division, and decimal point position.
- Sensitivity adjustment using a weight
- Correcting for gravitational acceleration

There are two ways to enter sensitivity adjustment mode as shown below.

Method 1 (using operation keys)

1. Confirm that the scale(indicator) is in weighing mode (display shows measurement unit).
2. Press and hold the **TARE** key for 4 sec. or longer. Release the key when **CALSET** is displayed. (Then go to “7.2. Setting of the Weighing Capacity / Minimum Division / Decimal Point Position”, “7.3. Sensitivity Adjustment Using a Weight”, or “7.4. Correcting for Gravitational Acceleration”.)

Method 2 (using the CAL switch)

1. Confirm that the scale(indicator) is in weighing mode (display shows measurement unit).
2. Remove the protective cover from the four screws of the load cell panel on the rear of the display unit, and then loosen the four screws and open the load cell panel.
3. Press the CAL switch to display **CALSET**. (Then go to 7.2. Setting of the Weighing Capacity / Minimum Division / Decimal Point Position”, “7.3. Sensitivity Adjustment Using a Weight”, or “7.4. Correcting for Gravitational Acceleration”)

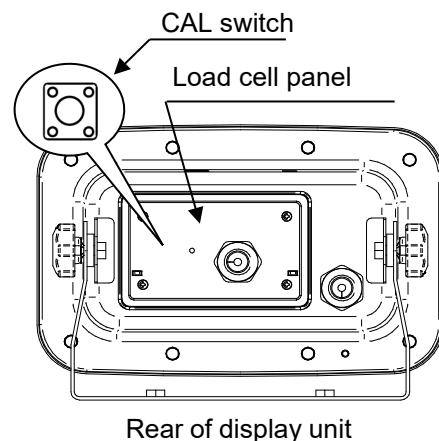

- Relations between items in sensitivity adjustment mode and key operations are shown in the diagram below.

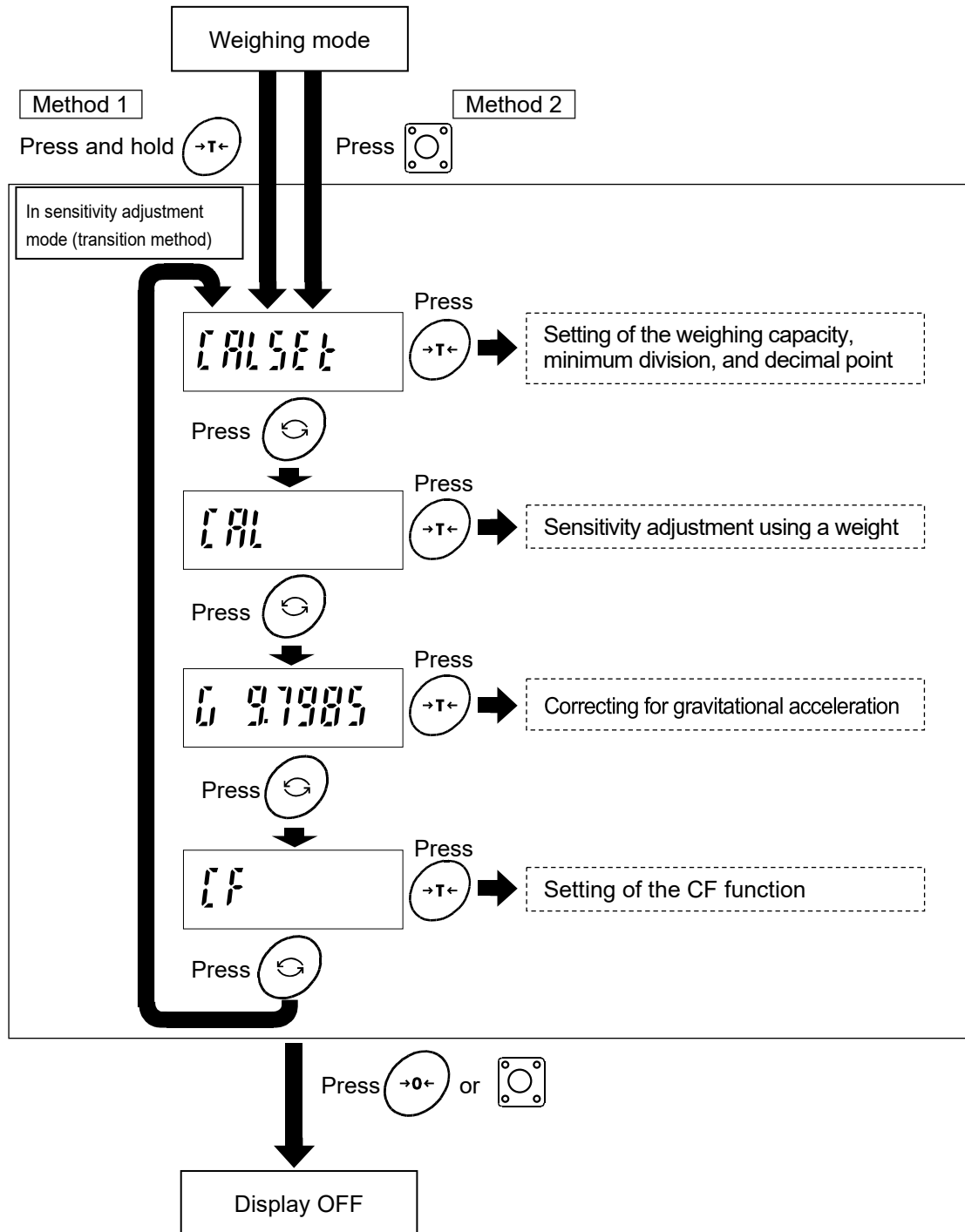

Note: Use the **MODE** key to select the item to execute, and then execute with the **TARE** key.

Note: To end sensitivity adjustment mode, press the **ZERO** key or CAL switch. The display turns off. (You can also turn it off using the ON/OFF switches.)



7.2. Setting of the Weighing Capacity / Minimum Division / Decimal Point Position

Set the weighing capacity, minimum division, and decimal point position. Be sure to perform these setting first when connecting to a load cell (base unit). The indicator does not require setting each time, if nothing is to be changed.

1. Refer to “7.1. Sensitivity Adjustment Items”, to enter the calibration mode. The indicator displays **CALSET**.

2. Press the **TARE** key to enter the setting mode of the weighing capacity, minimum division, and decimal point position.

3. The indicator displays the currently set minimum division and calibration unit.

(Display example: **d - 1 kg**)

The blinking digit indicates the minimum division. Press the **PRINT** key to select 1, 2, or 5. The unit indicates the sensitivity adjustment unit. Press the **SAMPLE** key to select either “kg” or “lb”.

Press the **TARE** key to store the currently set minimum division and calibration unit, and proceed to the next step.

4. After displaying **CAP**, the indicator displays the currently set weighing capacity and decimal point position. (Display example: **060000 kg**)

Set the weighing capacity and decimal point position using the following keys:

- MODE** Shift the blinking digit to the right.
- PRINT** Increases the number (+1) at the blinking digit.
- SAMPLE** Shift the decimal point position.

Press the **TARE** key to store the currently displayed weighing capacity and decimal point position, and proceed to the next step.

- Available setting range of the resolution is 100,000 or less. The resolution is the value that divides the weighing capacity by the minimum division. (Decimal point position is ignored.)

5. After displaying **End**, the indicator displays **CALSET**, and the setting is complete.

After setting the weighing capacity, minimum division, and decimal point position, be sure to perform “7.3. Sensitivity Adjustment Using a Weight”.

CALSET

Press **→T←**

d - 1 kg

Press (Select) **⊙** **→R**

d - 1 kg lb

Press **→T←**

CAP

060000 kg

Press (Select) **⊙** **↻** **→R**

050000 kg

Press **→T←**

End

CALSET



7.3. Sensitivity Adjustment Using a Weight

This function adjusts the scale (indicator) for accurate weighing.

Sensitivity adjustment must be done when the FG-D-CWP is initially connected to a load cell (base unit) or the combination is changed.

Sensitivity adjustment may also be required according the changes in the environment.

- When the scale (indicator) is initially installed.
- When the scale (indicator) is moved to a location far away.
- When the ambient environment has greatly changed.
- In periodic sensitivity adjustment

Note: Prepare a weight. (A weight equivalent to the weighing capacity of the scale to be adjusted is recommended. However, the value for the weight can be set (changed).)

1. Turn on the scale and supply it with power for 30 minutes or longer.

- Change the parameter for the function table item `POFF` or place something on the weighing pan to keep the automatic power off function from activating.

2. Refer to "7.1. Sensitivity Adjustment Items". `CALSET` is displayed when you enter sensitivity adjustment mode.

3. Press the `MODE` key to display `CAL`.

4. Press the `TARE` key to display `CAL 0`.

Make sure there is nothing on the weighing pan and wait for the stability indicator to light up.

5. Press the `TARE` key to save the zero point on the scale and display the value for the weight.

- The value for the weight is the same as the weighing capacity. (Initial state)
- To adjust just the zero point, turn off the scale to end without performing step 6.

6. To adjust with a weight value different than the weighing capacity, change the value with the keys below.

Key	Content
	Moves the blinking digit
	Increases the blinking digit by 1

- A weight equivalent to the weighing capacity of the scale is ordinarily used. If using a different weight, it should be at least 2/3 the weighing capacity.

`CALSET`

Press

`CAL`

Press

`CAL 0` kg

Press

`000.0000` kg

Press (Select)

`005.0000` kg

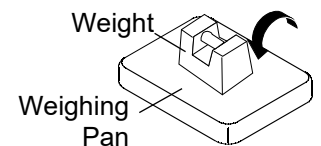

`005.0000` kg

Press

`End`

`CAL`

7. Place on the weighing pan a weight of the value displayed. Wait for the stability indicator to light up.
8. Press the **TARE** key to end sensitivity adjustment. **End** will be displayed.
After displaying **CAL**, the setting is complete.

9. To end setting, press the **ZERO** key or CAL key. The display turns off.

Note: If the scale (indicator) is moved to a distant location after sensitivity adjustment, adjust the gravitational acceleration value to that of the area where it will be adjusted next. Then adjust the scale. See the next chapter for setting gravitational acceleration.



7.4. Correcting for Gravitational Acceleration

When relocating a scale (indicator), you need to perform sensitivity adjustment with a weight. If a weight is not available, you can adjust the scale (indicator) by correcting the gravitational acceleration. Refer to the acceleration map on the last page, and change the gravitational acceleration value recorded in the scale (indicator) to the one for appropriate location.

Note: If sensitivity adjustment is done using a weight at the place where the scale (indicator) is used, it does not need to be corrected for gravitational acceleration.

1. Refer to “7.1. Sensitivity Adjustment Items”. **CALSET** is displayed when you enter sensitivity adjustment mode.
2. Press the **MODE** key twice to display the gravitational acceleration parameter (Example: “G 9.7985”).
3. Press the **TARE** key to enter the gravitational acceleration setting mode.
4. To change the gravitational acceleration parameter displayed, use the keys below.

Key	Content
	Moves the blinking digit
	Increases the blinking digit by 1

5. Press the **TARE** key to display **End** and save the parameter. After displaying the gravitational acceleration parameter (Example: “G 9.7985”), the setting is complete.
6. To adjust using a weight, return to step 2 of “7.3. Sensitivity Adjustment Using a Weight”. To end setting, press the **ZERO** key or CAL key. The display turns off.

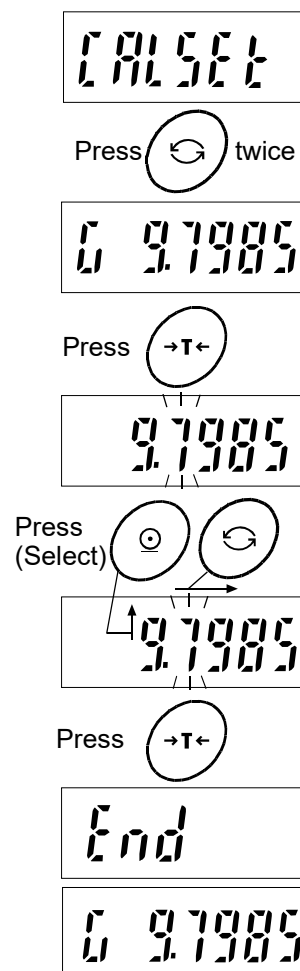



8. Setting Functions or Units for Use

The indicator has CF function settings to specify the indicator performance.

After installing the indicator, the indicator does not require resetting or changing of this CF function as far as it is used normally. If you want to maintain only the needed units, set using this function.

The parameters set in the CF function settings and unit setting are maintained even if the power is turned OFF.



8.1. Setting of the CF Function

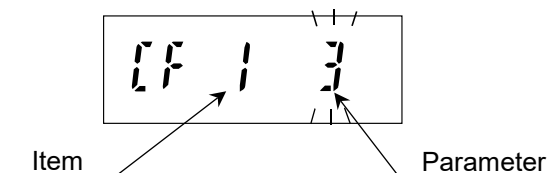

1. Refer to “7.1. Sensitivity Adjustment Items”, to enter the sensitivity adjustment mode. The indicator displays `CALSET`.
2. Press the `MODE` key three times to display `CF`.
3. Press the `TARE` key to display the setting item.
4. Select the setting item and parameter using the following keys:
 - `MODE` Proceed to next setting item.
 - `PRINT` Increases the number (+1) at the blinking digit.
(Change the parameter)
 - When the currently stored set is changed, the STABLE indicator “○” turns off.
 - Changing the parameter using the `PRINT` key at CF1, 2, 8, 12 or 13 is not available.
5. Press the `TARE` key to store the setting. After displaying `End`, the indicator displays `Unit` and proceeds to the unit setting mode.
 - To proceed, without storing the CF function setting, press the `ZERO` key. After displaying `Unit`, proceed to the use unit setting mode. (Display example: `1110000 pcs`)
6. When the unit setting is to be performed, go to step 5 of “8.2. Setting the unit for use”.
When the unit setting is not to be performed, press the `ZERO` key. After displaying `CF`, the setting is complete.
 - To adjust to the designed scale specification, set other items by following the procedure described above.



`CALSET`

Press  3 times

`CF`

Press 

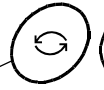
`CF 1 0`

Press (Select)  

`CF 3 1`

Press  `End`

`Unit`

`1110000`
pcs



8.2. Setting Units for Use

1. Refer to “7.1. Sensitivity Adjustment Items”, to enter the sensitivity adjustment mode. The indicator displays **[CALSET]**.

CALSET

2. Press the **[MODE]** key three times to display **[CF]**.

Press  3 times

CF

3. Press the **[TARE]** key to display the setting item.

Press 

CF 1 0

4. To proceed without storing this setting item, press the **[ZERO]** key. After displaying **[Unit]**, proceed to the unit setting mode. (Display example: **1110000 pcs**)

Press 

Unit

1110000 pcs

5. Select the unit to be used, using the following keys.

[MODE] Select the unit (Shift the blinking unit to the right)

[PRINT] Set whether the selected unit is available (0) or not available (1). (Change the number of the blinking digit to “0” or “1”.)

Press (Select)  

10 10000 pcs

- About the unit setting mode

Each of the display digits are assigned to a unit setting. (The setting at the first and fourth digit is not available.)

Display assignment	7	6	5	4	3	2	1
Unit	pcs	g	kg	Set disabled	oz	lb	t

- The unit during selection is indicated.
- With each digit, if setting to “0”, its unit is not available, and if setting to “1”, its unit is available. (Only when set to “1”, is a unit available.)
Even if a unit is stored, availability for use depends on the weighing capacity and resolution.
Example) When setting to **10 10000 pcs**, only “pcs” and “kg” are available as units.

6. Press the **[TARE]** key to store the setting. After displaying **[End]**, the indicator displays **[CF]**, and the setting is complete.

Press 

End

- If you want to proceed without storing the setting of the unit setting mode, press the **[ZERO]** key. After displaying **[CF]**, the setting is complete.

CF



8.3. CF Function List

Item	Parameter	Description	
Used internally [CF 1]	◆ 0	Not available for setting change	
Used internally [CF 2]	◆ 0	Not available for setting change	
Zero tracking [CF 3]	0	Not available for setting of function [t _{rc}] (It is fixed to [t _{rc} 1])	When [CF 3 0], [t _{rc}] has no function.
	◆ 1	Available for setting of function [t _{rc}]	
Power on zero range [CF 4]	0	None	Calibration zero reference
	1	±10 % of weighing capacity	
	◆ 2	±50 % of weighing capacity	
	3	±100 % of weighing capacity	
Calculation of tare [CF 5]	0	Tare by displayed division	
	◆ 1	Tare by internal count	
Zero-point mark during tare subtraction [CF 6]	0	Do not illuminate the zero-point mark during tare subtraction	
	◆ 1	Illuminate the zero-point mark during tare subtraction only when the net weight is zero	
	2	Illuminate the zero-point mark during tare subtraction	
Tare clear by zero operation [CF 7]	0	Tare is not cleared by zero operation	
	◆ 1	Tare is cleared by zero operation	
Used internally [CF 8]	◆ 3	Not available for setting change	
Minus and printing limit [CF 9]	◆ 0	Non-limit	Refer to below note.
	1	Limit has function	
Comparator Negative Comparison [CF 10]	0	Without Comparator Negative Comparison	When [CF 10 0], [P-P] has no function.
	◆ 1	With Comparator Negative Comparison	
Stable detection range [CF 11]	0	Not available for setting of function [St-b] (It is fixed to [St-b 0])	When [CF 11 0], [St-b] has no function.
	◆ 1	Available for setting of function [St-b]	
Used internally [CF 12]	◆ 3	Not available for setting change	

Item	Parameter	Description	
Used internally [CF 13]	◆ 0	Not available for setting change	
Saving zero value and tare weight [CF 14]	◆ 0	Do not save	Saves zero value and tare weight even after the power turns off.
	1	Save	
Display limit of "E" [CF 15]	◆ 0	Weighing capacity + 8 d	
	1	Weighing capacity + 8 d + (capacity/30)	
	2	Weighing capacity + 8 d + (capacity/15)	
	3	Weighing capacity + 8 d + (capacity/6)	
	4	Weighing capacity + 8 d + (capacity/3)	
Zero tracking width/ time [CF 16]	0	0.5 d / 0.5 seconds	
	◆ 1	0.5 d / 1.0 seconds	
	2	0.5 d / 1.5 seconds	
	3	0.75 d / 0.5 seconds	
	4	0.75 d / 1.0 seconds	
	5	0.75 d / 1.5 seconds	
	6	1.0 d / 0.5 seconds	
	7	1.0 d / 1.0 seconds	
	8	1.0 d / 1.5 seconds	
		Zero tracking: The function to track the zero point and keep the display zero	

◆: Factory settings (which differ depending on the destination market) d = minimum division
The settings are not changeable for CF1, 2, 8, 12, or 13.

Note: About minus and printing limit setting ([CF 9])

When setting [CF 9] to "1", the indicator has the following limit.

When the total weight is less than -19d, the indicator displays [-E].

When the total weight is minus, the indicator does not perform the printing.



9. Options



9.1. Option List

Option name	Contents
FG-27CWP	Bluetooth® communication interface
AD-8541-PC	Bluetooth® dongle for PC connection
AD-8931	Bluetooth® External Display
AX-TB301	AC adapter

Refer to the optional instruction manual for details.



10. Maintenance

- Refer to “5. Installation and Precautions” regarding use.
- Refer to “10.3. Error Code Table” and corresponding mode for displayed error code.
- Refer to “7. Sensitivity Adjustment” regarding precision weighing.
- Periodically check the accuracy of weighing. Adjust the scale (indicator), if it is moved to another location or the environment has changed.



10.1. Repair

Do not disassemble / assemble the indicator without an authorized service engineer. Doing so may cause an electric shock or damage to the indicator, etc. In this case, repair is not covered under warranty. Contact your local A&D dealer if your indicator needs service or repair.

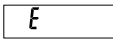
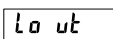
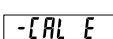
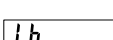
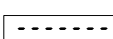
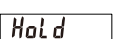

10.2. Error Display

In this situation	Confirm these items
Nothing displayed. Scale does not turn on.	<ul style="list-style-type: none"> □ Is the main power the correct voltage? □ Is the main power cord properly connected?
The scale does not display zero at first.	<ul style="list-style-type: none"> □ Check around the weighing pan. □ Is there anything on the weighing pan? □ Refer to “7. Sensitivity Adjustment” and perform zero point sensitivity adjustment.
 is displayed.	<ul style="list-style-type: none"> □ Weighing error that meaning "Overloaded".
 is displayed.	<ul style="list-style-type: none"> □ Indicates that the sample weight is too light to set the unit weight in the counting mode.
 is displayed.	<ul style="list-style-type: none"> □ Sensitivity adjustment error that meaning "Too light".
 is displayed.	<ul style="list-style-type: none"> □ Displayed when the main power drops.
 is displayed and does not proceed.	<ul style="list-style-type: none"> □ The weighed value is unstable due to drift, vibration or other factors. A breeze or vibration may be affecting measurement. Check around the weighing pan. □ Check the connection of the load cell cable. □ No zero display when the display is turned on. Remove anything that is on the pan. □ Perform zero point sensitivity adjustment.
Fixed display.	<ul style="list-style-type: none"> □ Did you use the "hold function" ? Refer to the [FG-CWP Series Instruction Manual] on the A&D website (https://www.aandd.jp) and change the function . □ Turn off scale and turn it on again.



10.3. Error Code Table

When any of the following errors are displayed, try turning the display off and on again.

Display	Content
<i>Error 0</i> is displayed	The temperature sensor has failed.
<i>Error 3</i> is displayed	The memory (circuit) has failed.
<i>Error 4</i> is displayed	The internal circuitry has failed.
<i>Error 5</i> is displayed	The mass sensor has failed.



11. Specifications



11.1. Specifications List

- Specifications are subject to change without notice.

Input sensitivity	0.1 $\mu\text{V}/\text{d}$ min. (d: minimum division)
Input signal range	-16 mV to 16 mV
Load cell excitation voltage	5 V \pm 10 %
Load cell drive capacity	Up to 4 x 350 ohm loadcells
Temperature coefficient Zero	$\pm 0.02 \mu\text{V}/^\circ\text{C}$ typ. $\pm 0.1 \mu\text{V}/^\circ\text{C}$ max.
Temperature coefficient Span	$\pm 3 \text{ ppm}/^\circ\text{C}$ typ. $\pm 15 \text{ ppm}/^\circ\text{C}$ max.
Linearity	± 0.01 % of full scale
Maximum display resolution	100,000
Display	7 segment LCD with backlight (Character height 30 mm)
Display update	Approx. 10 times/second
Operating Conditions	-10 $^\circ\text{C}$ to 40 $^\circ\text{C}$, 85 % R.H. or less (non-condensing)
Power Supply	AC adapter or mobile battery or USB port USB Cable Length: Approx. 3 m (USB cable is also used for communication.)
Dimensions	Width 240 mm \times Depth 76 mm \times Height 155 mm
Weight (approximately)	1.6 kg (Includes stand)
Dust and water protection	IP67



11.2. Dimensions

FG-D-CWP

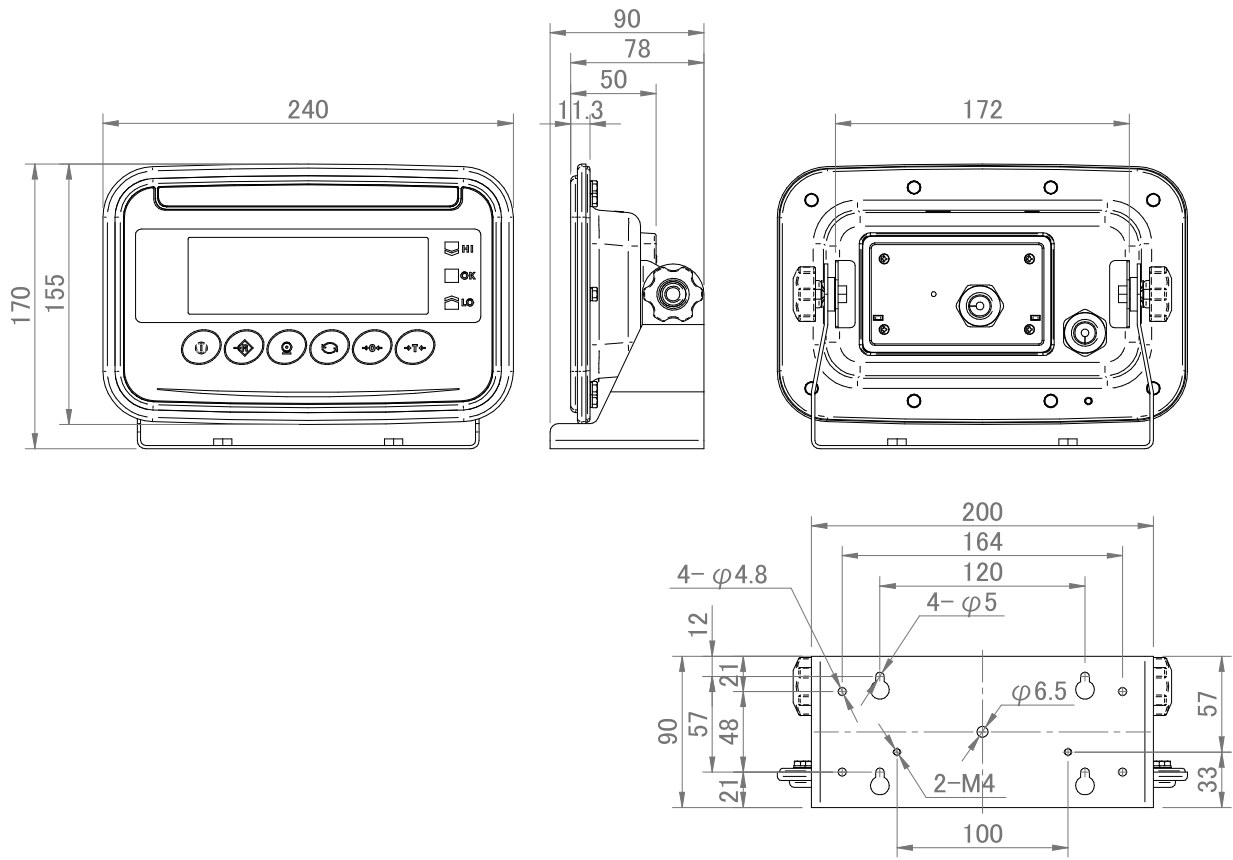

Unit: mm



11.3. Gravity Acceleration Map

Values of gravity at various locations

Amsterdam	9.813 m/s ²	Manila	9.784 m/s ²
Athens	9.800 m/s ²	Melbourne	9.800 m/s ²
Auckland NZ	9.799 m/s ²	Mexico City	9.786 m/s ²
Bangkok	9.783 m/s ²	Milan	9.807 m/s ²
Birmingham	9.813 m/s ²	Moscow	9.816 m/s ²
Brussels	9.811 m/s ²	New York	9.802 m/s ²
Buenos Aires	9.797 m/s ²	Oslo	9.819 m/s ²
Cape Town	9.796 m/s ²	Ottawa	9.807 m/s ²
Chicago	9.803 m/s ²	Paris	9.810 m/s ²
Copenhagen	9.816 m/s ²	Rio de Janeiro	9.788 m/s ²
Cyprus	9.797 m/s ²	Rome	9.803 m/s ²
Frankfurt	9.811 m/s ²	San Francisco	9.800 m/s ²
Glasgow	9.816 m/s ²	Singapore	9.780 m/s ²
Havana	9.788 m/s ²	Stockholm	9.819 m/s ²
Helsinki	9.819 m/s ²	Sydney	9.796 m/s ²
Jakarta	9.781 m/s ²	Taichung	9.789 m/s ²
Kolkata (Calcutta)	9.788 m/s ²	Taipei	9.790 m/s ²
Kuwait	9.793 m/s ²	Tokyo	9.798 m/s ²
Lisbon	9.801 m/s ²	Vancouver, BC	9.810 m/s ²
London (Greenwich)	9.812 m/s ²	Washington DC	9.801 m/s ²
Los Angeles	9.797 m/s ²	Wellington NZ	9.803 m/s ²
Madrid	9.802 m/s ²	Zurich	9.808 m/s ²

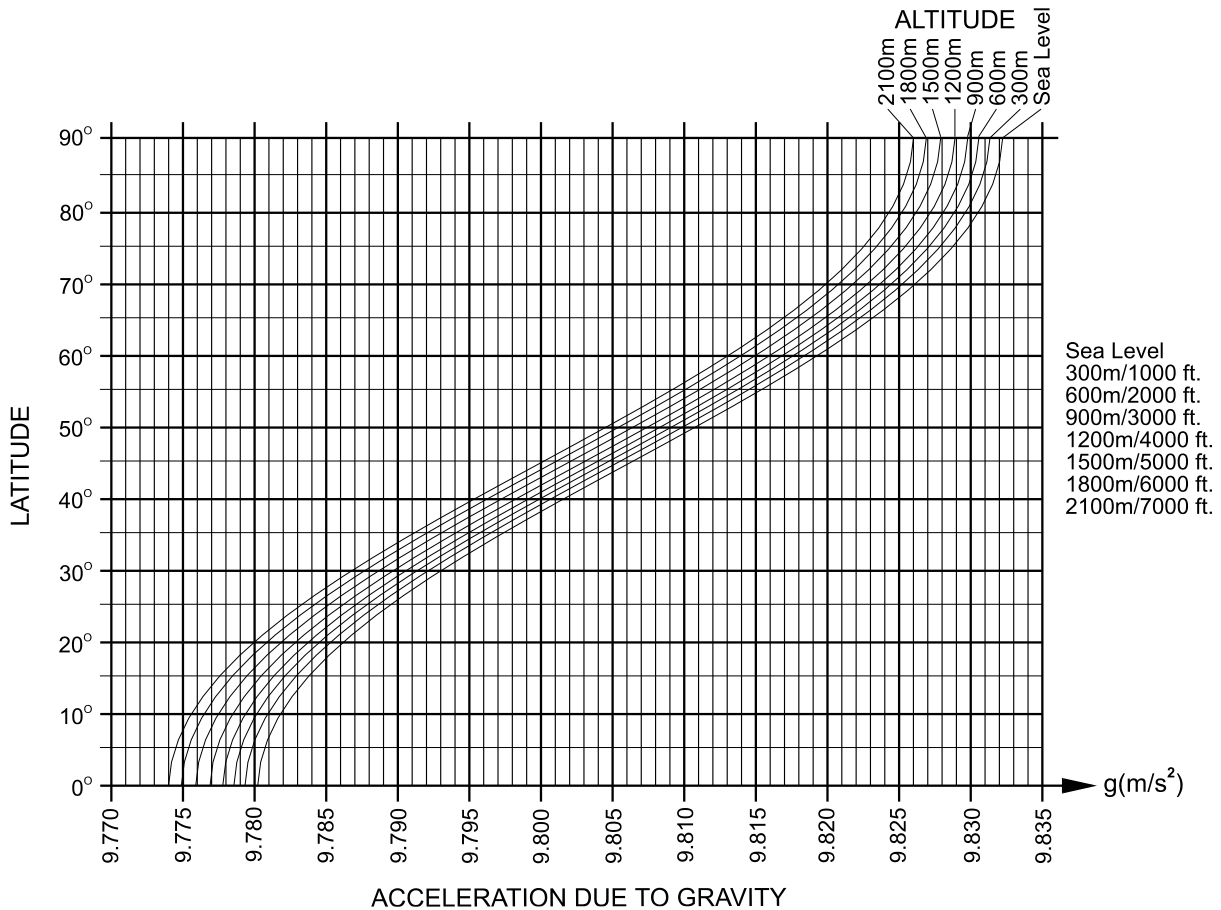

[Blank]



A&D Company, Limited

3-23-14 Higashi-Ikebukuro, Toshima-ku, Tokyo 170-0013, JAPAN
Telephone: [81] (3) 5391-6132 Fax: [81] (3) 5391-1566

A&D ENGINEERING, INC.

47747 Warm Springs Blvd, Fremont, California 94539, U.S.A.
Tel: [1] (800) 726-3364 Weighing Support:[1] (888) 726-5931 Inspection Support:[1] (855) 332-8815

A&D INSTRUMENTS LIMITED

Unit 24/26 Blacklands Way, Abingdon Business Park, Abingdon, Oxfordshire OX14 1DY United Kingdom
Telephone: [44] (1235) 550420 Fax: [44] (1235) 550485

A&D AUSTRALASIA PTY LTD

32 Dew Street, Thebarton, South Australia 5031, AUSTRALIA
Telephone: [61] (8) 8301-8100 Fax: [61] (8) 8352-7409

A&D KOREA Limited

한국에이.엔.디(주)
서울특별시 영등포구 국제금융로6길33 (여의도동) 맨하탄빌딩 817 우편 번호 07331
(817, Manhattan Bldg., 33. Gukjegeumyung-ro 6-gil, Yeongdeungpo-gu, Seoul, 07331 Korea)
전화: [82] (2) 780-4101 팩스: [82] (2) 782-4264

OOO A&D RUS

ООО "ЭЙ энд ДИ РУС"
Почтовый адрес:121357, Российская Федерация, г.Москва, ул. Верейская, дом 17
Юридический адрес: 117545, Российская Федерация, г. Москва, ул. Дорожная, д.3, корп.6, комн. 86
(121357, Russian Federation, Moscow, Vereyskaya Street 17)
тел.: [7] (495) 937-33-44 факс: [7] (495) 937-55-66

A&D Instruments India Private Limited

ऐ&डी इन्स्ट्रुमेन्ट्स इण्डिया प्रा० लिमिटेड
D-48, उद्योग विहार , फेस -5, गुडगांव - 122016, हरियाणा , भारत
(D-48, Udyog Vihar, Phase-V, Gurgaon - 122016, Haryana, India)
फोन : [91] (124) 4715555 फैक्स : [91] (124) 4715599

A&D SCIENTECH TAIWAN LIMITED. A&D台灣分公司 艾安得股份有限公司

台湾台北市中正區青島東路 5 號 4 樓
(4F No.5 Ching Tao East Road, Taipei Taiwan R.O.C.)
Tel : [886](02) 2322-4722 Fax : [886](02) 2392-1794

A&D INSTRUMENTS (THAILAND) LIMITED

บริษัท เอ แอนด์ ดี อินสตรูमेंท์ (ไทยแลนด์) จำกัด
168/16 หมู่ที่ 1 ตำบลรังสิต อำเภอธัญบุรี จังหวัดปทุมธานี 12110 ประเทศไทย
(168/16 Moo 1, Rangsit, Thanyaburi, Pathumthani 12110 Thailand)
Tel : [66] 20038911