

# A&D Digital Blood Pressure Monitor

## Model UA-651SLPlus

### Instruction Manual

Original  
1WMPD4003711C

## 1. Dear Customers

The A&D blood pressure monitor is one of the most advanced monitors available and is designed for ease of use and accuracy. This device will facilitate your daily blood pressure regimen.

- We recommend that you read through this manual carefully before using the device for the first time.

## 2. Preliminary Remarks

- This device conforms to the European Directive 93/42 EEC for Medical Products. This is made evident by the CE 0123 mark of conformity. (0123: The reference number to the involved notified body)
- The device is designed for use on adults, not newborns or infants.
- Environment for use. The device is for use to operate by yourself in the home healthcare environment.
- This device is designed to measure blood pressure and pulse rate of people for diagnosis.

## 3. Precautions

- Precision components are used in the construction of this device. Extremes in temperature, humidity, direct sunlight, shock or dust should be avoided.
- Clean the device and cuff with a dry, soft cloth or a cloth dampened with water and a neutral detergent. Never use alcohol, benzene, thinner or other harsh chemicals to clean the device or cuff.
- Avoid tightly folding the cuff or storing the hose tightly twisted for long periods, as such treatment may shorten the life of the components.
- Take care to avoid accidental strangulation of babies or infants with the hose and cable.
- Do not twist the air hose during measurement. This may cause injury due to continuous cuff pressure.
- The device and cuff are not water resistant. Prevent rain, sweat and water from soiling the device and cuff.
- Measurements may be distorted if the device is used close to televisions, microwave ovens, cellular telephones, X-ray or other devices with strong electrical fields.
- Wireless communication devices, such as home networking devices, mobile phones, cordless phones and their base stations, walkie-talkies can affect this blood pressure monitor. Therefore, a minimum distance of 30 cm should be kept from such devices.
- When reusing the device, confirm that the device is clean.
- Used equipment, parts and batteries are not treated as ordinary household waste, and must be disposed of according to the applicable local regulations.
- Do not modify the device. It may cause accidents or damage to the device.
- To measure blood pressure, the arm must be squeezed by the cuff hard enough to temporarily stop blood flow through the artery. This may cause pain, numbness or a temporary red mark to the arm. This condition will appear especially when measurement is repeated successively. Any pain, numbness, or red marks will disappear with time.
- Measuring blood pressure too frequently may cause harm due to blood flow interference. Check that the operation of the device does not result in prolonged impairment of blood circulation, when using the device repeatedly.
- Clinical testing has not been conducted on newborn infants and pregnant woman. Do not use on newborn infants or pregnant woman.
- If you have had a mastectomy, please consult a doctor before using the device.
- Do not let children use the device by themselves and do not use the device in a place within the reach of infants. It may cause accidents or damage.
- There are small parts that may cause a choking hazard if swallowed by mistake by infants.
- Do not touch the batteries, the DC jack, and the patient at the same time. That may result in electrical shock.
- Unplug the AC adapter when not in use during the measurement.
- Use of accessories not detailed in this manual may compromise safety.
- Should the battery short-circuit, it may become hot and potentially cause burns.
- Allow the device to adapt to the surrounding environment before use (about one hour).
- Do not inflate without wrapping the cuff around the upper arm.

## Contraindications

- The following are precautions for proper use of the device.
- Do not apply the cuff on an arm with another medical electrical equipment attached. The equipment may not function properly.
  - People who have a severe circulatory deficit in the arm must consult a doctor before using the device, to avoid medical problems.
  - Do not self-diagnose the measurement results and start treatment by yourself. Always consult your doctor for evaluation of the results and treatment.
  - Do not apply the cuff on an arm with an unhealed wound.
  - Do not apply the cuff on an arm receiving an intravenous drip or blood transfusion. It may cause injury or accidents.
  - Do not use the device where flammable gases such as anesthetic gases are present. It may cause an explosion.
  - Do not use the device in highly concentrated oxygen environments, such as a high-pressure oxygen chamber or an oxygen tent. It may cause a fire or explosion.

## 4. Parts Identification

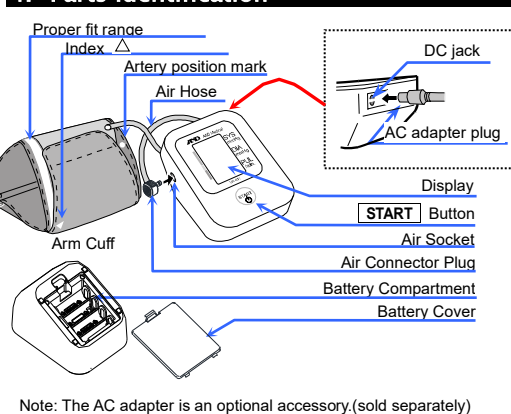

MEMORY	Function / Meaning
000	SYS Systolic Pressure
000	DIA Diastolic Pressure
000	PUL Pulse Rate
000	I.H.B./AFib symbol
000	Heart Mark
000	Battery Indicator
000	Pressure Bar Indicator and WHO Classification Indicator

## 5. Symbols

### Symbols that appear on the display

Symbols	Function / Meaning	Recommended Action
♥	Appears while measurement is in progress. It blinks when the pulse is detected.	Measurement is in progress. Remain as still as possible.
♥	I.H.B./AFib symbol appears when an irregular heartbeat is detected. It may light when a very slight vibration like shivering or shaking is detected.	
M	Previous measurements stored in memory.	
Full Battery Icon	FULL BATTERY The battery power indicator during measurement.	
Low Battery Icon	LOW BATTERY The battery power is low when it blinks.	Replace all batteries with new ones when the mark blinks.
Err E	Device internal error	Remove the batteries and press the [START] button, and then install the batteries again. If the error still appears, contact the dealer.

Err	Unstable blood pressure due to movement during measurement.	Take another measurement. Remain still during measurement.
Err	The systolic and diastolic values are within 10 mmHg of each other.	
Err	The pressure value did not increase during the inflation.	Apply the cuff correctly, and take another measurement.
Err	The cuff is not applied correctly.	
E	PUL DISPLAY ERROR The pulse is not detected correctly.	

### Symbols printed on the device case.

Symbols	Function / Meaning
Standby and Turn the device on.	
SYS	Systolic blood pressure in mmHg
DIA	Diastolic blood pressure in mmHg
PUL/min	Pulse per minute
Battery Installation Guide	
Direct current	
Type BF: Device, cuff and tubing are designed to provide special protection against electrical shocks.	
EC 0123	EC directive medical device label
EU-representative	
Manufacturer	
2019	Date of manufacture
WEEE label	
SN	Serial number
Refer to instruction manual/booklet	
Polarity of DC jack	
IP	International protection symbol
Keep dry	

## 6. Using the Monitor

### 6.1. Installing / Changing The Batteries

- Remove the battery cover.
- Remove the used batteries from the battery compartment in case of changing them.
- Insert new batteries into the battery compartment as shown, taking care that the polarities (+) and (-) are correct.
- Replace the battery cover. Use only R6P, LR6 or AA batteries.

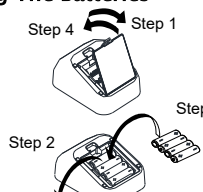

### CAUTION

- Insert the batteries as shown in the battery compartment. If installed incorrectly, the device will not work.
- When the battery cover blinks on the display and the device announces that the battery needs to be replaced, replace all batteries with new ones. Do not mix old and new batteries. It may shorten the battery life, or cause the device to malfunction. Replace the batteries two seconds or more after the device turns off.
- The battery does not appear when the batteries are drained.
- The battery life varies with the ambient temperature and may be shorter at low temperatures.
- Generally, four new R6P batteries will last approximately for three months when used twice for measurement each day.
- Use the specified batteries only. The batteries provided with the device are for testing the device performance and may have a limited life.
- Remove the batteries if the device is not to be used for a long time. The batteries may leak and cause a malfunction.

### 6.2. Connecting The Air Hose

- Insert the air connector plug into the air socket firmly.

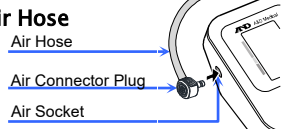

### 6.3. Connecting The AC Adapter

- Insert the AC adapter plug into the DC jack. Then, insert the AC adapter into an electrical outlet. The AC adapter, the model TB-233C is sold separately.
- When disconnecting the AC adapter from the electrical outlet, grasp and pull the AC adapter body out of the outlet.
- When disconnecting the AC adapter plug from the blood pressure monitor, grasp and pull the AC adapter plug out of the monitor.

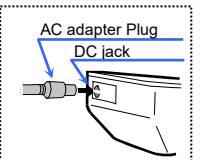

### 6.4. Selecting The Correct Cuff

- Using the correct cuff size is important for an accurate reading. If the cuff is not the proper size, the reading may yield an incorrect blood pressure value.
- The arm size is printed on each cuff.
- The index Δ and proper fit range, on the cuff, tell you if you are applying the correct cuff. Refer to "6.5 Applying The Arm Cuff".
- If the index Δ points outside of the range, contact your local dealer to purchase a replacement cuff.
- The arm cuff is a consumable. If it becomes worn, purchase a new one.

Arm Size	Recommended Cuff Size	Catalog Number
31 cm to 45 cm	Large adult cuff	CUF-D-LA-ISO
22 cm to 42 cm	Wide range cuff	CUF-I-ISO
23 cm to 37 cm	Semi large cuff	CUF-D-MA-ISO
22 cm to 32 cm	Adult cuff	CUF-D-A-ISO
16 cm to 24 cm	Small adult cuff	CUF-D-SA-ISO

Arm size: The circumference at the biceps.

### Symbols printed on the cuff.

Symbols	Function / Meaning	Recommended Action
Artery Position Mark	Set the ○ mark on the artery of the upper arm or in line with the ring finger on the inside of the arm.	
Index		
REF	Catalog number	
L	Proper fit range for the large adult cuff. It's printed on the large adult cuff.	
W	Proper fit range for the wide range cuff. It's printed on the wide range cuff.	
M	Proper fit range for the semi large cuff. It's printed on the semi large cuff.	
A	Proper fit range for the adult cuff. It's printed on the adult cuff.	
S	Proper fit range for the small cuff. It's printed on the small cuff.	
L	Over range printed on the adult cuff/semi large cuff/wide range cuff.	Use the large adult cuff instead of the adult cuff / semi large cuff / wide range cuff.
S	Under range printed on the adult cuff/semi large cuff/wide range cuff.	Use the small cuff instead of the adult cuff / semi large cuff / wide range cuff.
M/A	Over range printed on the small cuff.	Use the adult cuff / semi large cuff instead of the small cuff.
M	Under range printed on the large adult cuff.	Use the semi large cuff instead of the large adult cuff.
LOT	Lot number	

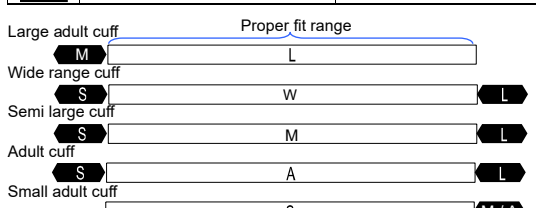

### 6.5. Applying The Arm Cuff

- Wrap the cuff around the upper arm, about 1 to 2 cm above the inside of the elbow, as shown. Place the cuff directly against the skin, as clothing may cause a faint pulse and result in a measurement error.
  - Constriction of the upper arm, caused by rolling up a shirtsleeve, may prevent accurate readings.
  - Confirm that the index Δ points within the proper fit range.
- Note: During measurement, it is normal for the cuff to feel very tight. (Do not be alarmed).

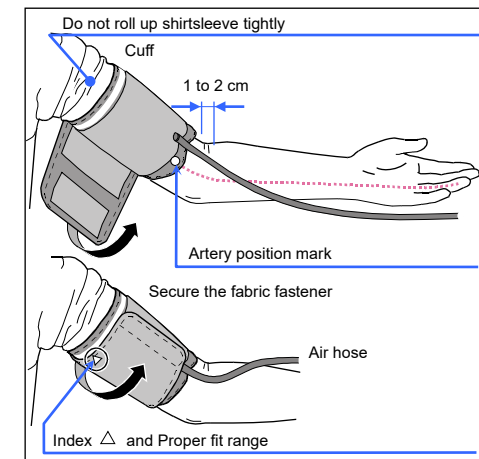

## 7. Measurements

### 7.1. Normal Measurement

- Place the cuff on the arm at heart level (preferably the left arm). Sit quietly during measurement.
- Press the [START] button. All of the display segments are displayed. Zero is displayed blinking briefly. Then the display changes, as indicated in the figure at the right, as the measurement begins. The cuff starts to inflate. It is normal for the cuff to feel very tight. A pressure bar indicator is displayed, as in the figure at the right, during inflation.

Note: If you wish to stop inflation at any time, press the [START] button again.

- When inflation is complete, deflation starts automatically and the ♥ (heart mark) blinks, indicating that the measurement is in progress. Once the pulse is detected, the mark blinks with each pulse beat.
- When the measurement is complete, the systolic and diastolic pressure readings and pulse rate are displayed. The cuff exhausts the remaining air and deflates completely.

- Press the [START] button again to turn off the power. The device is provided with an automatic power shut-off function. Allow at least 3 minutes between measurements on the same person.

### 7.2. Measurement with the Desired Systolic Pressure

- If re-inflation occurs repeatedly, use the following methods. If your systolic pressure is expected to exceed 230 mmHg, use this procedure.

- Place the cuff on the arm at heart level (preferably the left arm).
- Press the [START] button.
- During the zero blinks, press and hold the [START] button until a number about 30 to 40 mmHg higher than your expected systolic pressure appears.
- When the desired number is reached, release the [START] button to start measurement. Then continue to measure your blood pressure as described on the section "7.1 Normal Measurement".

### 7.3. Notes for Accurate Measurement

- Sit comfortably on a chair. Rest your arm on the table. Do not cross your legs. Keep your feet on the floor and straighten your back.
- Sit down in a comfortable position. Place your arm on a table with your palm facing upward and the cuff at the same level as your heart.
- Place the center of the cuff at the same level as your heart.
- Relax for about five to ten minutes before measurement. If you are excited or depressed by emotional stress, the measurement will reflect this stress as a higher (or lower) than normal blood pressure reading and the pulse reading will usually be faster than normal.
- Remain still and keep quiet during measurement.
- Do not measure immediately after physical exercise or a bath. Rest for twenty or thirty minutes before taking the measurement.
- An individual's blood pressure varies constantly, depending on what you are doing and what you have eaten. What you drink can have a very strong and rapid effect on your blood pressure.
- This device bases its measurements on the heartbeat. If you have a very weak or irregular heartbeat, the device may have difficulty determining your blood pressure.
- Should the device detect a condition that is abnormal, it will stop the measurement and display an error symbol. Refer to the section "5 Symbols" for the description of the symbols.
- This device is intended for use by adults. Consult with your physician before using this device on a child. A child should not use this device unattended.
- Try to measure your blood pressure at the same time every day.
- The automatic blood pressure monitor's performance may be affected by excessive temperature or humidity, or altitude.

## 8. Recalling the Memory Data

The device automatically stores up to sixty blood pressure and pulse measurements in memory. Data stored in memory are assigned a data number in the order of the newest to the oldest. The oldest data displays as "n0". The M symbol in the upper left corner of the display indicates that you are viewing previous data stored in memory.

### 8.1. Recalling Data

- When nothing is displayed, press and hold the [START] button to recall the stored data.
- Release the button when displaying the average data.
- The data number and stored data are automatically displayed in order from the last measurement.
- The display will turn off automatically after all data is displayed.

Note: If you press the [START] button while recalling data, the device turns off.

### 8.2. Clearing Data

- When turning off the device, press and hold the [START] button until the "Lr n0" is displayed.
- Select "Lr YES" to clear data.
- Data is cleared when the M mark blinks.
- The device turns off automatically.

## 9. What is the I.H.B./AFib

When the monitor detects an irregular rhythm during the measurements, the I.H.B./AFib indicator will appear on the display with the measurement values.

Note: We recommend contacting your physician if you see this I.H.B./AFib symbol frequently.

## 10. What is AFib

The heart contracts due to electrical signals occurring in heart and sends blood through the body. Atrial fibrillation (AFib) occurs when the electrical signal in the atrium becomes confused and leads to disturbances in the pulse interval. AFib can cause blood to stagnate in the heart, which can easily create clots of blood, a cause of stroke and heart attack.

## 11. Pressure Bar Indicator

The indicator monitors the progress of pressure during measurement.

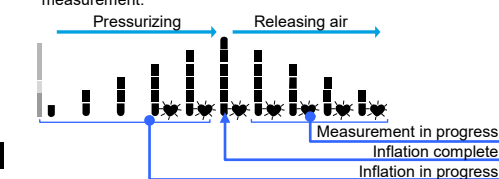

## 12. About Blood Pressure

### What is Blood Pressure?

Blood pressure is the force exerted by blood against the walls of the arteries. Systolic pressure occurs when the heart contracts. Diastolic pressure occurs when the heart expands. Blood pressure is measured in millimeters of mercury (mmHg). One's natural blood pressure is represented by the fundamental pressure, which is measured first thing in the morning while one is still at rest and before eating.

### 13. WHO Classification Indicator

Each segment of the bar indicator corresponds to the WHO blood pressure classification.

WHO Classification Indicator	Indicator
Severe hypertension	Severe hypertension
Moderate hypertension	Moderate hypertension
Mild hypertension	Mild hypertension
High normal	High normal
Normal	Normal
Optimal	Optimal

### 14. Troubleshooting

Problem	Possible Reason	Recommended Action
Nothing appears on the display, even when the power is turned on.	Batteries are drained. Battery terminals are not in the correct position.	Replace all batteries with new ones. Reinstall the batteries with negative and positive terminals matching those indicated on the battery compartment.
The cuff does not inflate.	Battery voltage is too low. The batteries are drained completely, the mark does not appear.	Replace all batteries with new ones.
The device does not measure. Readings are too high or too low.	The cuff is not applied properly.	Apply the cuff correctly.
	You moved your arm or body during measurement. The cuff position is not correct.	Make sure you remain still and quiet during measurement. Sit comfortably and still. Place your arm on a table with your palm facing upward and the cuff at the same level as your heart.
Other	If you have a very weak or irregular heartbeat, the device may have difficulty in determining your blood pressure.	At a clinic or doctor's office, an apprehension may cause an elevated reading. Home measurement reduces the effects of outside influences on blood pressure readings, supplements the doctor's readings.
	The value is different from that measured at a clinic or doctor's office.	Remove the batteries. Place them back properly and take another measurement.

Note: If the actions described above do not solve the problem, contact the dealer. Do not attempt to open or repair this product, as any attempt to do so will make your warranty invalid.

## 15. Maintenance

Do not open the device. It uses delicate electrical components and an intricate air unit that could be damaged. If you cannot fix the problem using the troubleshooting instructions, contact the authorized dealer in your area or our customer service department. The A&D customer service will provide technical information, spare parts and units to authorized dealers.

The device was designed and manufactured for a long service life. However it is generally recommended to have the device inspected every 2 years, to ensure proper functioning and accuracy. Please contact the authorized dealer in your area or A&D for maintenance.

## 16. Technical Data

Type	UA-651SLPlus
Measurement method	Oscillometric measurement
Measurement range	Pressure: 0 - 299 mmHg
	Systolic pressure: 60 - 279 mmHg
	Diastolic pressure: 40 - 200 mmHg
	Pulse: 40 - 180 beats / minute
Measurement accuracy	Pressure: ±3 mmHg
	Pulse: ±5 %
Power supply	4 x 1.5V batteries (R6P, LR6 or AA)
	Optional AC adapter (TB-233C) (Not included)
Number of measurements	Approx. 700 times
	Approx. 200 times
Classification	Class II device
	Class II device
Clinical test	With pressure value 180 mmHg, room temperature 23 °C.
	Internally powered ME equipment (Supplied by batteries) / Class II (Supplied by adapter)
EMD	Continuous operation mode
	According to ISO81060-2 : 2013
Memory	In the clinical validation study, K5 was used on 85 subjects for determination of diastolic blood pressure.
	IEC 60601-1-2: 2014
Operating conditions	Last 60 measurements
	+10 to +40 °C / 15 to 85 %RH / 800 to 1060 hPa
Transport / Storage conditions	-20 to +60 °C / 10 to 95 %RH / 700 to 1060 hPa
	Approx. 96 [W] x 68 [H] x 130 [D] mm
Dimensions	Approx. 240 g, excluding the batteries
	Device: IP20
Weight	Cuff: Type BF(A)
	Device: 5 years (when used six times a day)
Ingress protection	Cuff: 2 years (when used six times a day)
	AC adapter: 5 years (when used six times a day)
Applied part	AC adapter: 5 years (when used six times a day)
	Accessory AC adapter/TB233C

The adapter is to connect the device to a power source at home. Please contact your local A&D dealer for purchasing. The AC adapter is required to be inspected or replaced periodically.

Symbols	Function / Meaning
↑	For indoor use only
□	Class II device
⊞	Thermal fuse
⊞	Fuse
CE	EC directive device label
⊞	EAC certification device label
⊞	Polarity of AC adapter plug

Accessories sold separately	Cuff Size	Arm Size
Cuff	CUFF-D-LA-ISO	Large adult cuff
	CUFF-I-ISO	Wide range cuff
	CUFF-D-MA-ISO	Semi large cuff
	CUFF-D-A-ISO	Adult cuff
	CUFF-D-SA-ISO	Small adult cuff

AC Adapter	Catalog Number	Plug (Outlet type)
	TB-233C	Type C

Note: Specifications are subject to change without prior notice. IP classification is the degrees of protection provided by enclosures in accordance with IEC 60529. This device is protected against solid foreign objects of 12 mm diameter and greater such as a finger. This device is not protected against water.