

TM-2441

Recorder for Ambulatory Blood
Pressure Monitor

INSTRUCTION MANUAL

Ambulatory Blood Pressure Monitor

© 2017 A&D Company, Limited. All rights reserved.

- No part of this publication may be reproduced, transmitted, transcribed, or translated into any language in any form by any means without the written permission of A&D Company, Limited.
- The contents of this manual and the specifications for the instrument covered by this manual are subject to change for improvement without notice.
- The *Bluetooth*® word mark and logos are registered trademarks owned by *Bluetooth* SIG, Inc. and any use of such marks by A&D is under license.
- Other trademarks and trade names are those of their respective owners.

Compliance

Compliance with European Directive

The device conforms to Medical Devices Directive 93/42/EEC.

This is shown by the CE mark of conformity accompanied by the reference number of a designated authority.

The device conforms to RoHS Directive 2011/65/EU.

The device conforms to Radio Equipment Directive 2014/53/EU.

Hereby, A&D Company, Limited declares that the device is in compliance with Radio Equipment Directive 2014/53/EU.

The full text of the EU declaration is available at the following internet address: https://www.aandd.jp/products/manual/manual_medical.html

Compliance with FCC Rules

This device complies with Part 15 of the FCC Rules. Operation is subject to the following two conditions: (1) This device may not cause harmful interference and (2) this device must accept any interference received, including interference that may cause undesired operation. (FCC = Federal Communications Commission in the U.S.A.)

FCC CAUTION

Changes or modifications not expressly approved by the party responsible for compliance could void the user's authority to operate the equipment. This transmitter must not be co-located or operated in conjunction with any other antenna or transmitter. This equipment complies with FCC radiation exposure limits set forth for an uncontrolled environment and meets the FCC radio frequency (RF) Exposure Guidelines. This equipment has very low levels of RF energy that it deemed to comply without testing the specific absorption ratio (SAR).

Compliance with IC Rules

This device complies with Industry Canada license-exempt RSS standard(s). Operation is subject to the following two conditions: (1) this device may not cause interference and (2) this device must accept any interference, including interference that may cause undesired operation of the device.

This equipment complies with IC radiation exposure limits set forth for an uncontrolled environment and meets RSS-102 of the IC radio frequency (RF) Exposure rules. This equipment has very low levels of RF energy that are deemed to comply without testing the specific absorption ratio (SAR).

Compliance with the Australian EMD Framework

The device conforms to the following requirements:

EMD Emission standard for industrial, Scientific & Medical equipment AS/ NZS 2064:1997, EMD Generic Immunity standard AS/NZS 4252.1:1994. The above is shown by the C-Tick label.

Bluetooth[®] Transmission

This device is equipped with a *Bluetooth* wireless function and can connect to the *Bluetooth* device that is *Bluetooth* wireless technology enabled medical devices.

Applications and devices that are compatible with *Bluetooth* 4.1.



Each device needs an application to receive data.

Warning Definitions







To prevent accidents due to inappropriate handling, this product and its manual contain the following warning signs and marks.

The meanings of these warning signs and marks are as follows.

Warning Definitions

 Danger	An imminently hazardous situation that will result in death or serious injury, if not avoided.
 Warning	A potentially hazardous situation that could result in death or serious injury, if not avoided.
 Caution	A potentially hazardous situation that may result in minor or moderate injury, if not avoided. It may also be used to warn against unsafe practice.

Symbol Examples

	The symbol  indicates "Caution". The nature of the caution required is described inside or near the symbol, using text or a picture. The example indicates caution against electrical shock.
	The symbol  indicates "Do not". The prohibited action is described inside or near the symbol, using text or a picture. The example indicates "Do not disassemble".
	The symbol  indicates mandatory action. The mandatory action is described inside or near the symbol, using text or a picture. The example indicates general mandatory action.

Other



Note	Provides information useful for the user when operating the device.
-------------	---



Precautions for each operation are described in the pages of this manual. Read the instruction manual before using the device.

Precautions for Use

In order to use the TM-2441 (the recorder for the ambulatory blood pressure monitor) safely and correctly, read the following precautions carefully before using the monitor. The following content summarizes general matters affecting the safety of patients and operators, as well as safe handling of the monitor. Precautions for each operation are described in the pages of this manual. Read the instruction manual before using the device.

1. Precautions When Wearing and Storing the Recorder.

 Danger	
	<p>Keep the recorder away from areas where flammable anesthetics or flammable gases are present, high-pressure oxygen chambers and oxygen tents. Using the recorder in these areas may cause an explosion.</p> <p>Do not use the recorder together with a magnetic resonance imaging system (MRI).</p>

 Caution	
	<p>To preserve the capabilities of the device, consider the following environmental conditions when using and storing the recorder. The performance of the recorder may be affected by excessive temperature, humidity and altitude.</p> <ul style="list-style-type: none">□ Avoid locations where the recorder may be splashed by water.□ Avoid locations with high temperature, high humidity, direct sunlight, dust, salt and sulfur in the air.□ Avoid locations where the recorder may be tilted, vibrated, or impacted (including during transportation).□ Avoid locations where chemicals are stored or gas is present.

Caution



- Operation conditions:
Temperature : +10 °C to +40 °C,
Humidity: 30 %RH to 85 %RH (no condensation).
- Transport and storage conditions:
Temperature: -20 °C to +60 °C,
Humidity: 10 %RH to 95 %RH (no condensation).

2. Precautions Before Using the Recorder.

Caution



- Confirm that the recorder is operating safely and correctly.
- When the recorder is used in conjunction with other devices, it may cause an incorrect diagnosis or safety problems.
Confirm that the devices can be connected safely.
- Check for mutual interference with other medical devices.
Confirm that the recorder can be used correctly.
- Use accessories, options and consumables specified by A&D.
- Carefully read the instruction manuals provided with optional items. Any cautions and warnings are not described in this manual.
- For safe and correct use of the recorder, inspect it before use.
- Leave the recorder in a normal operation state for one hour or more before use and turn it on.



- Only connect **dedicated peripherals** to the USB connector.
Do not connect other devices.
- Do not connect any cuff except for a cuff authorized by A&D to the air socket.

Preparation of the Recorder

- Delete the last data stored in the recorder before it is used by the next patient.
- Replace the batteries before the recorder is used by the next patient.

Device

- Use the recorder for diagnosis and countermeasures only.
- Confirm that the air hose and cuff are worn correctly. (Example: kinks and tension in the air hose, position and direction of the cuff)

Instructions for the Patient Wearing the Device



- Inform the patient how to turn the **AUTO** switch "OFF" to stop the recorder if a problem occurs when alone.
- Inform the patient to remove the recorder quickly when in pain or if any problem occurs.
- Take care when using around babies and infants, as there is a danger of accidental suffocation with the air hose.

3. Precautions for Batteries Used for Blood Pressure Measurement.

Caution

- Install the batteries in accordance with polarity signs "+" and "-" shown on the inside of the battery cover. (Note the polarities)
- Replace flat batteries with new ones at the same time.
- Remove the batteries if the recorder is not going to be used for a long period of time. The battery may leak and cause a malfunction.
-  □ Use two alkaline batteries (size AA) or specified re-chargeable batteries (size AA, Ni-MH).
- Push and hold the "-" spring terminal with the battery. Slide and install the "+" terminal of the battery at the "+" terminal of the battery compartment. If the battery is installed from the "+" terminal, the battery cover may be damaged.

Caution



- | | |
|---|---|
|  | <ul style="list-style-type: none">□ Do not touch the battery and the patient at the same time. It may cause an electric shock. |
|  | <ul style="list-style-type: none">□ Do not mix old batteries with new ones. Do not use batteries of different type and manufacturer. If these are used, this may cause leakage, heat and explosion. The recorder may malfunction. |

4. Precautions During Use.

Danger

- | | |
|---|--|
|  | <ul style="list-style-type: none">□ Do not use the recorder while operating automobiles or other vehicles.
Example: The recorder may inhibit the motion of the body or arms when operating the vehicle. etc. |
|---|--|

Warning

- | | |
|---|---|
|  | <ul style="list-style-type: none">□ This medical device can be only operated by a doctor or a legally authorized person. Explain the correct usage to the patient and ensure they can stop measurement when a problem occurs. |
|  | <ul style="list-style-type: none">□ Do not use a mobile phone near the recorder (less than 30 cm). It may cause a malfunction. |

Caution

- | | |
|---|--|
|  | <ul style="list-style-type: none">□ Stop using the recorder and switch the AUTO switch to "OFF", if the patient feels pain in their arm or the measurement is incorrect.□ Do not use the recorder in a strong magnetic or electric field.□ Do not use the recorder on a patient using a heart-lung machine. |
|---|--|

Note

Instructions for Patient

If the temperature is low, battery power becomes lower and the measurement count is reduced.

5. Precautions After Using the Recorder.

Caution

Processing work of Measurement Data

- Be sure to process measurement data immediately using a **dedicated peripheral**.

The Recorder

- After cleaning the accessories, arrange and store them.
- Clean the recorder for the next measurement.
- Switch the **AUTO** switch to "**OFF**". If you leave the **AUTO** switch at "**ON**", pressurization for automatic measurement is started at the next measurement start time and the cuff or other parts may be broken by the inflation.
- Remove the batteries from the recorder if it is not going to be used for a long period of time. The batteries may leak and break the recorder.
- Avoid having a child use the recorder on their own. Do not put the recorder in a place within reach of an infant. Doing so may cause accidents or damage.



Hold the connector housing when connecting and removing the cable. Do not pull on the cable.

Note



Precautions After Using the Recorder (TM-2441)

- Be sure to process measurement data immediately using a **dedicated peripheral** after finishing measurement.

Backup Lithium Rechargeable Battery

- The recorder comes with a backup lithium battery. This battery supplies power to the built-in clock when replacing AA batteries used for blood pressure measurement. The lithium battery is charged from the AA batteries.

How to Extend the Life of the Backup Battery

- When first using after purchase or after storing for a month or more, replace the batteries and charge the backup battery. It is enough if the backup battery is charged for 48 hours or more. (The backup battery is always charged by the AA batteries.)
- Replace with two new AA batteries when the battery indicator displays .
- When  is displayed on the battery indicator, the blood pressure measurement and data communication cannot be performed. Replace with two new AA batteries.
- Remove the batteries to prevent the recorder from liquid leakage from a battery if the recorder is not used for a month or more.

6. Remedies When the Device Has an Error

Warning



- Stop the operation and remove the AA batteries. If the battery terminals are shorted, the battery may be hot.
- In the event of a failure, the recorder may get hot during measurement, please handle it with care.
- Put the "**Malfunction**" "**Do not use**" notice label on the recorder. Contact your dealer.
- Stop the recorder immediately when the measurement time is above 180 seconds and the air pressure rises above 299 mmHg.

7. Precautions for Maintenance

Warning



- Confirm the correct performance and safety of the recorder when it has not been used for a long period of time.
- To maintain correct measurement and safety, perform an inspection and maintenance before use. The user (hospital, clinic, etc.) is responsible for the management of the medical equipment. If the inspection and maintenance are not performed correctly, an accident may occur.

Caution



- Use a dry lint free cloth to clean the recorder.
Do not use volatile agents, such as a thinner or benzine.
Do not use a wet cloth.



- Do not disassemble or modify the recorder (medical electronic device). It may cause damage.

8. Precautions and Remedies for a Malfunction Due to a Strong Electromagnetic Field

Caution



- The recorder complies with EMD-standard IEC60601-1-2: 2014 + A1: 2020. However, to prevent electromagnetic interference with other devices, do not use mobile phones near the recorder.
- If the recorder is located near strong electromagnetic fields, noise may affect the waveforms and malfunctions may occur. If an unexpected malfunction occurs during use, check for electromagnetic interference and take appropriate actions.
- Do not use a *Bluetooth* connection within the range of a wireless LAN or other wireless devices, near devices that emit radio waves such as microwaves, in locations where there are many obstructions, or in other locations where signal strength is weak. Doing so may result in frequent loss of connection, very slow communication speeds and errors.

Caution



The following examples are general causes of malfunctions and their remedies.

- Use of mobile phones
Radio waves may cause unexpected malfunctions.
 - Wireless communication devices, home networking devices such as cordless phones and similar communication devices can affect the recorder. Therefore, they must be kept at a distance of at least 30 cm or more from the recorder.

 **Caution**



- If there is static electricity in the area of use (discharges from devices or the surrounding area)
 - Before using the recorder, ensure that the operator and patient have discharged any static electricity.
 - Humidify the room.
- Use close to an IEEE802.11g/b/n wireless LAN device may cause mutual interference to occur, which may result in reduced communication speeds or prevent connection. In this case, switch off the power supply to the device that is not being used, or use the monitor in a different location.

9. Environmental Protection

 **Caution**



Before disposing of the recorder, remove the lithium battery from the recorder.

Precautions For Safe Measurement

This section describes precautions for measurement and the sensor. Notify the patient of following content and explain it to them. Guide the patient in the correct use of the device.

Blood Pressure Measurement

Warning



Ensure the tube is not bent excessively and that air flows properly. If a bent air hose is used, air pressure may remain in the cuff, which may stop blood flow to the arm.



Do not measure the blood pressure on an arm if the patient has the following conditions. This may cause an accident or aggravation of the injury.

- 1) An injury or disease on an arm.
- 2) An arm receiving an intravenous drip or blood transfusion.
- 3) A limb that is shunted for artificial dialysis.
- 4) The patient has been bedridden for a long time (Where there is a possibility of thrombus).

Caution



- Confirm the condition of the patient if there are measurement problems. The device guesses that the condition is worsening beyond the limit of measurement or if the air flow ceases because the air hose is bent.
- Measuring blood pressure too frequently may cause bodily harm due to blood flow interference. Confirm that the operation of the device does not result in prolonged impairment on blood circulation, when using the device repeatedly.
- Blood pressure measurement may not be accurate if the patient has continuous arrhythmia, or moves excessively.

Caution



- Wear the cuff at the same level as heart. (If the level is different, an error in the measurement value occurs.)
- The recorder responds to artifact and external impact. If there are any doubts in the measurement value, measure blood pressure by auscultation or palpation.
- A measurement error may occur if the cuff is not of the correct arm circumference for the patient.



- Do not inflate the cuff before it is wrapped around the arm of the patient. Damage and explosion of the cuff may occur.

Note

- Blood pressure measurement may cause subcutaneous bleeding. This subcutaneous bleeding is temporary and disappears with time.
- If the patient uses a heart-lung machine, blood pressure cannot be measured due to the absence of a heartbeat.
- Blood pressure cannot be measured correctly if thick clothing is worn.
- Blood pressure cannot be measured correctly if the clothing is rolled up and the arm is squeezed.
- Blood pressure cannot be measured correctly if peripheral circulation is insufficient, the blood pressure is excessively low or if the patient has hypothermia (blood flow is insufficient).
- Blood pressure cannot be measured correctly if the patient has frequent arrhythmia.
- Blood pressure cannot be measured correctly with the incorrect cuff size.
- Blood pressure cannot be measured correctly if the cuff is not worn at the same level as the heart.

Note

- Blood pressure cannot be measured correctly if the patient is moving or talking during measurement.
- Clinical trials have not been conducted on newborn infants and pregnant women.
- Consult a doctor before use if you have had a mastectomy.

Cuff

Warning



- Dispose of cuffs contaminated by blood to prevent infectious disease from spreading.
- Avoid storing the cuff folded or with a tightly twisted air hose for extended periods of time. Such treatment may shorten the life of the components.

Measurement of Pulse Rate

Warning



Do not use the displayed pulse rate for the diagnosis of an irregular heartbeat.

Note

The recorder measures the pulse rate when measuring the blood pressure.

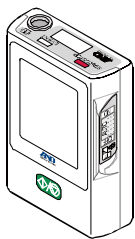

Blood pressure Recorder

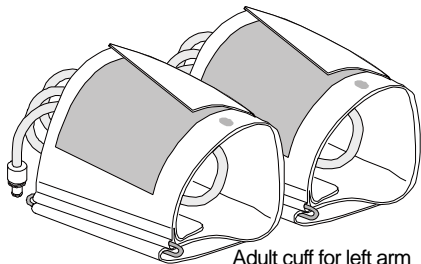

Adult cuff for left arm
Large cuff for left arm

Carry holder

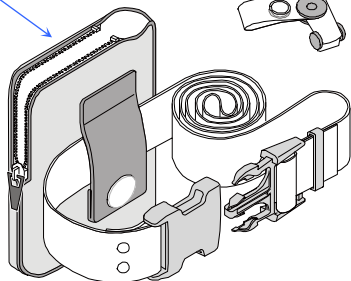

Clip

Belt

Adult cuff cover
Large cuff cover

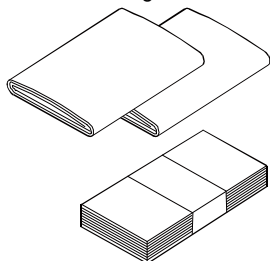

Activity record sheet (10 sheets)

ABPM Data Manager CD



USB cable

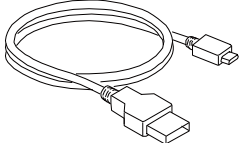

This instruction manual

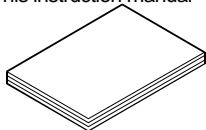

Contents

Compliance	i
Compliance with European Directive.....	i
Compliance with FCC Rules.....	i
Compliance with IC Rules.....	ii
Compliance with the Australian EMD Framework	ii
<i>Bluetooth</i> [®] Transmission.....	ii
Warning Definitions.....	iii
Precautions for Use	iv
Precautions For Safe Measurement.....	xiii
Blood Pressure Measurement	xiii
Cuff	xv
Measurement of Pulse Rate	xv
Packing List.....	xvi
1. Introduction	5
2. Features.....	5
3. Abbreviations & Symbols	8
4. Specifications	13
4.1. Recorder	13
4.2. Dimensions	16
5. Component Names.....	17
5.1. Recorder	17
5.2. Display	18
5.2.1. LCD Panel (Liquid crystal display).....	18
5.2.2. OLED Display (Organic light emitting diode).....	19

5.3.	Principal Switch Operations.....	20
5.3.1.	A-BPM Operations.....	20
5.3.2.	S-BPM Operations.....	23
5.3.3.	Other Operations	25
6.	Blood Pressure Measurement Functions.....	27
6.1.	Automatic Blood Pressure Measurement (A-BPM).....	27
6.1.1.	A-BPM Waiting Mode	29
6.1.2.	Sleep Function and Interval time	29
6.1.3.	Stopping Measurement.....	30
6.1.4.	Storing Environment Data.....	30
6.2.	Self Blood Pressure Measurement (S-BPM).....	31
6.2.1.	S-BPM Programs	32
6.2.2.	S-BPM Waiting Mode	36
6.2.3.	Stopping and Suspending Measurement	37
6.3.	Measurement Results.....	38
6.3.1.	Displaying Measurement Results.....	38
6.3.2.	Storing Measurement Results	38
6.3.3.	Outputting Measurement Results	39
6.3.4.	ID Numbers	39
7.	Preparing the Recorder	40
7.1.	Installing the Batteries (Replacing Batteries)	40
7.1.1.	How to Replace Batteries	42
7.2.	Preparing the Carry Holder.....	42
7.3.	Inspection for Use.....	43
7.3.1.	Battery Pre-installation Checklists	43
7.3.2.	Battery Post-installation Checklists	44

8.	Operation	45
8.1.	Operation Flowchart	45
8.2.	Initial Settings	47
8.2.1.	Factory Settings	47
8.2.2.	The Clock and the Monitor Function of Measurement	48
8.2.3.	Initial Pressurization Value of S-BPM.....	50
8.3.	A-BPM Preset Programs	50
8.3.1.	A-BPM Items and Parameters.....	52
8.3.2.	A-BPM Program Examples.....	55
8.3.3.	Start Time and Operation Time	57
8.4.	S-BPM Programs.....	58
8.4.1.	S-BPM Items and Parameters.....	59
8.4.2.	S-BPM Display Examples.....	60
8.5.	Deleting Measurement Data.....	63
8.6.	Attaching the Product to the Patient.....	64
8.6.1.	Information for Patients.....	64
8.6.2.	Cuff Cover	66
8.6.3.	Attaching the Cuff, Carry holder and Recorder	67
8.7.	Blood Pressure Measurement Operations.....	70
8.7.1.	A-BPM Operations.....	70
8.7.2.	S-BPM Operations.....	72
8.7.3.	Manual Measurement.....	74
8.7.4.	Stopping and Suspending Measurements	75
8.8.	Connecting the Recorder to a Dedicated Peripheral	77
8.8.1.	Connecting with a USB cable	77
8.8.2.	Using <i>Bluetooth</i> [®] Communication.....	79
8.8.3.	Suspending <i>Bluetooth</i> [®] Communication (Airplane mode).....	80

9.	Maintenance	81
9.1.	Product Storage, Inspection and Safety Management	81
9.2.	Cleaning the Product	82
9.3.	Periodic Inspection	84
9.3.1.	Battery Pre-installation Inspection	84
9.3.2.	Battery Post-installation Inspection	85
9.4.	Disposal	86
9.5.	Troubleshooting	87
9.6.	Error Codes	88
10.	Optional Items (requiring order)	91
11.	Appendix	93
11.1.	Principle of Blood Pressure Measurement	93
11.2.	EMD Information	96

1. Introduction

Thank you for your Purchase!

The TM-2441 ambulatory blood pressure recorder enables accurate measurement of patient blood pressure automatically for preset times (e.g. 24-hours continuously). This manual explains the settings, operation, modes and programs for blood pressure measurement, as well as communication with a **dedicated peripheral**, maintenance, specifications and warnings. Read this manual for proper use and keep it in an accessible place.

2. Features

Summary

The recorder is an ambulatory blood pressure monitor that can non-invasively measure the blood pressure value and pulse rate of the patient under the guidance of a doctor. The purpose is to measure and store variation of the blood pressure over a day during daily life. The recorder is designed to be portable and have a data management function and simple operation.

Blood pressure measurement target

This recorder is designed for adults (above 12 years of age).

Purpose of use

The recorder is equipped with two modes for blood pressure measurement. Blood pressure values can be used for consulting with doctors and self-health management.

Automatic blood pressure measurement (A-BPM)

This mode can specify six pairs of arbitrary start times and intervals for every 24 hours and can automatically measure and record blood pressure.

Self-blood pressure measurement (S-BPM)

The use of this mode assumes that a patient measures their own blood pressure at home or in hospital. This mode can use five types of programs in accordance depending on use.

Portability

The weight of the recorder is approximately 135 g (excluding batteries).

It is palm sized and equipped with a micro-pump.

Two AA alkaline batteries can be used. (LR6 or AA size)

Two rechargeable batteries (AA size, Ni-MH battery) can be used.

Operability

The settings of the recorder and the blood pressure measurement program can be configured easily using the ABPM Data Manager installed on the computer (**dedicated peripheral**).

Extensive analytical performance

The measurement interval time can be set for the automatic blood pressure measurement.

The blood pressure can be measured immediately using manual measurement at any time.

S-BPM is equipped with five programs for varying conditions.

The analysis can be carried out effectively using the ABPM Data Manager installed on the computer (**dedicated peripheral**).

Shorter measurement time

The deflation speed is controlled to minimize the measurement time.













The pressurization value is controlled to minimize the measurement time.







Simple convenience

A **dedicated peripheral** can receive data over a USB cable.

Data received data can be analyzed and printed easily.

3. Abbreviations & Symbols

Symbols	Meaning
SYS	Systolic blood pressure
DIA	Diastolic blood pressure
PUL	Pulse rate
PP	Pulse pressure $PP = SYS - DIA$
kPa mmHg	Unit of blood pressure
/min	Unit of pulse rate/minute
	Mark indicating heartbeat during measurement.
	<i>Bluetooth</i> is being used.
	Displaying: A-BPM is in operation. Blinking: Interval time of " 1 scope " is performed.
" 	The IHB (Irregular Heart Beat) indicator.
	Mute
	Memory full, delete data to start measurement.
	Battery indicator If the level 1  is displayed, blood pressure measurement and data communication cannot take place. Replace the batteries with 2 new LR6 (AA size) batteries.
	A-BPM sleep mark
	The mark is displayed during configuration.
---	Out of range or impossible measurement value.
E _{xx}	Error codes. $xx = 00$ to 99
	S-BPM START mark
	S-BPM STOP mark
LCD	Liquid crystal display
OLED	Organic light emitting diode
	Alert mark

Symbols	Meaning
	Degree of protection against electric shock: Equipment type BF.
	Manufacturer of the CE Marking. Date of manufacture.
SMALL	Symbol for small cuff Arm circumference 15 to 22 cm 5.9" to 8.7"
ADULT	Symbol for adult cuff Arm circumference 20 to 31 cm 7.8" to 12.2"
LARGE	Symbol for large cuff Arm circumference 28 to 38 cm 11.0" to 15.0"
EXTLARGE	Symbol for extra-large cuff Arm circumference 36 to 50 cm 14.2" to 19.7"
Large cuff 28-38cm 11"-15"	Symbol printed on packing. Large cuff is included in accessories.
Adult cuff 20-31cm 7.8"-12.2"	Symbol printed on packing. The adult cuff is included in the accessories.
	Refer to the instruction manual or booklet.
	Symbol for "Keep dry" and "Keep away from rain".
SN	Serial number
	Symbol printed in the battery compartment. Direction (polarity) to install battery.
x2 1.5V LR6 1.2V HR6 not included	Symbol printed on packing. Batteries are excluded from accessories.
EMD	Electromagnetic disturbances
	Symbol for "Handle with care".
	The symbol for waste electrical and electronic equipment directive.

Symbols	Meaning
BPM	Blood pressure measurement
A-BPM	Automatic blood pressure measurement
S-BPM	Self-blood pressure measurement
Sleep, Cycle, Hour, START, Operation	A-BPM symbols. #1
OBP, AOBP, HBP, ANBP, ASBP	S-BPM symbols. #2
Pairing, Flight Mode	<i>Bluetooth</i> symbols. #3
Not made with natural rubber latex.	Caution for patient. This is printed on the cuff.
<div style="border: 1px solid black; padding: 5px;"> <p>⚠ Caution</p> <ul style="list-style-type: none"> • Use alkaline batteries or specified rechargeable batteries and ensure correct polarity (+, -). • Do not mix new, used or different branded batteries. • Firmly secure cuff air hose to main body. </div>	<p>⚠ Cautions on battery cover.</p> <ul style="list-style-type: none"> □ Use alkaline batteries or the rechargeable batteries specified and ensure correct polarity (+, -). □ Do not mix new, used or different branded batteries. □ Firmly secure cuff air hose to main body.

- #1:** Refer to "**6.1. Automatic Blood Pressure Measurement (A-BPM)**" and "**8.3. A-BPM Preset Programs**" for 24-hours blood pressure recorder.
- #2:** Refer to "**6.2. Self Blood Pressure Measurement (S-BPM)**" and "**8.4. S-BPM Programs**" for five types of programs.
- #3:** Refer to "**8.8.2. Using *Bluetooth*[®] Communication**" and "**8.8.3. Suspending *Bluetooth*[®] Communication (Airplane mode)**".

IHB indicator

When the monitor detects an irregular rhythm during measurement, the IHB indicator “” will appear on the display with the measurement values. (S-BPM only)

1 scope

“1 scope” in S-BPM consists of a set of blood pressure measurements and interval times which are repeated for the number of the measurement count. The last interval time is omitted.

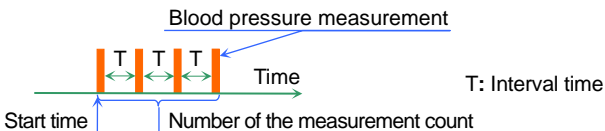

Waiting mode

The A-BPM **waiting mode** is a state where the blood pressure is not being measured during the **interval time**.

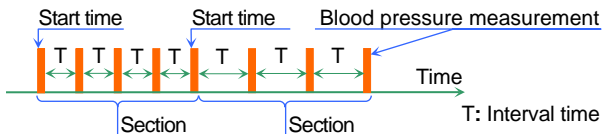

The S-BPM **waiting mode** is a state when the blood pressure is not being measured during the interval time and between the previous "1 scope" and next "1 scope".

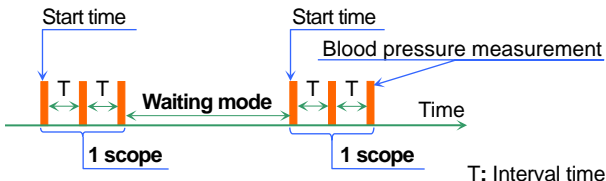

Dedicated peripheral

A **dedicated peripheral** means the computer on which the ABPM Data Manager is installed. The ABPM Data Manager is stored on an accessory CD.



Use a peripheral device that complies with the requirements for medical electrical equipment (IEC60601-1) when connecting the recorder to a peripheral device. Do not connect the recorder to another devices (Example: IEC60950) in an area where medical equipment is used. Use a USB cable shorter than 1.5 m (4.9 ft).

4. Specifications

4.1. Recorder

Items	Descriptions
Measurement method	Oscillometric measurement method
Pressure detection method	Semiconductor pressure sensor
Pressure display range	0 to 299 mmHg
Measurement accuracy	Pressure: ± 3 mmHg Pulse rate: ± 5 %
Minimum display division	Pressure: 1 mmHg Pulse rate: 1 beat/minute
Measurement range	Systolic pressure: 60 to 280 mmHg Diastolic pressure: 30 to 160 mmHg Pulse rate: 30 to 200 beats/minute
Depressurization	Constant exhaust with a controlled leakage valve for safety
Exhaust	Electromagnetic valve
Pressurization method	Micro-pump
Automatic pressurization	85 to 299 mmHg
Interval time (of A-BPM)	Intervals at each section which divides 24 hours into six parts at the maximum. Interval: OFF, 5, 10, 15, 20, 30, 60, 120 minutes
Clock	24 hour clock
Display	A-BPM: OLED, 96 x 39 pixels, white characters S-BPM: LCD, 40 x 50 mm, Display: systolic pressure, diastolic pressure, pulse rate, clock, error, status monitor and symbols

Items	Descriptions
Memory	Measurement data: 600 data points max.
Power supply	With the same type of batteries: <ul style="list-style-type: none"> □ 2 x 1.5V batteries (LR6 or AA size) □ Alkaline battery or nickel-hydrate battery (Ni-MH) 1900 mAh or more Backup battery for built-in clock: Lithium rechargeable coin cell battery ML2016H
Measurement count	200 times or more. (when new alkaline batteries or nickel-hydrate batteries are used. It may vary due to measurement conditions.)
Rated voltage	DC 3.0 V (Alkaline battery, LR6), DC 2.4 V (Nickel-hydrogen battery, AA size)
Interface	<ul style="list-style-type: none"> □ USB: USB1.1 compliant. Cable length: 1.5 m or shorter. Micro-USB B type terminal can connect to dedicated peripheral (using standard driver software). □ <i>Bluetooth</i> Ver.4.1 (BLE): Wireless device can be connected.
Operating condition	Temperature: +10 to +40 °C Humidity: 30 to 85 %RH (no condensation)
Transport and storage conditions	Temperature: -20 to +60 °C Humidity: 10 to 95 %RH (no condensation)
Atmospheric pressure both for operation and storage condition	700 to 1060 hPa
Type of protection against electric shock	Internally powered equipment

Items	Descriptions
Degree of protection against electric shock 	Type BF: The recorder, cuff and tubing are designed to provide special protection against electrical shock.
CE Marking  0123	The EC directive label for medical device.
C-Tick Marking	The certification trademark registered to the ACA by the Trademark office.
Dimensions	Approx. 95 (L) × 66 (W) × 24.5 (H) mm
Mass	Approx. 135 g (excluding batteries)
Useful life	Recorder: 5 years. Self-authentication with internal data. Proper operation and maintenance in the best conditions. Durability varies with usage conditions.
Ingress protection	Device: IP22
Default mode	Continuous measurement
Restart time after defibrillation	Immediately
EMD	IEC 60601-1-2: 2014 +A1: 2020
Wireless communication	LBCA2HNZYZ (MURATA Manufacturing Co. Ltd) <i>Bluetooth</i> Ver.4.1 BLP Frequency range: 2.4GH (2400 to 2483.5 MHz) Modulation: GFSK Effective radiated power: < 20 dBm

Note:

- # Specifications are subject to change for improvement without prior notice.
- # Clinical trial for this device is performed in based on ISO 81060-2:2013.
- # The recorder is not medical device for monitoring patient. We don't recommend the way of use that has to monitor patient in real time at place like intensive care unit.

ACA: Australian communications authority

4.2. Dimensions

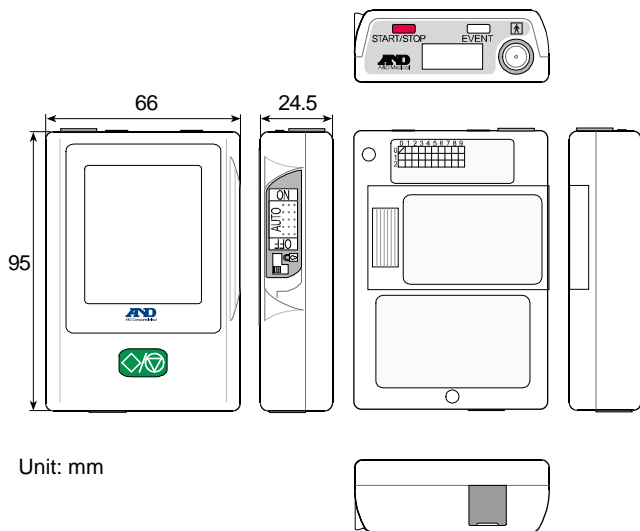

5. Component Names

5.1. Recorder

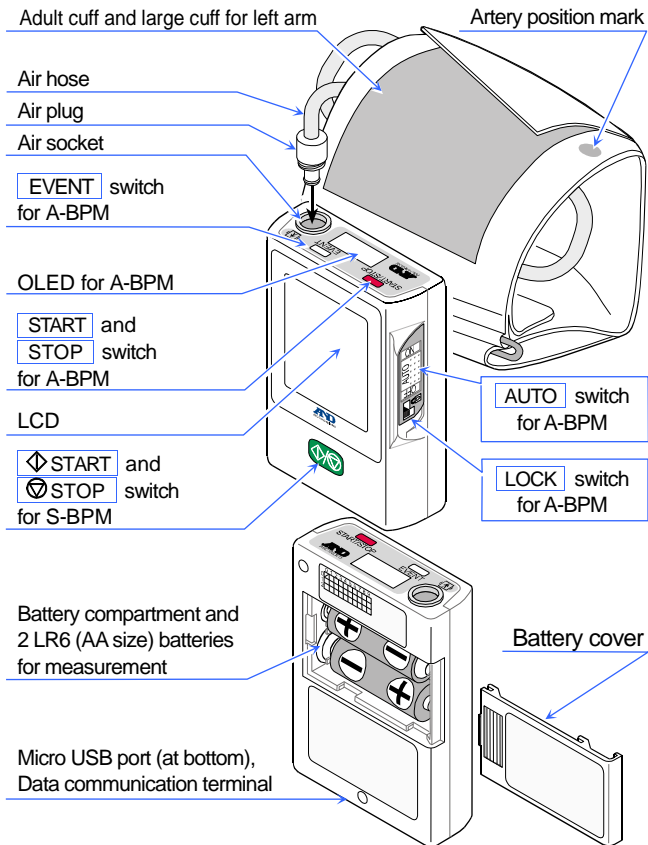

5.2. Display

Note

- To get accurate diagnosis, take care to accurately read the data displayed on the recorder and interpret it properly.

5.2.1. LCD Panel (Liquid crystal display)

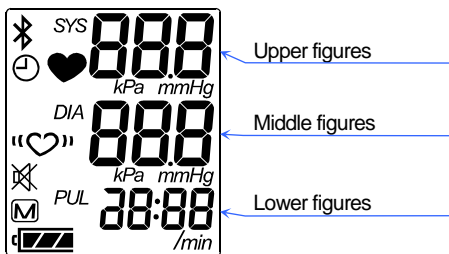

The following values can be displayed in each mode:

	Measurement Result	A-BPM	S-BPM
Upper figures	Systolic blood pressure	Interval time	Program
Middle figures	Diastolic blood pressure	Remaining time	Pressure value
Lower figures	Pulse	Time of clock	Time of clock

Refer to "[3.Abbreviations & Symbols](#)" for the meanings of symbols on the LCD.

5.2.2. OLED Display (Organic light emitting diode)

The state of A-BPM is indicated on the OLED.

Clock time.

The state of settings and operation.

The measurement value of A-BPM.



SYS Systolic blood pressure.

DIA Diastolic blood pressure.

PUL Pulse rate.

mmHg Unit for blood pressure value.

/min Unit for the pulse rate.

Refer to "[3.Abbreviations & Symbols](#)" for the meanings of symbols on the OLED.

Symbols	Meaning
	The mark is displayed during configuration.
	Displaying: A-BPM is performing. Blinking: Interval time of "1 scope" is performing.
	<i>Bluetooth</i> is being used.
	Memory full
	A-BPM sleep mark
	Battery indicator

5.3. Principal Switch Operations

5.3.1. A-BPM Operations

To start or suspend A-BPM.

To switch between A-BPM and S-BPM

Step 1. Store the preset program (of start times and intervals) for A-BPM.

Step 2. Set the **AUTO** switch for the following operations.

"ON" A-BPM is started and the \oplus mark is shown.

Blood pressure measurements are performed in accordance with the preset A-BPM program.

"OFF" A-BPM is suspended and the \ominus mark is hidden.

Blood pressure measurement can be performed using the preset S-BPM programs.

To lock A-BPM to "ON".

Keep the **AUTO** switch to "ON" using the **LOCK** switch so that A-BPM can be performed.

To expand A-BPM interval time.

Step 1. Set the sleep mode to "ON" before measurement.

Step 2. Set the **AUTO** switch to "ON" to use A-BPM.

The \oplus mark is shown.

Step 3. When the **EVENT** switch is pressed during A-BPM, the interval time is doubled.

When the **EVENT** switch is pressed again, the interval time returns to basic value.

To stop during A-BPM

When the **START/STOP** switch is pressed during blood pressure measurement, the air is expelled immediately and the current measurement is stopped. However, A-BPM is continued. The next blood pressure measurement is performed in accordance with A-BPM settings.

To set the program for A-BPM.

- Step 1. Set the **AUTO** switch to "OFF".
- Step 2. If the display is hidden, press the **START/STOP** or **EVENT** switch to return to the waiting mode display.
- Step 3. While pressing and holding the **START/STOP** switch, press and hold the **EVENT** switch until **Sleep** is displayed on the OLED.
- Step 4. The operation switches are as follows:

Refer to "[8.3.1.A-BPM Items and Parameters](#)"

- | | |
|--------------------------------|---------------------------------------|
| EVENT switch | Change the current parameter. |
| START/STOP switch | Decision, next item, end of settings. |

To measure blood pressure during A-BPM immediately. (Manual blood pressure measurement of A-BPM)

- Step 1. If the OLED is hidden, press the **START/STOP** or **EVENT** switch to return to the A-BPM waiting mode display. The A-BPM **waiting mode** is a state when blood pressure is not measured during the **interval time**.
- Step 2. Press the **START/STOP** switch during the A-BPM waiting mode.

To adjust the clock.

To set the monitor function of A-BPM.

- Step 1. Set the **AUTO** switch to "OFF".
- Step 2. If the display is hidden, press the **START/STOP** or **EVENT** switch to return to the waiting mode display.
- Step 3. While pressing and holding the **START/STOP** switch, press and hold the **EVENT** switch until **Display** (after **Sleep**) is displayed on the OLED.
- Step 4. Operation switches are as follows:

Refer to "**8.2.2.The Clock and the Monitor Function of Measurement**"

EVENT switchChange the current parameter.

START/STOP switchDecision, next item, end of settings.

5.3.2. S-BPM Operations

To start S-BPM.

Step 1. Select the S-BPM program and store its parameters.

Step 2. Set the AUTO switch to "OFF".

Step 3. Operations are as follows:

S-BPM Programs		Operations
Office blood pressure	OBP	Press the ◀/▶ switch to start the preset program during waiting mode.
Automated office blood pressure	AOBP	
Home blood pressure	HBP	
Automated night blood pressure	ANBP	Preset program enters standby until the "start time" or "start time of alarm".
Automated self-blood pressure	ASBP	

To stop S-BPM.

Operations are as follows:

S-BPM Programs	Operations
Office blood pressure OBP	Press the ◀/▶ switch to stop blood pressure measurement.
Automated office blood pressure AOBP	
Home blood pressure HBP	
Automated night blood pressure ANBP	Press the ◀/▶ switch to stop blood pressure measurement. At the next start time, the blood pressure is measured or the buzzer sounds. #1
Automated self-blood pressure ASBP	If you need to stop the recorder completely, remove the batteries from the recorder or switch to OBP, AOBP, or HBP.

#1: Refer to "6.2.1.S-BPM Programs".

To set the program for S-BPM.

- Step 1. Set the **AUTO** switch to "OFF".
- Step 2. While pressing and holding the **↔/⊗** switch, press and hold the **START/STOP** switch until **SEL** is displayed on the LCD.
- Step 3. The operations are as follows:
Refer to "**8.4.S-BPM Programs**".
- ↔/⊗** switchChange the current parameter.
START/STOP switchDecision, next item, end of settings.

To measure the blood pressure during S-BPM immediately. (Manual blood pressure measurement of S-BPM)

- Step 1. If the LCD is hidden, press the **START/STOP** or **EVENT** switch to return to the S-BPM waiting mode display.
- Step 2. Press the **↔/⊗** switch during the S-BPM waiting mode.
The blood pressure measurements for "**1 scope**" are performed immediately.
- "**1 scope**" consists of a set of blood pressure measurements and interval times which are repeated for the number times in the measurement count. The last interval time is omitted.
- The S-BPM **waiting mode** is a state when blood pressure is not measured during the interval time and between the last "**1 scope**" and next "**1 scope**".

5.3.3. Other Operations

To return from the waiting mode and show the monitor.

If the OLED or LCD display is hidden, press the

START/STOP or **EVENT** switch to return to the waiting mode display.

Deleting measurement data

Step 1. Set the **AUTO** switch to "OFF".

Step 2. If the indication is hidden, press the **START/STOP** or **EVENT** switch to return to the waiting mode display.

Step 3. While pressing and holding the **START/STOP** switch, press and hold the **EVENT** switch until **DataClear** (after **Sleep** and **Display**) is displayed on the OLED.

Step 4. Select an operation.

- If you wish to delete data, press and hold the **START/STOP** switch.

Erasing blinks under **DataClear** on the OLED and the deletion of data starts.

Proceed to step 5 after deletion.

Step 4. Deleting
OLED **DataClear**
Erasing

- If you keep (do not delete) data, press the **EVENT** switch and proceed to step 5.

Step 5. The recorder returns to waiting mode.

To pair for *Bluetooth*[®] communication.

- Step 1. Set the **AUTO** switch to "OFF".
- Step 2. If the display is hidden, press the **START/STOP** or **EVENT** switch to return to the waiting mode display.
- Step 3. Press and hold the **EVENT** switch until **Pairing** (after **FlightMode**) is displayed on the OLED. The recorder starts waiting for pairing.
- Step 4. When *Bluetooth* pairing is complete, the ✂ mark is displayed on the LCD.
- If you cancel the current pairing, press the **EVENT** switch. The recorder proceeds to the waiting mode display.

To suspend *Bluetooth*[®] communication. (Airplane mode)

- Step 1. Set the **AUTO** switch to "OFF".
- Step 2. If the display is hidden, press the **START/STOP** or **EVENT** switch to return to the waiting mode display.
- Step 3. Press and hold the **EVENT** switch until **FlightMode** is displayed on the OLED.
- Step 4. Airplane mode can be turned on/off using the **START/STOP** switch.



- Step 5. Press the **EVENT** switch to return to the waiting mode display.

6. Blood Pressure Measurement Functions

The recorder is equipped with automatic blood pressure measurement (A-BPM) and self-blood pressure measurement (S-BPM) and can store measurement states and measurement results.

6.1. Automatic Blood Pressure Measurement (A-BPM)

⚠ Caution



- When A-BPM is suspended or is not used, set the **AUTO** switch to "OFF". If the **AUTO** switch is left "ON", the measurement will start at the next start time and the cuff may burst.
- Use the **LOCK** switch to prevent the **AUTO** switch from moving to "OFF" accidentally while A-BPM is used.

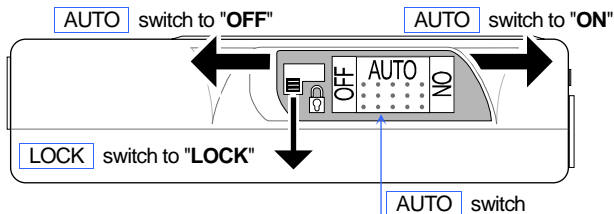

The A-BPM function measures the blood pressure at preset intervals using the built-in clock and stores the measurement result in the memory.

A-BPM can be started and suspended with the **AUTO** switch. Use the **LOCK** switch to prevent it from moving accidentally while A-BPM is used.

The  mark is displayed on the LCD while A-BPM is used. Blood pressure is measured automatically at A-BPM start time.

An initial pressurization value of A-BPM is AUTO, so that a proper pressurization value is selected automatically.

If the first pressurization is insufficient, re-pressurizations are performed automatically up to two times.

When you delete data from the memory or move the AUTO switch to "OFF", the pressurization value is reset to the initial pressurization value.

When a measurement error occurs and the waiting time until the next start time is longer than 8 minutes, blood pressure is measured once after 120 seconds. The measurement result is stored in the memory.

If you want to suspend A-BPM, release the LOCK switch and move the AUTO switch to "OFF".

6.1.1. A-BPM Waiting Mode

Items to monitor the measurement state can be displayed on the LCD during the waiting time for A-BPM.

In the waiting mode, the indicators are hidden automatically. Press any switch to show the display items.

The A-BPM **waiting mode** is a state when blood pressure is not measured during the interval time.

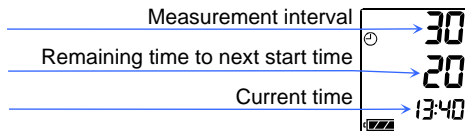

6.1.2. Sleep Function and Interval time

Set the sleep mode to "ON" in the preset program.

When the **EVENT** switch is pressed during A-BPM, the interval time doubles.

When the **EVENT** switch is pressed again in A-BPM, the interval time returns to its original length.

Refer to "[8.3.A-BPM Preset Programs](#)" for information on how to set the sleep mode.

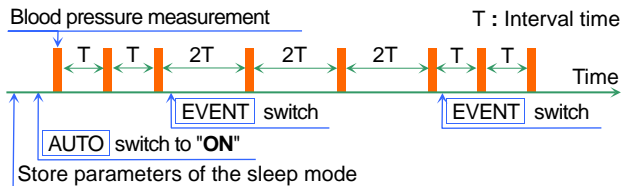

6.1.3. Stopping Measurement

When the **START/STOP** switch is pressed during the blood pressure measurement, the air is expelled immediately and the current measurement is stopped. However, A-BPM is continued. The next blood pressure measurement is performed in accordance with A-BPM settings.

Note

When measurement is stopped, the stop code **E07** is displayed on the OLED and is stored in the memory.

6.1.4. Storing Environment Data

The environment data is stored while the **AUTO** switch is set to "ON" for A-BPM.

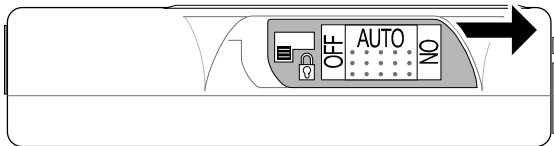

Note

- The environment data can be store for 12 hours at most. Its download to the ABPM Data Manager may take 50 minutes.

6.2. Self Blood Pressure Measurement (S-BPM)

Set the AUTO switch to "OFF" to use S-BPM programs.

The recorder is equipped with five types of S-BPM programs in accordance with varying measurement environment conditions.

Parameters and measurement results can be stored in the memory.

Name	Descriptions & actions of the program	Items
OBP <i>obp</i>	Office blood pressure Program for blood pressure measurement by hospital staff. " 1 scope ": Blood pressure measurement occurs once.	N.A.
AOBP <i>Rob</i>	Automated office blood pressure Program for blood pressure measurement after resting inside the hospital. " 1 scope ": Measurement is performed using the measurement count and interval time.	Count Interval
HBP <i>hbp</i>	Home blood pressure #1 Program for blood pressure measurement at home. " 1 scope ": Measurement is performed using the measurement count and interval time.	Count Interval
ANBP <i>Anb</i>	Automated night blood pressure #2 Program for blood pressure measurement at night. It uses the measurement count and interval time. The ANBP can specify up to six start times a day.	Start time Count Interval
ASBP <i>Asb</i>	Automated self-blood pressure #2 Program that indicates start times with sound from the buzzer. Press the ◀/▶ switch to measure the blood pressure at home. The buzzer can specify up to six times a day.	Start time of alarm Count Interval

#1: Blood pressure is measured in accordance with the Japanese Society of Hypertension guidelines.

#2: When the measurement count and interval time for ANBP or ASBP are changed, HBP settings are also changed.

6.2.1. S-BPM Programs

Office blood pressure

OBP *obP*

When the  switch is pressed, blood pressure is measured once and is stored in the memory.

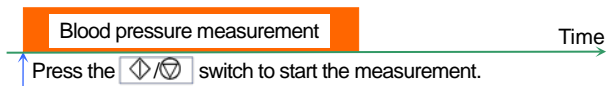

Automated office blood pressure

AOBP *AobP*

When the  switch is pressed, AOBP is started.

First, the device is idle for the interval time to allow the patient to relax. Next, the AOBP performs a "1 scope".

"1 scope" consists of a set of blood pressure measurements and interval times, which are repeated for the number of times of the measurement count. The last interval time is omitted.

When the  switch is pressed during the "1 scope", the "1 scope" is stopped.

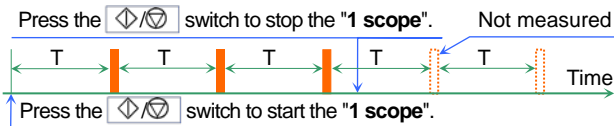
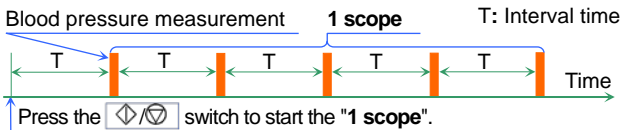

Home blood pressure

HBP *hbP*

When the  switch is pressed, HBP is started.

The HBP performs a "1 scope".

"1 scope" consists of a set of blood pressure measurements and interval times which are repeated to the number of the measurement count. The last interval time is omitted.

When the  switch is pressed during the "1 scope", the "1 scope" is stopped.

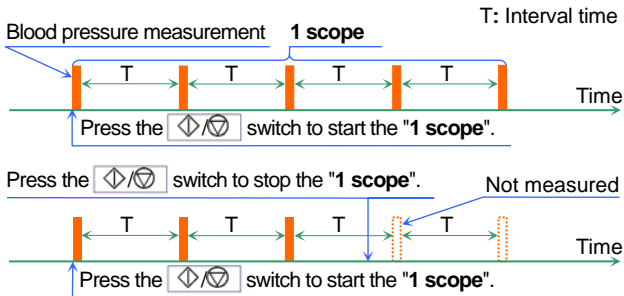

Automated night blood pressure

ANBP *Rnb*

The ANBP can specify up to six preset **start time** a day.

When parameters for the ANBP program are stored, the ANBP is started and a "**1 scope**" is performed for each **start time**.

A "**1 scope**" consists of a set of blood pressure measurements and interval times which are repeated to the number of the measurement count. The last interval time is omitted.

Note

Manual blood pressure measurement of the ANBP

When the  switch is pressed in S-BPM waiting mode, a "**1 scope**" is performed.

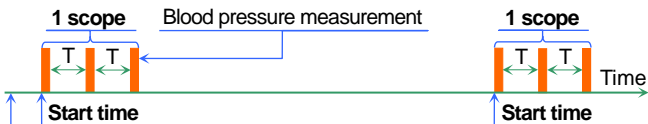

The ANBP is started at the same time when ANBP program is set.
(The ANBP becomes waiting mode until **start time**)

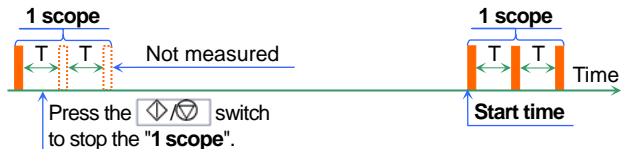
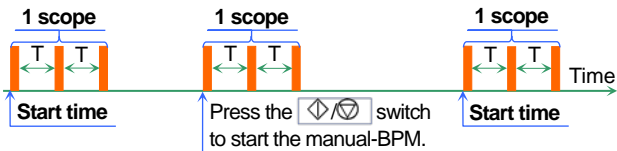

T: Interval time

Automated self-blood pressure

ASBP *RSb*

The ASBP can specify up to six preset **start time** for the alarm. When parameters for the ASBP program are stored, the ASBP is started and the buzzer sounds at each **start time**. Press the  switch to perform a "1 scope" when the buzzer sounds. "1 scope" consists of a set of blood pressure measurements and interval times, which are repeated up to the number of times of the measurement count. The last interval time is omitted.

Note

Manual blood pressure measurement for the ASBP

When the  switch is pressed in waiting mode between the last "1 scope" and the next "1 scope", The "1 scope" is performed.

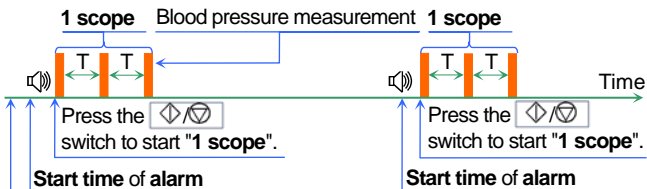

The ASBP is started at the same time when ASBP program is set.
(The ASBP becomes waiting mode until **start time**)

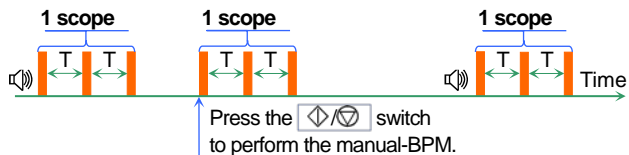

T: Interval time

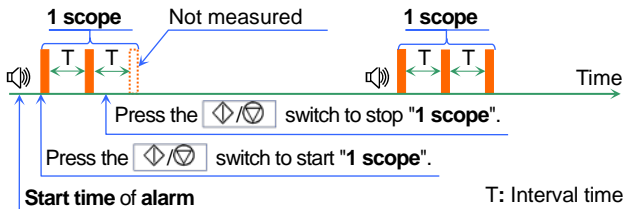

6.2.2. S-BPM Waiting Mode

Operation mode and pressure value are displayed on the LCD during S-BPM waiting mode.

- # The LCD will be hidden automatically after no-operation is continued for few minutes. Even if the LCD is hidden, the manual blood pressure measurement can be started when the [START/STOP] switch is pressed. When the [START/STOP] or [EVENT] switch is pressed, the display resumes.

A "1 scope" consists of a set of blood pressure measurements and interval times which are repeated up to the number of times of the measurement count. The last interval time is omitted.

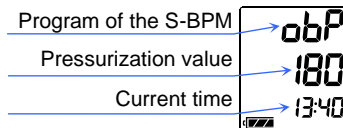

Clock mark  blinks on the LCD during a "1 scope" interval time. The S-BPM **waiting mode** is a state when blood pressure is not being measured during the "interval time" and between the last "1 scope" and next "1 scope".



6.2.3. Stopping and Suspending Measurement

Note

When A-BPM is stopped, the stop code **E07** is displayed on the LCD and is stored in the memory.

S-BPM Programs	Operations
Office blood pressure OBP	Press the  switch to stop blood pressure measurement.
Automated office blood pressure AOBP	
Home blood pressure HBP	
Automated night blood pressure ANBP	Press the  switch to stop blood pressure measurement. At the next start time, blood pressure is measured or the buzzer sounds. #1
Automated self- blood pressure ASBP	If you need to stop the recorder completely, remove the batteries from the recorder or switch to OBP, AOBP, or HBP.

#1: Refer to "[6.2.1.S-BPM Programs](#)".

6.3. Measurement Results

6.3.1. Displaying Measurement Results

The monitor function can select "**Display ON**" or "**Display OFF**" for the A-BPM measurement result. This function cannot be used for S-BPM. The content of the "**Display ON**" command includes "Pressure value during the measurement", "Measurement result" and "Error code for the measurement result".

When "**Display OFF**" is selected, the clock is displayed.

The factory setting is set to "**Display ON**".

Refer to "[8.2.2.The Clock and the Monitor Function of Measurement](#)".

6.3.2. Storing Measurement Results

Caution



Data processing of the measurement result

Do not use in a strong electromagnetic field.

The memory capacity for the measurement result is 600 data sets.

When the memory is full, the  mark is displayed and the recorder cannot perform measurement until data is deleted from the memory.

Note

Delete data from the memory before giving the recorder to a new patient. We recommend using the memory data of the recorder for each person separately. If the recorder memorizes data for multiple people, data may be difficult to process correctly.

6.3.3. Outputting Measurement Results

The measurement data stored in the memory can be output to the peripheral using USB data transfer.

Refer to "[8.8.Connecting the Recorder to a Dedicated Peripheral](#)".

Caution



- Do not remove the cable while using USB communication. It may cause damage to the data.

Note

When the battery indicator displays , data transfer cannot be used. Replace the batteries to use data transfer.

6.3.4. ID Numbers

The factory default ID number is "0".

Configure ID numbers using **dedicated peripheral**.



Note

ID numbers cannot be configured with the recorder and require use of a **dedicated peripheral**.



7. Preparing the Recorder

7.1. Installing the Batteries (Replacing Batteries)

Caution

- 
 - Install two new batteries with the correct "+" and "-" direction inside the battery compartment before attaching the recorder.
 - Replace both batteries at the same time.
 - Remove batteries from the recorder if it will not be used for a long period of time. Batteries may leak and cause a malfunction.
 - Use two alkaline batteries: type LR6 or designated rechargeable AA Ni-MH batteries.
 - When installing the battery in the battery compartment, first, push the spring terminal using the "-" terminal of the battery. Next, insert the "+" terminal.
If the battery is installed from the "+" terminal, the coating of the battery may be damaged by the spring terminal.
-  Do not mix different kinds of batteries or used batteries and new batteries. It may cause a leak, heating or damage.

Note

- When the level 1  of the battery level is displayed, replace with two new batteries before attaching the recorder.
- The recorder cannot perform blood pressure measurement or data transfer while the level 1  is displayed.
- When the battery and built-in battery are flat, nothing is displayed.
- Install batteries in accordance with the direction symbol ().

Procedure

- Step 1. Open the battery cover.
- Step 2. Remove the used batteries.
- Step 3. Refer to the direction symbol () inside of the battery compartment. Insert two new batteries in the proper "+" and "-" direction.

Push the spring terminal using the "-" terminal of the battery.

- Step 4. Insert the battery by pushing the "+" terminal.
- Step 5. Insert the second battery using the same method.
- Step 6. Close the battery cover.

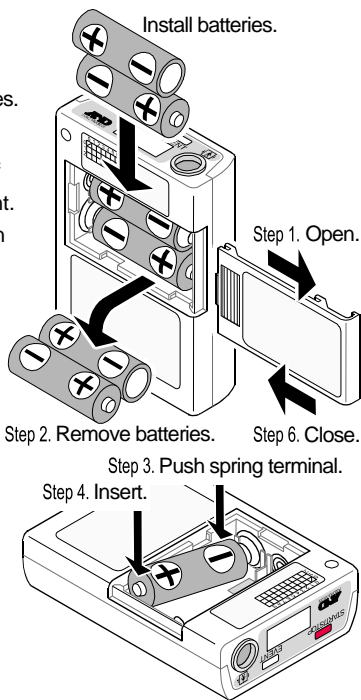

Caution



- Keep the batteries and battery cover away from infants and children to prevent accidental swallowing or other accidents.
- Use standard AA batteries. Do not use a swollen battery, rechargeable battery, or one that is wrapped in tape. It may become difficult to open the cover.

7.1.1. How to Replace Batteries

Measurement results and setting parameters are saved when the batteries are removed. When the built-in battery runs out charge, the date is reset to 01/01/2017 00:00.

Check and adjust the current time when the batteries are replaced.

Refer to "**8.2.2.The Clock and the Monitor Function of Measurement**" to adjust the clock.

7.2. Preparing the Carry Holder

Note

When the carry holder is attached, use the accessory belt.

We recommend to use a belt to fit the recorder to the patient.

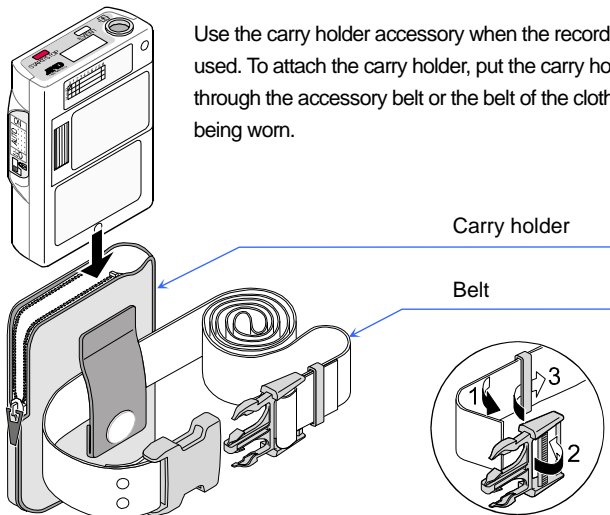

7.3. Inspection for Use

Caution



Inspect the recorder to maintain its performance, safety and effectiveness before use.

Confirm the following checklist before/after installing the batteries.

If a problem is found, stop using the recorder and attach a "**Malfunction**" or "**Do not use**" message. Contact your local dealer to repair it.

7.3.1. Battery Pre-installation Checklists

No.	Item	Description
1	Exterior	No damage and deformation from dropping.
		No damage and looseness of switches, etc.
2	Battery	Check that the batteries are not flat. Replace with two new batteries before the patient uses it.
3	Cuff	Check that the cuff has not frayed. If the cuff is frayed, it may burst due to internal pressure.
4	Cuff connection	Check that there are no kinks and folding in the air hose.
		Check that the air socket and connector is connected firmly.
5	Attachments	Check that there is no damage to accessories. (Carry holder, belt, etc.)

7.3.2. Battery Post-installation Checklists

No.	Portion	Description
1	Battery	Check that there is no fire, smoke and strong smells.
		Check that there is no strange sound.
2	Display	Check that there is no strange display.
3	Operation	Check that the recorder operates correctly.
4	Measurement	Check that the measurement can be performed correctly and that the attachment of the cuff, the measurement, display and results are correct.

8. Operation

8.1. Operation Flowchart

Note

- The initial settings (of the built-in clock, monitor function and initial pressurization value) and preset program (A-BPM and S-BPM) do not need to be stored every time. They are stored when deleted, updated and when the recorder is used for the first time.
- The settings of the recorder can be stored using a **dedicated peripheral**. Refer to the instruction manual for the ABPM Data Manager.

Measurement procedures for A-BPM and S-BPM are different.

- A-BPM can specify six pairs of arbitrary start times and intervals for every 24 hours and can automatically measure and record blood pressure.
- S-BPM assumes that a patient measures their own blood pressure by self-operation at home or in hospital. This mode can use five types of programs in accordance depending on use.

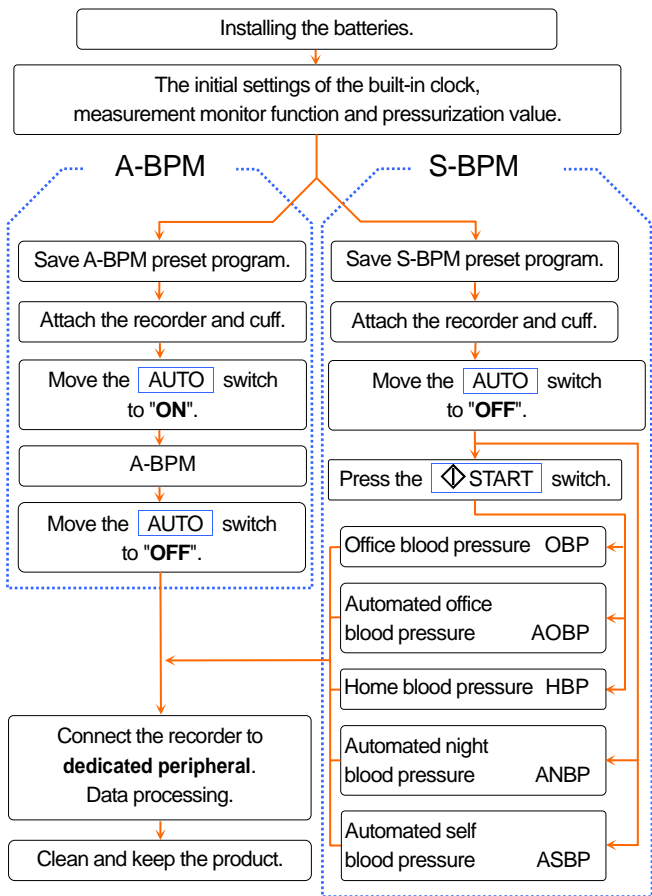

Complete procedure for use

8.2. Initial Settings

8.2.1. Factory Settings

The factory settings (initial settings) are described below:

Common items of the settings

Item	Factory setting
Monitor function	ON (indicated)
Year, Month, Day, Hour, Minute	Date of shipment

Items of A-BPM

Item	Factory setting
Sleep mode	OFF
Interval time when the sleep mode is ON	30 minutes
Start time for section 1	0 hours
Interval time for section 1	30 minutes
Start time for section 2	0 hours #1
Start time for the automated measurement	OFF
Operation time of the automated measurement	OFF

The content of the factory settings

When the switch is moved to "ON", A-BPM starts.

Blood pressure is measured every 30 minutes until the switch is moved to "OFF".

- #1: The settings between the interval time for section 2 and the interval time for section 6 are omitted because the start time for sections 1 and 2 is the same value.

Items of S-BPM

Item	Factory setting	
Program selection	Office blood pressure (OBP)	
Office blood pressure OBP	N.A.	
Automated office blood pressure AOBP	Measurement count	2 counts
	Interval time	5 minutes
Home blood pressure HBP	Measurement count	2 counts
	Interval time	1 minute
Automated night blood pressure ANBP	Start time of section	2 hours
	Measurement count	2 counts
	Interval time	1 minute
Automated self-blood pressure ASBP	Start time of alarm	7 hours, 22 hours
	Measurement count	2 counts
	Interval time	1 minute

The content of the factory settings

When the  switch is pressed after the **AUTO** switch is moved to "OFF", the S-BPM preset program (OBP) is started. The program (OBP) measures the blood pressure once and stores the result in the memory.

8.2.2. The Clock and the Monitor Function of Measurement

The initial settings can be configured using the following methods.

- Using switches on the recorder.
- Using a **dedicated peripheral** that is connected to the recorder using the USB cable.

Procedure of operation using switches

Step 1. Set the **AUTO** switch to "OFF".

Step 2. If the display is hidden, press the **START/STOP** or **EVENT** switch to return to the waiting mode display.

Step 3. While pressing and holding the **START/STOP** switch, press and hold the **EVENT** switch until **Display** (after **Sleep**) is displayed on the OLED.

Step 4. The operation switches are as follows:

EVENT switchChange the current parameter.

START/STOP switchDecision, next item, end of settings.

Then use these switches in another items.

Step 5. After configuring settings, press the **START/STOP** switch to return to waiting mode.

Item	OLED	Range
Monitor function	Display xx	xx = OFF, ON
Year	Clock Year xx	xx = 17 to 99. Last two digits of year.
Month	Clock Mon. xx	xx = 1 to 12 months
Day	Clock Day xx	xx = 1 to 31 days
Hour	Clock Hour xx	xx = 0 to 23 hours
Minute	Clock Min. xx	xx = 0 to 59 minutes

Enclosed characters: Factory settings and initial settings when batteries are consumed completely.

8.2.3. Initial Pressurization Value of S-BPM

An initial pressurization value of S-BPM can be set beforehand.
160, 180, 210, 240, 270, AUTO [mmHg]

If AUTO is specified, a proper initial pressurization value is selected automatically. The factory setting is 180 mmHg.

Step 1. Set the **AUTO** switch to "OFF".

Step 2. If the display is hidden, press the **START/STOP** or **EVENT** switch to return to the waiting mode display.

Step 3. Select a pressurization value using the **START/STOP** switch.

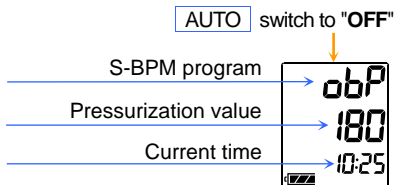

8.3. A-BPM Preset Programs

The initial settings can be configured using the following methods.

- Using the switches on the recorder.
- Using a **dedicated peripheral** that is connected to the recorder using the USB cable.

A-BPM can only be used while the automated measurement can be performed.

Note

Specify the **start time** and **interval** calculated from the time that the **AUTO** switch is set to "ON".

It is necessary to specify them again when using another A-BPM.

Operation using switches

- Step 1. Set the **AUTO** switch to "OFF".
- Step 2. If the display is hidden, press the **START/STOP** or **EVENT** switch to return to the waiting mode display.
- Step 3. While pressing and holding the **START/STOP** switch, press and hold the **EVENT** switch until **Sleep** is displayed on the OLED.
- Step 4. Specify the sleep mode using the following switches.
If the sleep mode is "ON", proceed to step 5.
EVENT switchChange the current parameter.
START/STOP switchDecision, next item.
- Step 5. Specify the **start time** and **interval** in up to six sections using the following switches.
EVENT switchChange the current parameter.
START/STOP switchDecision, next item.
- Step 6. Specify the **start time** and **operation time** of the automated measurement using the following switches.
EVENT switchChange the current parameter.
START/STOP switchDecision, next item, end of settings.
- Step 7. After completing the settings, the recorder returns to its waiting mode.

Caution



Do not remove batteries while charging the settings.
If batteries are removed, input settings again.

8.3.1. A-BPM Items and Parameters

The preset program for A-BPM is as follows:

Item	OLED	Parameter
Sleep mode	Sleep xx	xx = ON, OFF #1, #2
	Interval time Cycle xx	xx = OFF, 5, 10, 15, 20, 30 , 60, 120 minutes
Section 1	Start time Hour 1 xx	xx = 0 to 23 hours
	Interval time Cycle 1 xx	xx = OFF, 5, 10, 15, 20, 30 , 60, 120 minutes
Section 2	Start time Hour 2 xx	xx = 0 to 23 hours
	Interval time Cycle 2 xx	xx = OFF , 5, 10, 15, 20, 30, 60, 120 minutes
Section 3	Start time Hour 3 xx	xx = 0 to 23 hours
	Interval time Cycle 3 xx	xx = OFF , 5, 10, 15, 20, 30, 60, 120 minutes
Section 4	Start time Hour 4 xx	xx = 0 to 23 hours
	Interval time Cycle 4 xx	xx = OFF , 5, 10, 15, 20, 30, 60, 120 minutes
Section 5	Start time Hour 5 xx	xx = 0 to 23 hours
	Interval time Cycle 5 xx	xx = OFF , 5, 10, 15, 20, 30, 60, 120 minutes
Section 6	Start time Hour 6 xx	xx = 0 to 23 hours
	Interval time Cycle 6 xx	xx = OFF , 5, 10, 15, 20, 30, 60, 120 minutes
	Start time START xx	xx = OFF , 0 to 23 hours #3, #4
	Operation time Operation xx	xx = OFF , 1 to 27 hours #3, #4

Automated measurement

Enclosed characters : Factory settings.

- #1 : When the sleep mode is set to "ON", the **start time** and **operation time** of the automated measurement and the **interval time** of the sleep mode can be used. The **interval time** for these sections (1 to 6) cannot be used.
- #2 : When the sleep mode is set to "OFF", the **interval time** for the sleep mode is not displayed.
- #3 : If the **start time** is specified and the **operation time** is set to "OFF", when the AUTO switch is set "ON", the **automated measurement** starts at the preset **start time** and continues until the AUTO switch is set to "OFF". If the AUTO switch is set to "ON" again, the **automated measurement** starts at the preset **start time**.

Note

When the **operation time** is specified, even if the AUTO switch is operated during the **automated measurement**, the **automated measurement** continues for the **operation time** from the time that the AUTO switch is initially set to "ON".

- #4 : If the **start time** is set to "OFF" and the **operation time** is specified, when the AUTO switch is set to "ON", the **automated measurement** performs the first blood pressure measurement and continues for the **operation time**.
If the AUTO switch is set to "OFF" during the **automated measurement**, it stops.
If the AUTO switch is set to "ON" again, the **automated measurement** is performed for the **operation time**.

Note

When the **start time** is specified and the **AUTO** switch is set to "OFF" during the **automated measurement**, it stops.

When the **AUTO** switch is set to "ON" again, the **automated measurement** is started immediately.

The content of the item

Sleep mode:

The **interval time** for the automated measurement can be specified.

The **interval time** of sections 1 to 6 cannot be used. Refer to "[6.1.2.Sleep Function and Interval time](#)".

Section:

24 hours can be divided into six sections at most. Each section can specify the **start time** and **interval**. A-BPM can use only while the automated measurement can be performed.

Automated measurement:

All of the A-BPM can be controlled. Specify the **start time** and **operation time**. Refer to "[8.3.2.A-BPM Program Examples](#)".

8.3.2. A-BPM Program Examples

Example Start times and intervals. Simplified input.

Double sections

The **start time** for section 1 = 7:00

The **interval time** for section 1 = 15

The **start time** for section 2 = 22:00

The **interval time** for section 2 = 60

The **start time** for section 3 = 7:00 The same as section 1

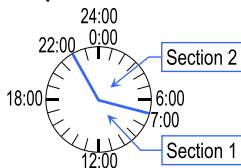

Section 3 and the following items are not displayed because the start time of section 3 is the same as for section 1.

When the **start time** for sections 2, 3, 4, 5 or 6 is the same as for section 1, these **start times** and **intervals** are not displayed.

Example 1 Automatic measurement

The **start time** for the automated measurement = OFF,

The **operation time** for the automated measurement = OFF.

When the AUTO switch is set to "ON", A-BPM is performed according to the **start time** and **interval** of each section until the

AUTO switch is set to "OFF".

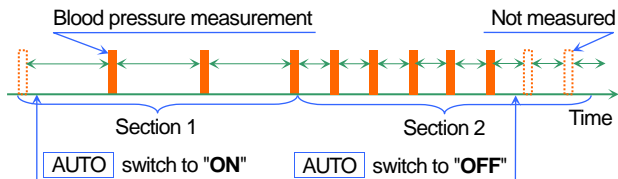

Example 2 Automatic measurement

The **start time** for the automated measurement = 7:00,

The **operation time** for the automated measurement = OFF.

When the **AUTO** switch is set to "ON", A-BPM is started at 7:00.

A-BPM is continued according to the **start time** and **interval** of each section until the **AUTO** switch is set to "OFF".

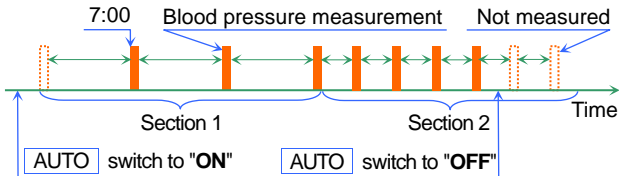

- # Even if the **AUTO** switch is set to "OFF" and to "ON" again during the **automated measurement**, the **automated measurement** continues.

Example 3 Automatic measurement

The **start time** for the automated measurement = OFF,

The **operation time** for the automated measurement = 26 hours.

When the **AUTO** switch is set to "ON", A-BPM continues according to the **start time** and **interval** for each section for 26 hours.

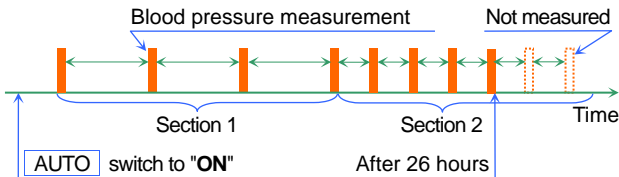

- # Even if the **AUTO** switch is turned to "OFF" once and is turned to "ON" again during the **automated measurement**, the **automated measurement** does not continue beyond the **operation time**.

8.3.3. Start Time and Operation Time

When the **start time** of the **automated measurement** is specified and the **AUTO** switch is set to "ON" and the **automated measurement** is started, the following message is displayed.

If the **start time** is earlier than the current time, the **automated measurement** is started at the **start time** for the next day.

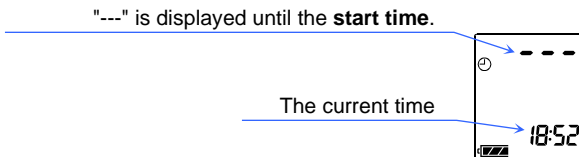

The same "---" is displayed after the **operation time** of the **automated measurement** is finished.

8.4. S-BPM Programs

The initial settings can be configured using the following methods.

- Using switches on the recorder.
- Using a **dedicated peripheral** that is connected to the recorder using the USB cable.

Procedure for operation using switches

Step 1. Set the **AUTO** switch to "OFF".

Step 2. While pressing and holding the  switch, press and hold the **START/STOP** switch until **SEL** is displayed on the LCD.

Step 3. Select S-BPM program using the following switches.

Program: OBP , AOBP, HBP, ANBP, ASBP

 switchChange the current parameter.

START/STOP switchDecision, next item.

Step 4. Specify each item (**Measurement count, Interval time, start time and start time of alarm**) using the following switches.

 switchChange the current parameter.

START/STOP switchDecision, next item, end of settings.

Step 5. After completing settings, S-BPM clock is displayed.

Caution



Do not remove batteries while charging the settings.
If batteries are removed, input settings again.

8.4.1. S-BPM Items and Parameters

Program	Item	Parameter	
S-BPM program			
	Program	[OBP], AOBP, HBP, ANBP, ASBP	
Office blood pressure			
OBP	N.A.	N.A.	
Automated office blood pressure			
AOBP	Measurement count	[2],	1 to 5 counts
	Interval time	[5],	3 to 10 minutes
Home blood pressure			
HBP	Measurement count	[2],	1 to 5 counts
	Interval time	[1],	1 to 5 minutes
Automated night blood pressure			
ANBP	Start time	[2],	0 to 23 hours #1
	Measurement count	[2],	1 to 5 counts
	Interval time	[1],	1 to 5 minutes
Automated self-blood pressure			
ASBP	Start time of alarm	[7], [22],	0 to 23 hours #2
	Measurement count	[2],	1 to 5 counts
	Interval time	[1],	1 to 5 minutes

[Enclosed characters] : Factory settings.

- #1: 24 hours can be separated to six sections in maximum.
Each section can specify the **start time** of the blood pressure measurement.
- #2: 24 hours can be separated to six sections in maximum.
Each section can specify the **start time of alarm** for the blood pressure measurement.

8.4.2. S-BPM Display Examples

Office blood pressure display

OBP *obP*

OBP has no settings to configure.



Automated office blood pressure display

AOBP *AobP*

AOBP uses preset the **measurement count** and **interval time**.

AOBP performs a "1 scope" after a waiting mode to relax.

Refer to "6.2.1.S-BPM Programs" for the "1 scope".



Measurement count



Interval time

Home blood pressure display

HBP *hbP*

HBP uses preset the **measurement count** and **interval time**.

HBP performs a "1 scope".

Refer to "6.2.1.S-BPM Programs" for the "1 scope".



Measurement count



Interval time

Automated night blood pressure display

ANBP *Anb*

The ANBP can specify up to six preset **start times** for the "1 scope". Refer to "6.2.1.S-BPM Programs" for the "1 scope".

When the last **start time** is the same as first **start time**, the settings for **start time** finish. Next, specify the **measurement count** and **interval time** for the "1 scope".

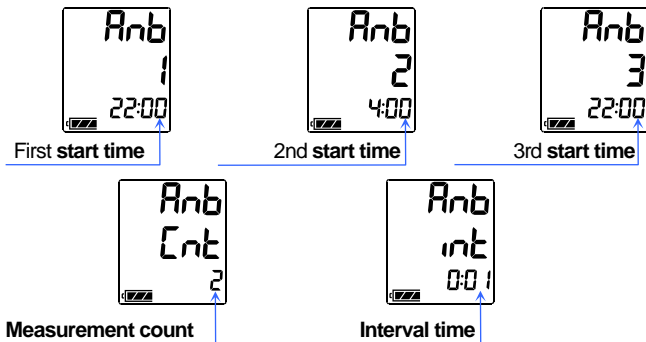

Example Settings and simplified input

The measurement happens at 22:00 and 4:00.

The **start time** of section 1 = 4:00

The **start time** of section 2 = 22:00

The **start time** of section 3 = 4:00 The same as section 1

The **measurement count** = 2 times

The **interval time** = 0:01 minute

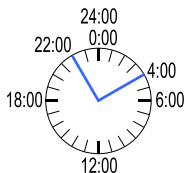

Automated self-blood pressure display

ASBP *ASb*

The ASBP can specify up to six preset **start times** for the alarm.

The buzzer sounds at each **start time**. Press the  switch to perform the "1 scope" when the buzzer sounds.

Refer to "6.2.1.S-BPM Programs" for the "1 scope".

When the last **start time** is the same as first **start time**, the settings for **start time** finish. Next, specify the **measurement count** and **interval time** for the "1 scope".

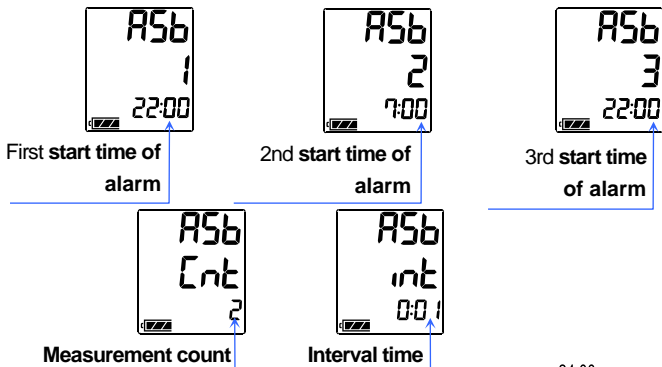

Example Settings and simplified input

- The buzzer sounds at 22:00 and 7:00.
Press the  switch to perform the "1 scope".
- The **start time** of section 1 = 22:00
The **start time** of section 2 = 7:00
The **start time** of section 3 = 22:00 The same as section 1
The **measurement count** = 2 times
The **interval time** = 0:01 minute

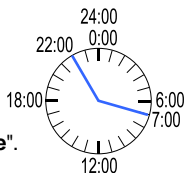

8.5. Deleting Measurement Data

Purpose of operation and explanation of function

Measurement data is deleted but the settings are not deleted.

The initial settings can be configured using the following methods.

- Using switches on the recorder.
- Using a **dedicated peripheral** that is connected to the recorder using the USB cable.

Caution



- If measurement data is deleted, it cannot be used again. Backup the data before deletion.
- Delete the measurement data for the last patient before the next patient uses the recorder.
- Deleting the data may take around ten seconds. Do not operate the device while the data is being deleted to ensure that it is deleted correctly.

Procedure of operation using switches

Step 1. Set the **AUTO** switch to "OFF".

Step 2. If the indication is hidden, press the **START/STOP** or **EVENT** switch to return to the waiting mode display.

Step 3. While pressing and holding the **START/STOP** switch, press and hold the **EVENT** switch until **DataClear** (after **Sleep** and **Display**) is displayed on the OLED.

Step 4. Select an operation.

- If you wish to delete data, press and hold the **START/STOP** switch.

Erasing blinks under **DataClear** on the OLED and the deletion of data starts. Proceed to step 5 after deletion.

- If you keep (do not delete) data, press the **EVENT** switch and proceed to step 5.

Step 5. The recorder returns to the waiting mode.

8.6. Attaching the Product to the Patient

8.6.1. Information for Patients

Explain the following to the patient so that they can use the recorder safely.

Precautions during the blood pressure measurement

- Relax the arm and stay quiet when inflation begins.
- Stay in the same position throughout measurement.
- Avoid vibration and noise during measurement.
- Blood pressure is measured for approximately 1 minute after pressurization. Stay still until measurement finishes. The measurement process between inflating the cuff to releasing the air requires up to 170 seconds.
- The recorder may re-inflate to measure the blood pressure again after the end of pressurization. This may be caused by body motion, etc.
- The recorder may start blood pressure measurement after approximately 120 seconds when measurement data is invalid and the next measurement is 8 minutes later. This may be caused by body motion, etc.
- The recorder may obstruct vehicle and machine operation. Avoid vehicle and machine operation while wearing the recorder.

How to stop or suspend the measurement

Press the START/STOP switch to stop blood pressure measurement. An error code is stored in the memory. Blood pressure is measured again after 120 seconds.

For the A-BPM and ANBP and ASBP modes of S-BPM, only the current blood pressure measurement can be suspended and the **"1 scope"** is performed at the next **start time**. Set the

AUTO switch to **"OFF"** to suspend A-BPM.

Remove the cuff if the current blood pressure measurement cannot be stopped using the **START/STOP** switch.

Caution



- Press the **START/STOP** switch to stop the measurement. The **"1 scope"** is still performed at the next **start time** for A-BPM and the ANBP and ASBP modes of S-BPM.
- When pain in the arm or an unexpected condition occur, stop the measurement, remove the cuff and consult a doctor. Set the **AUTO** switch to **"OFF"** to suspend A-BPM.

Set the **AUTO** switch to **"ON"** to resume A-BPM automated measurement. The  mark is shown on the LCD and OLED. The recording of data continues until switched to **"OFF"**.

How to use manual measurement during A-BPM

The procedure for temporary measurement that is not included in preset program.

- Step 1. If the OLED display is hidden, press the **START/STOP** or **EVENT** switch to return to the A-BPM waiting mode display.
- Step 2. Press the **START/STOP** switch to immediately measure the blood pressure during A-BPM.
- Step 3. Measurement results are stored in the memory. When the **START/STOP** switch is pressed during measurement, the measurement is suspended.

Precautions when wearing the recorder

- ❑ The recorder is a precision instrument. Do not drop or jolt the recorder.
- ❑ The recorder and cuff are not waterproof (water resistant). Protect the product from contact with rain, sweat and water.
- ❑ Do not put anything on the product.
- ❑ When the cuff is moved by excessive motion and exercise, attach the cuff again.
- ❑ Arrange the air hose, so that kinks do not form and so that it does not wrap around your neck at bedtime.

Replacing Batteries

When the  mark is displayed, the recorder cannot measure blood pressure or communicate with a **dedicated peripheral**. Replace with two new batteries immediately.

8.6.2. Cuff Cover

Note

Keep the cuff and cuff cover clean.

- ❑ Change the cuff cover for each person.
- ❑ Use appropriate optional cuff covers.

8.6.3. Attaching the Cuff, Carry holder and Recorder

Caution



- Do not attach the cuff if the patient has dermatitis, external wounds, etc.
- Remove the cuff and cease use if dermatitis or other symptoms appear on the patient.
- Prevent the air hose from coiling around the neck and body.
- Take care when using around infants, as there is a danger of suffocation.
- Insert the connector of the air hose firmly until the end of its rotation. If the connection is incorrect, it may cause air leakage and a measurement error.

Note

- Attach the cuff in the correct position and wrap around the arm to measure blood pressure correctly.
- Prevent the cuff and air hose from vibrating during measurement. The recorder measures a delicate change in the air pressure inside the cuff.
- The accessory cuff is an adult cuff for the left arm. If the cuff size does not fit, purchase an optional cuff.

	Arm circumference	
Small cuff	15 to 22 cm	5.9" to 8.7"
Adult cuff	20 to 31 cm	7.8" to 12.2"
Large cuff	28 to 38 cm	11.0" to 15.0"
Extra-large cuff	36 to 50 cm	14.2" to 19.7"

- Keep the cuff clean.
- We recommend that the patient uses the carry holder and belt.
- The cuff is not made from natural rubber latex.

How to put on the cuff, recorder and holder

- Step 1. Pass the end of the cuff through the ring and make a bracelet shape.
- Step 2. Find the brachial artery in the left arm using palpation.
- Step 3. Attach the cuff directly against the skin, so that the white mark is directly over the brachial artery and the lower edge of the cuff is put on approximately 1 - 2 cm above the inside of the elbow.
- Step 4. Wrap the cuff, so that the ring is within the range, is flat and does not slip down, but there is room to insert two fingers.
- Step 5. Fix the air hose using adhesive tape, so that it passes over the shoulder.
- Step 6. Pass the belt through the carry holder.
- Step 7. Adjust the belt so that the carry holder is on the left side.
- Step 8. Connect the air plug to the air socket on the recorder.
- Step 9. Put the recorder into the carry holder.

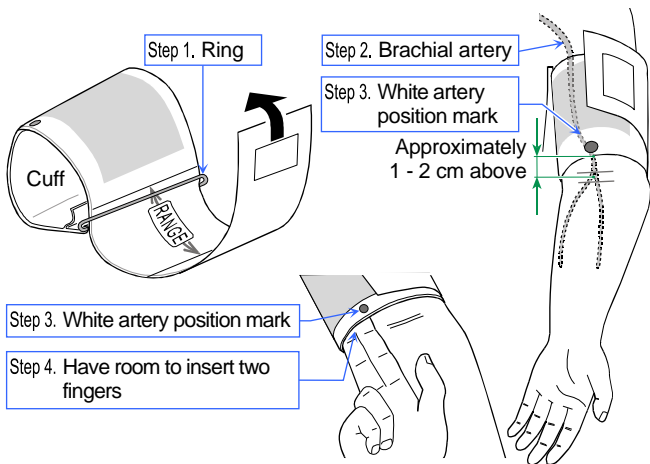

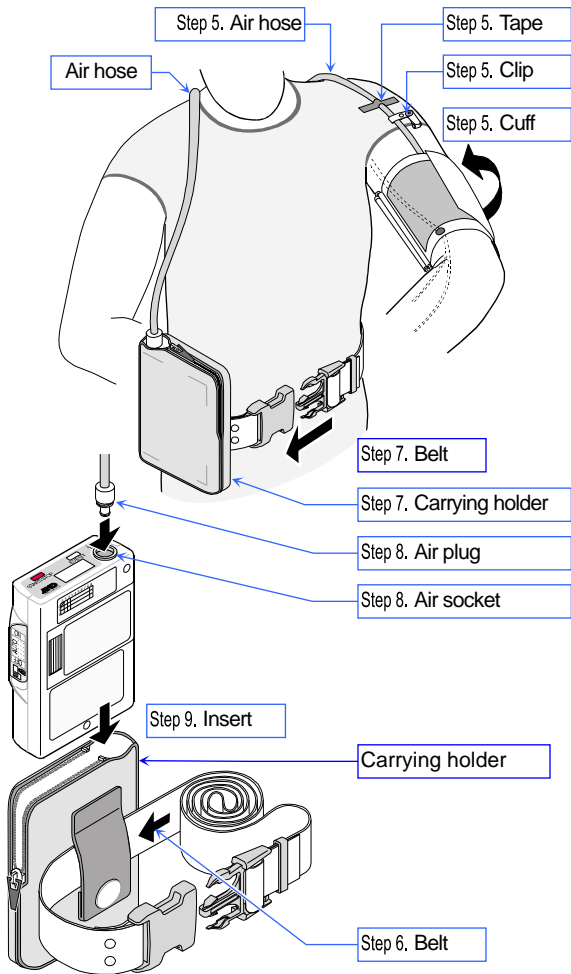

8.7. Blood Pressure Measurement Operations

8.7.1. A-BPM Operations

When A-BPM is started, the blood pressure is measured in accordance with the preset parameters.

Note

- Set the built-in clock and initial pressurization value before measurement, as A-BPM uses them. Refer to "[8.2.2.The Clock and the Monitor Function of Measurement](#)" and "[8.3.A-BPM Preset Programs](#)".
- When the recorder is removed, set the **AUTO** switch to "OFF". If the recorder is removed during A-BPM, the inflation of the cuff starts at the next **start time** and the cuff may burst. When A-BPM is resumed, set the **AUTO** switch to "ON".
- The ⌚ mark is displayed while A-BPM is used.
- Manual blood pressure measurement can be performed during A-BPM waiting mode.
- The measurement result for the manual blood pressure measurement can be stored in the memory.
- When A-BPM is stopped, the error code **E07** is displayed on the OLED and stored in the memory.

To start A-BPM

Step 1. Set the **AUTO** switch to "ON".

Step 2. The ⌚ mark is shown on the OLED and LCD. A-BPM is started.

To suspend A-BPM

Step 1. Set the **AUTO** switch to "OFF".

Step 2. The  mark is hidden. A-BPM is suspended.

To Stop during A-BPM

When the **START/STOP** switch is pressed during blood pressure measurement, the air is expelled immediately and the current measurement is stopped. However, A-BPM is continued. The next blood pressure measurement is performed in accordance with A-BPM settings.

To measure blood pressure during A-BPM immediately (Manual blood pressure measurement of A-BPM)

Step 1. If the OLED display is hidden, press the

START/STOP or **EVENT** switch to return to the A-BPM waiting mode display. The A-BPM **waiting mode** is a state whereby blood pressure is not measured during the **interval time**.



Step 2. Press the **START/STOP** switch during the A-BPM waiting mode.

To double the interval time or reset it

When sleep mode is "ON" and the **EVENT** switch is pressed during A-BPM waiting mode, the interval time is doubled.

8.7.2. S-BPM Operations

Note

- Set the built-in clock and initial pressurization value before measurement because they are used for S-BPM.
Refer to "**8.2.2.The Clock and the Monitor Function of Measurement**" and "**8.4.S-BPM Programs**".
- Remove the batteries when the patient removes the recorder and cuff when ANBP or ASBP is used (even during the waiting mode). If the batteries are left in the battery compartment, the cuff may break when the recorder inflates the cuff at the next "**1 scope**". If the patient resumes measurement, insert the batteries and press the  switch.
- Manual blood pressure measurement can be performed during S-BPM waiting mode.
- The measurement result for the manual blood pressure measurement can be stored in the memory.
- When S-BPM is stopped, the error code  is displayed on the OLED and stored in the memory.

To start S-BPM

Step 1. Set the  switch to "**OFF**".

Step 2. Operations are as follows:

S-BPM Programs		Operations
Office blood pressure	OBP	Press the  switch to start the preset program during waiting mode.
Automated office blood pressure	AOBP	
Home blood pressure	HBP	
Automated night blood pressure	ANBP	Preset program enters standby until the " start time " or " start time of alarm ".
Automated self-blood pressure	ASBP	

To measure blood pressure during S-BPM immediately. (Manual blood pressure measurement for S-BPM)

Step 1. If the LCD display is hidden, press the



START/STOP or **EVENT** switch to return to the S-BPM waiting mode display.

Step 2. Press the  switch during S-BPM waiting mode.

The blood pressure measurements of "**1 scope**" are performed immediately.

To stop or Suspend S-BPM

Operations are as follows:

S-BPM Programs	Operations
Office blood pressure OBP	Press the  switch to stop blood pressure measurement.
Automated office blood pressure AOBP	
Home blood pressure HBP	
Automated night blood pressure ANBP	Press the  switch to stop blood pressure measurement. At next start time, blood pressure is measured or the buzzer sounds. #1
Automated self blood pressure ASBP	
	If you need to stop the recorder completely, remove batteries from the recorder or switch to OBP, AOBP, or HBP.

#1: Refer to "[6.2.1.S-BPM Programs](#)".

8.7.3. Manual Measurement

Use manual blood pressure measurement for a tentative test measurement and immediate blood pressure measurement.

Note

- Manual blood pressure measurement can start immediately in a waiting mode.
- The measurement result is stored in the memory.

To measure blood pressure during A-BPM immediately. (Manual blood pressure measurement for A-BPM)

- Step 1. If the OLED display is hidden, press the **START/STOP** or **EVENT** switch to return to the A-BPM waiting mode display. The A-BPM **waiting mode** is a state that blood pressure is not measured during the **interval time**.
- Step 2. Press the **START/STOP** switch during A-BPM waiting mode.

To measure blood pressure during S-BPM immediately. (Manual blood pressure measurement of S-BPM)

- Step 1. If the LCD is hidden, press the **START/STOP** or **EVENT** switch to return to the S-BPM waiting mode display.
- Step 2. Press the  switch during S-BPM waiting mode. The blood pressure measurements of "**1 scope**" are performed immediately.

8.7.4. Stopping and Suspending Measurements

Ongoing A-BPM, S-BPM and manual blood pressure measurement can be stopped or suspended immediately.

Note

When blood pressure measurement is stopped, the stop code **E07** is displayed on the OLED and is stored in the memory.

To suspend A-BPM

Step 1. Set the **AUTO** switch to "OFF".



Step 2. The ⌚ mark is hidden. A-BPM is suspended.

To stop during A-BPM

When the **START/STOP** switch is pressed during blood pressure measurement, the air is expelled immediately and the current measurement stops. However, A-BPM continues. The next blood pressure measurement is performed in accordance with the A-BPM settings.

To stop or suspend S-BPM

Operations are as follows:

S-BPM Programs	Operations
Office blood pressure OBP	Press the  switch to stop blood pressure measurement.
Automated office blood pressure AOBP	
Home blood pressure HBP	
Automated night blood pressure ANBP	Press the  switch to stop blood pressure measurement. At next start time, blood pressure is measured or the buzzer sounds. #1
Automated self- blood pressure ASBP	

#1: Refer to "[6.2.1.S-BPM Programs](#)".

8.8. Connecting the Recorder to a Dedicated Peripheral

8.8.1. Connecting with a USB cable

Refer to the instruction manual of ABPM Data Manager concerning of the communication settings.

Caution

Connecting the cable

- Connect an authorized USB cable to the micro USB terminal.
- Insert the cable in the correct direction. Improper connection may cause failure and malfunction. Confirm that the terminal cable is properly connected.
- Blood pressure cannot be measured during USB communication.
- ! □ Do not attach to the patient when the recorder is connected to the cable. The cable may become wrapped around the body or neck.

Preparation of a dedicated peripheral

- Remove the recorder and cuff from the patient before connecting the recorder (TM-2441) to a **dedicated peripheral**.
- If the level 1  is displayed, connect the recorder (TM-2441) to the peripherals after replacing the batteries.

To connect the recorder to a dedicated peripheral using the USB cable

Step 1. Open the micro USB terminal on the recorder.

Connect the accessory USB cable.

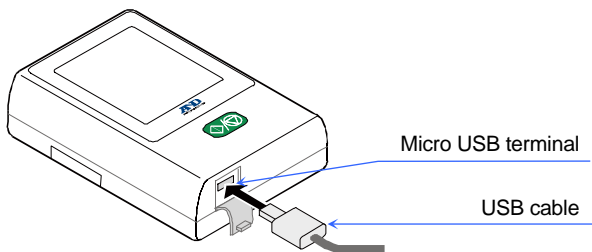

To start data communication with a dedicated peripheral

Step 1. Connect the micro USB cable between the recorder and the **dedicated peripheral**.

Step 2. The buzzer sounds and **usb** is displayed on the LCD. The data communication enters standby mode.

Step 3. Carry out analysis using the **dedicated peripheral**. The data communication only enters active online mode during USB communication.

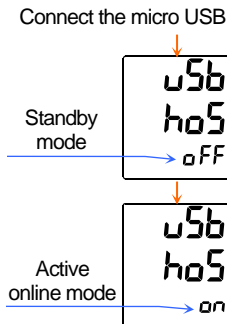

To stop data communication with a dedicated peripheral

Step 1. Remove the cable in the standby mode.

8.8.2. Using *Bluetooth*[®] Communication

A *Bluetooth* device needs to be paired with a device in order to communicate with the device. Once the recorder is paired with a device, devices can automatically communicate.

Note

- Be sure to power off all other *Bluetooth* devices when pairing. Multiple devices cannot be paired at the same time.
- If the recorder is paired with another device, the first device will be unpaired.
- If devices cannot communicate after pairing, try pairing once again.

Bluetooth[®] Pairing

- Step 1. Set the **AUTO** switch to "OFF".
- Step 2. If the display is hidden, press the **START/STOP** or **EVENT** switch to return to the waiting mode display.
- Step 3. Press and hold the **EVENT** switch until **Pairing** (after **FlightMode**) is displayed on the OLED. The recorder starts waiting for pairing.
- Step 4. When *Bluetooth* pairing is complete, the ✂ mark is displayed on the LCD.
- If you cancel the current pairing, press the **EVENT** switch. The recorder proceeds to the waiting mode display.

8.8.3. Suspending *Bluetooth*[®] Communication (Airplane mode)

The airplane mode can suspend *Bluetooth* communication.

Using airplane mode

- Step 1. Set the **AUTO** switch to "OFF".
- Step 2. If the display is hidden, press the **START/STOP** or **EVENT** switch to return to the waiting mode display.
- Step 3. Press and hold the **EVENT** switch until **FlightMode** is displayed on the OLED.
- Step 4. Airplane mode can be turned on/off using the **START/STOP** switch.



- Step 5. Press the **EVENT** switch to return to the waiting mode display.

9. Maintenance

9.1. Product Storage, Inspection and Safety Management

Medical instruments, such as this recorder, must be managed so that they function properly when necessary and reliably ensure the safety of the patient and the operator. As a basic rule, the operator should inspect this instrument daily, such as by following the "Inspection before use".

Daily management, such as inspection before use, is necessary to maintain the performance, safety and effectiveness of the recorder.

We recommend a periodic inspection of the recorder every year.

Note
Medical institutions must perform maintenance management to ensure the safe use of the medical instrument.

9.2. Cleaning the Product

Caution



- ❑ Clean the recorder before use and after use.
Clean the recorder before attaching to the next patient.
- ❑ Do not spray water and immerse in water to clean the recorder.
This may cause a malfunction.
- ❑ Dry the recorder after wiping it with water and the antiseptic solution, so that the liquid does not penetrate the recorder.
- ❑ Disinfect the recorder periodically to ensure infection prevention.
Do not use a sterilizer on the recorder.
- ❑ Do not use an organic solvent (for example: thinner) or povidone-iodine solution to clean the recorder. It may cause discoloration, damage and malfunction.
- ❑ Do not use a hair dryer etc. to dry the recorder. It may cause malfunction and damage.

Confirmation after Cleaning the Cuff

- ❑ Confirm that the cuff bladder is correctly inserted inside the cuff cloth. If it is not correctly inserted, damage or explosion may occur during inflation.

Cleaning the recorder

Wipe the dirt and dust from the exterior case of the recorder using gauze moistened with water or warm water and squeezed well. When blood or medicines, etc. adhere to the case, firstly, clean with gauze moistened with antiseptic solution and squeezed well. Then, wipe the wet case using gauze moistened with water or warm water and squeezed well. We recommend using chemicals (ingredient name) from the antiseptic solution listed in the table (**Example of useable antiseptic solution (Ingredient name)**).

Cleaning the cuff

When you clean and disinfect the cuff cover and cuff cloth, remove the cuff bladder inside the cuff cloth. Clean the dirt and dust using gauze moistened with water or warm water and squeezed well. Refer to the antiseptic solutions in the table (**Example of useable antiseptic solution (ingredient name)**) when disinfecting.

Example useable antiseptic solution (Ingredient name)

Component Name	Product Name
Benzalkonium chloride	Benzalkonium chloride 10% solution
Isopropanol	70% in 1-propanol
Ethanol	Ethanol for disinfection 76.9 to 81.4 vol%

Read the prescription described on the product and use it.

Note

The cuff and air hose are consumables.

If a measurement error occurs frequently or blood pressure cannot be measured, replace them with new ones. Refer to "**10.Optional Items (requiring order)**" in this manual.

9.3. Periodic Inspection

Perform the daily periodic inspection to use the recorder correctly.
The inspection is described below:

9.3.1. Battery Pre-installation Inspection

Items	Description
Exterior	No damage or deformation from dropping.
	No dirt, rust and scratches on any part.
	No cracking or rattling of the panel.
Operation	No damage or rattling of switches and buttons.
Display	No dirt or scratches on the display panel.
Measurement Cuff	<ul style="list-style-type: none">□ The air hose must not be folded. If air remains in the cuff, it may cause peripheral dysfunction from stopping the blood flow in the arm.
	<ul style="list-style-type: none">□ The cuff bladder is correctly inserted inside the cuff cloth.
	<ul style="list-style-type: none">□ No fraying of the cuff. The cuff doesn't ravel.
	Replace the cuff when a problem is found. The cuff is disposable.
	<ul style="list-style-type: none">□ If there is a crack or adhesive matter in the connection between the cuff and cuff bladder.□ If the air hose loses its flexibility and becomes hard.□ When the surface of the air hose becomes glossy or feels oily.□ When the air bladder has cracks.
	We recommend replacing cuffs every three years, regardless of frequency of use.
Wearing tools	No damage in the carry holder, belt and cuff.
Connection	The air plug is connected to the air socket correctly.

9.3.2. Battery Post-installation Inspection

Item	Description
Exterior	No fire, smoke or strong smells.
	No strange sounds.
Operation	No trouble with the functioning of switches and buttons.
Measurement Cuff	Measurement values are close to the usual value.
	No strange sounds or actions during measurement.
Inspection of blood pressure value	If blood pressure values are incorrect, contact your local dealer.

9.4. Disposal



Follow the laws of the local government for environmental protection for the disposal and recycling of the product.

Disposal of the cuff

The cuff worn on the patient is medical waste.

Dispose of it properly as medical waste.

Disposal of the rechargeable built-in battery

 Caution	
	The recorder is equipped with a backup battery inside. When disposing of the recorder, dispose of the battery properly in accordance with the local regulations for environmental protection.

Others

Name	Part	Material
Package	Case	Cardboard
	Cushion	Air cushion, special case
	Bag	Vinyl
Recorder	Case	ABS + PC resin
	Internal parts	General parts
	Chassis	Iron
	Backup battery on the board	Lithium rechargeable coin cell battery: ML2016H
	Battery	Alkaline battery: 1.5V LR6 or AA size Rechargeable battery: AA size Ni-MH batteries, 1900 mAh or more

9.5. Troubleshooting

Consult the following checklist and error code list before contacting your local dealer.

If these measures do not rectify the problem or the problem occurs again, contact your local dealer.

Problem	Main cause	Treatment
No display after pressing any switches.	Battery power has been consumed.	Replace with new batteries.
No OLED display during A-BPM.	OLED may disappear due to the electrostatic effect.	Remove batteries and reinstall them.
Frequent clock reset.	The backup battery does not charge. #1	Charge for 48 hours using new batteries.
No pressurization	Cuff is not connected correctly.	Check the cuff and air hose for folding, kinks and connection.
No USB communication #2	The communication cable is removed.	Confirm that the cable is connected correctly.
Communication response takes time. #2	The dedicated peripheral is downloading a large amount of environmental data for a long time.	Wait for the end of the download. It may need 50 minutes at most.
Battery cover cannot be opened	Non-standard size batteries were used.	Contact your local dealer.

#1: Users (unauthorized maintenance personnel) cannot replace the backup battery (lithium battery) on the circuit board inside the recorder. The backup battery is charged from the batteries (LR6 or AA size) for measurement.

#2: **A dedicated peripheral** is required.





Caution



Do not disassemble or modify the recorder. It may be damaged.

9.6. Error Codes

Measurement error codes

Code	Meaning	Cause and treatment
E03	Pressure zero error	Release the air left in the cuff.
E04	Low battery	Replace with new batteries.
E05	Failure of pressurization	<ul style="list-style-type: none"> □ Inflation does not reach the target pressure. □ Check the cuff connection. □ If there are no problems with the cuff connection, the recorder may have malfunctioned and requires inspection.
E06	Pressure exceeds 299 mmHg	Body motion may occur during pressurization. Relax and keep still during measurement. If this does not help, inspect the recorder.
E07	Force stop using  or  switch.	Press the  or  switch only when necessary.
E08	Blood pressure cannot be measured.	<ul style="list-style-type: none"> □ The heartbeat cannot be detected due to body motion or noise from clothes. □ Relax and do not move. □ Confirm the position of the cuff. □ If this failure occurs even when relaxed, contact your dealer to inspect and repair the recorder.
E09	Built-in acceleration sensor error.	Remove the batteries and reinstall them.

Code	Meaning	Cause and treatment
E10	Excessive body motion.	Relax and keep still during measurement.
E20	Out of range, $30 \leq \text{PUL} \leq 200$	If these errors occur multiple times, try another blood pressure measurement. #1 PP = SYS - DIA SYS: Systolic blood pressure DIA: Diastolic blood pressure PP: Pulse pressure
E21	Out of range, $30 \leq \text{DIA} \leq 160$	
E22	Out of range, $60 \leq \text{SYS} \leq 280$	
E23	Out of range, $10 \leq \text{PP} \leq 150$ #1	
E30	Measurement is above 180 seconds.	If the inflation speed or exhaust speed is slow, an inspection is necessary.
E31	Exhaust is above 90 seconds.	The exhaust speed may be slow, an inspection is necessary.
E48	Heartbeat cannot be detected.	Heartbeat cannot be detected because of body motion, etc. Measure the blood pressure while relaxed and do not move.
E60	The settings of the interval time are incorrect.	If the interval time is set to 120 minutes, the difference between last start time and next start time cannot divide into two hours perfectly.
E90	Zero pressure error for safety circuit.	<ul style="list-style-type: none"> □ Displays at the measurement start time. □ Release the air remaining in the cuff completely.

Code	Meaning	Cause and treatment
E91	Safety circuit detects over load pressure.	<ul style="list-style-type: none"> □ Body motion may be detected during pressurization. Relax and do not move during the measurement. □ If this error occurs even when relaxed and not moving, contact your dealer for inspection.

Hardware error codes on the recorder

Code	Meaning	Cause and treatment
E52	Memory error	<ul style="list-style-type: none"> □ It may happen in case of a strong impact, such as dropping the recorder. □ If this code displays frequently, there is a malfunction in the built-in memory. Contact your dealer for inspection.

Note

The error codes may be changed without any notice.

10. Optional Items (requiring order)

Cuffs

Name	Description	Order code
Small cuff for left arm	Arm circumference 15 to 22 cm 5.9" to 8.7"	TM-CF202A
Adult cuff for left arm	Arm circumference 20 to 31 cm 7.8" to 12.2"	TM-CF302A
Large cuff for left arm	Arm circumference 28 to 38 cm 11.0" to 15.0"	TM-CF402A
Extra-large cuff for left arm	Arm circumference 36 to 50 cm 14.2" to 19.7"	TM-CF502A
Adult cuff for right arm	Arm circumference 20 to 31 cm 7.8" to 12.2"	TM-CF802A
Disposable cuff	10 sheets	TM-CF306A
Small cuff cover	for left arm 10 sheets	AX-133024667-S
Adult cuff cover	for left arm 10 sheets	AX-133024500-S
Large cuff cover	for left arm 10 sheets	AX-133024663-S
Extra-large cuff cover	for left arm 10 sheets	AX-133024503-S
Adult cuff cover	for right arm 10 sheets	AX-133024353-S
Small cuff cloth	for left arm 2 sheets	AX-133025101-S
Adult cuff cloth	for left arm 2 sheets	AX-133024487-S
Large cuff cloth	for left arm 2 sheets	AX-133025102-S
Extra-large cloth	for left arm 2 sheets	AX-133025103-S
Adult cuff cloth	for right arm 2 sheets	AX-133025104-S
Air hose adaptor	–	TM-CT200-110

Data analysis

Name	Description	Order code
USB cable	–	AX-KOUSB4C

Others

Name	Description	Order code
Activity record sheet	10 sheets	AX-PP181-S
Carry holder	–	AX-133025995
Belt	–	AX-00U44189
Clips	5 pieces	AX-110B-20-S

11. Appendix

11.1. Principle of Blood Pressure Measurement

Measurement procedure: Wrap the cuff around the upper arm. Inflate the cuff to a pressure exceeding the systolic blood pressure. Then, exhaust the air from the cuff gradually. While the pressure is detected in the cuff in the air exhaustion stage, the pulse waveform appears in synchronization with the heartbeat. The pulse waveform suddenly increases near the systolic blood pressure. It increases further with exhaustion until it reaches its highest amplitude, then decreases gradually. The changes in the pulse waveform are illustrated on the next page. In oscillometric blood pressure measurement, the systolic blood pressure is specified as the point where the amplitude increases suddenly after the pulse in the cuff pressure is detected, while the mean blood pressure is specified as the point where the amplitude reaches its maximum and the diastolic blood pressure is specified as the point where the amplitude decreases gradually. Actually, the pressure sensor detects subtle changes in the cuff pressure over time, stores the pulse waveform in memory and evaluates the systolic and diastolic blood pressures according to the oscillometric measurement algorithm. The details in the algorithm vary with the blood pressure monitor. Blood pressure values for adults and infants are measured by the oscillometric method and are compared with those measured by the auscultatory method. Diastolic blood pressure is defined as the end point of phase 4 in the auscultatory method. The pulse waveform of the cuff pressure depends on the characteristics of the cuff material. Therefore, by using the specified cuff and the measurement algorithm, the measurement accuracy is maintained. The air hose length is less than 3.5 m, because of the damping characteristics due to pulse wave propagation.

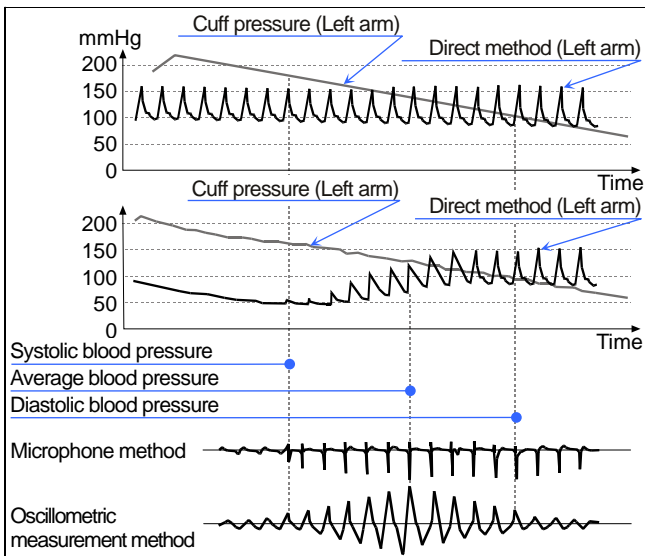

Blood pressure measurement error factors

The pulse graph can be an objective indicator of the reliability of the measurement accuracy. When noise occurs due to irregular heartbeat or physical movements, the amplitude of the graph changes. When the pulse graph is not a smooth outline, check again or use other methods.

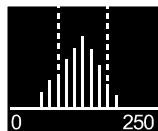

Pulse graph

Cuff position at the same height as heart

Wrap the cuff around the arm at the same level as the heart. If the cuff position is incorrect, a measurement error occurs. For example, if the cuff is 10 cm lower than the heart level, the blood pressure is measured 7 mmHg higher.

Proper cuff size

Use a cuff of adequate size. If it is too small or too big, a measurement error occurs. Measurements with a cuff that is too small tend to be evaluated as high blood pressure, regardless of the proper blood pressure and normal arteries. Measurements with too large a cuff tend to be evaluated as low blood pressure, especially for those who suffer from severe arteriosclerosis or have abnormal arterial valves. The wrong cuff size is a cause of differences between the direct method and oscillometric measurement method. The cuff has the range of the arm circumference shown on the label. Select and attach the proper size cuff for each patient. The accuracy of the blood pressure measurement is guaranteed by the pressure accuracy of the pressure sensor, exhaust characteristics and measurement algorithm, so long as the proper cuff and air hose are used. Inspect the pressure accuracy of the pressure sensor and exhaust characteristics periodically.

11.2. EMD Information

The requirements that apply to medical electronic instruments are described below:

Performance within the EMD guidelines

The use of the recorder require special precautions for EMD (Electromagnetic Disturbances). Operate the recorder in accordance with the warnings for EMD described in this manual. Portable and mobile RF communication equipment (e.g. cell phones) can affect medical electrical equipment.

Accessories compliant with EMD standards

The accessories and options for this recorder meet the conditions of IEC60601-1-2: 2014 + A1: 2020. If an unauthorized accessory is used, it may cause increasing emissions and lower noise immunity.

Warning



Use accessories designated by the A&D company. Unauthorized accessories may be influenced by electromagnetic emission and have reduced immunity against disturbances.

EMISSIONS LIMITS

Phenomenon	Compliance
Radiated RF emission CISPR11	Group 1, Class B

IMMUNITY TEST LEVELS: Enclosure Port

Phenomenon	Immunity test levels
Electrostatic discharge IEC 61000-4-2	± 8 kV contact ± 2 kV, ± 4 kV, ± 8 kV, ± 15 kV air
Radiated RF EM fields IEC 61000-4-3	10 V/m 80 MHz - 2.7 GHz 80 % AM at 1 kHz
Proximity fields from RF wireless communications equipment IEC 61000-4-3	See table (Test specifications for ENCLOSURE PORT IMMUNITY to RF wireless communications equipment)
Rated power frequency magnetic fields IEC 61000-4-8	30 A/m 50 Hz/60 Hz
Proximity magnetic field IEC 61000-4-39	See table (Test specifications for ENCLOSURE PORT IMMUNITY to proximity magnetic field)

IMMUNITY TEST LEVELS: PATIENT COUPLING Port

Phenomenon	Immunity test levels
Electrostatic discharge IEC 61000-4-2	± 8 kV contact ± 2 kV, ± 4 kV, ± 8 kV, ± 15 kV air

IMMUNITY TEST LEVELS: Signal input/output Port

Phenomenon	Immunity test levels
Electrostatic discharge IEC 61000-4-2	± 8 kV contact ± 2 kV, ± 4 kV, ± 8 kV, ± 15 kV air
Electrical fast transients/bursts IEC 61000-4-4	± 1 kV 100 kHz repetition frequency
Conducted disturbances induced by RF fields IEC 61000-4-8	3 V 0.15 MHz - 80 MHz 6 V in ISM and amateur radio bands between 0.15 MHz and 80 MHz 80% AM at 1 kHz

Test specifications for ENCLOSURE PORT IMMUNITY to RF wireless communications equipment

Test frequency (MHz)	Band (MHz)	Service	Modulation	Immunity test level (V/m)
385	380 - 390	TETRA 400	Pulse modulation 18 Hz	27
450	430 - 470	GMRS 460 FRS 460	FM ± 5 kHz deviation 1 kHz sine	28
710	704 - 787	LTE Band 13,17	Pulse modulation 217 Hz	9
745				
780				
810	800 - 960	GSM 800/900 TETRA 800 iDEN 820 CDMA 850 LTE Band 5	Pulse modulation 18 Hz	28
870				
930				
1720	1700-1990	GSM 1800 CDMA 1900 GSM 1900 DECT LTE Band 1,3,4,25 UMTS	Pulse modulation 217 Hz	28
1845				
1970				
2450	2400-2570	Bluetooth WLAN 802.11 b/g/n RFID 2450 LTE Band 7	Pulse modulation 217 Hz	28
5240	5100-5800	WLAN 802.11 a/n	Pulse modulation 217 Hz	9
5500				
5785				

Test specifications for ENCLOSURE PORT IMMUNITY to proximity magnetic field

Test frequency	Modulation	Immunity test level (A/m)
30kHz	CW	8
134.2kHz	Pulse modulation 2.1kHz	65
13.56MHz	Pulse modulation 50kHz	7.5

THIS PAGE INTENTIONALLY LEFT BLANK.



A&D Company, Limited

1-243 Asahi , Kitamoto-shi, Saitama-ken 364-8585 Japan
Telephone: [81] (48) 593-1111 Fax: [81] (48) 593-1119

<http://www.aandd.jp>

EC REP

Emergo Europe B.V.

Westervoortsedijk 60, 6827 AT Arnhem, The Netherlands

A&D INSTRUMENTS LIMITED

Unit 24/26 Blacklands Way, Abingdon Business Park, Abingdon, Oxfordshire
OX14 1DY, United Kingdom

Telephone: [44] (1235) 550420 Fax: [44] (1235) 550485

<http://www.andmedical.co.uk/>

A&D Engineering, Inc.

4622 Runway Boulevard, Ann Arbor, MI 48108 USA

Telephone: [1] (888) 726-9966

<http://www.andonline.com/medical/>

A&D AUSTRALASIA PTY LTD

32 Dew Street, Thebarton, South Australia 5031, AUSTRALIA

Telephone: [61] (8) 8301-8100 Fax: [61] (8) 8352-7409

<http://www.andmedical.com.au/>

ООО А&Д РУС

121357, Российская Федерация, г.Москва, ул. Верейская, дом 17
(Business-Center "Vereyskaya Plaza-2" 121357, Russian Federation, Moscow, Vereyskaya Street 17)
тел.: [7] (495) 937-33-44

ООО "ЭЙ энд ДИ РУС"

факс: [7] (495) 937-55-66

<http://www.and-rus.ru/>

A&D Technology Trading(Shanghai) Co. Ltd

爱安德技研贸易(上海)有限公司

中国 上海市浦东新区 浦东南路 855 号 世界广场 32 楼 CD 座 邮编 200120
(32CD, World Plaza, No.855 South Pudong Road, Pudong New Area, Shanghai, China 200120)

电话: [86] (21) 3393-2340

传真: [86] (21) 3393-2347

<http://www.aanddtech.cn/>

A&D INSTRUMENTS INDIA PRIVATE LIMITED

509, Udyog Vihar, Phase-V, Gurgaon - 122 016, Haryana, India

फोन : [91] (124) 4715555

फैक्स : [91] (124) 4715599

<http://www.aanddindia.in/>

CE 0123