

Noise & Vibration Analysis Systems

Hardware development starting from A/D conversion technology

Software development with high-speed DSP and wave analysis technology



A&D Company, Limited
3-23-14 Higashi-Ikebukuro, Toshima-ku, Tokyo 170-0013 JAPAN
Telephone: [81](3) 5391-6132 Fax: [81](3) 5391-6148
http://www.aandd.jp

A&D ENGINEERING, INC.
1756 Automation Parkway, San Jose, CA 95131 U.S.A.
Telephone: [1](408) 263-5333 Fax: [1](408) 263-0119

A&D Australasia Pty Ltd.
32 Dew Street, Thebarton, South Australia 5031 AUSTRALIA
Telephone: [61](8) 8301-8100 Fax: [61](8) 8352-7409

A&D INSTRUMENTS LTD.
Unit 24/26 Blacklands Way Abingdon Business Park,
Abingdon, Oxon OX14 1DY UNITED KINGDOM
Telephone: [44](1235) 550420 Fax: [44](1235) 550485

<German Sales Office>
Hamburger StraÙe 30 D-22926 Ahrensburg GERMANY
Telephone: [49](0) 4102 459230 Fax: [49](0) 4102 459231

A&D KOREA Limited
Manhattan Bldg. 8F, 36-2 Yeido-dong, Youngdeungpo-gu, Seoul, KOREA
Telephone: [82](2) 780-4101 Fax: [82](2) 782-4280

A&D RUS CO, LTD.
Verenskaya str.17, Moscow, 121357 RUSSIA
Telephone: [7] (495) 937-33-44 Fax: [7] (495) 937-55-66

A&D Instruments India Private Limited
509 Udyog Vihar Phase V
Gurgaon-122 016, Haryana, INDIA
Telephone: [91](124) 471-5555 Fax: [91](124) 471-5599



Starting in 1983 with the FFT Analyzer (AD3521) boasting world class performance consistently, up to our latest measurement, control and simulation devices, A&D has been responsible for developing devices with high level noise and vibration analysis capability and high speed digital signal processing technology.



A&D Technical Center and DSP ToolLab.

1-channel/AD3552

Dedicated FFT comparator
Works well for quality assessment of defects on the production line
Can also be used for noise or vibration monitoring

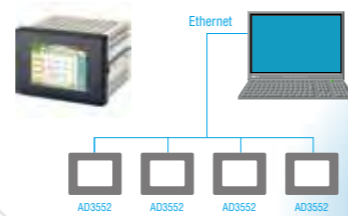

WCA Lite

Sound analyzer / Noise analyzer / FFT analyzer
Basic FFT analysis function
A simple and convenient World Class Analyzer

4-channel/WCAmini

Small size, lightweight, USB powered unit
Freedom to carry from the place of measurement on urgent business
From FFT analysis to tracking analysis
Noise and vibration analysis full support



A&D Noise & Vibration Analysis Device Lineup

4 to 64 Channels CompactWCA

A4 size 16-channel housing unit
Can be extended to up to 64 channels by simultaneously connecting units
From car-mounted measurement to multiple channel measurement
Noise and vibration analysis full support



Post-processing/WCAPRO

Online analysis for time series data
From FFT analysis to tracking analysis
Noise and vibration analysis full support



In order to better meet the needs of our customers, A&D has produced a multi-functional noise and vibration analysis system that combines the best features of our family of products based on DSP and noise & vibration analysis technology developed since our founding (from 1-channel dedicated comparators to total measurement engine bench systems)

192ch For Multiple Channel Vibration Testing Measurement Analysis Device

Random testing
Sine wave testing
Impact testing



General Measurement

Revolutionizing engine test bench measurement
Measurement system based on AD5440
Measurement control, monitoring, collection, capture, analysis

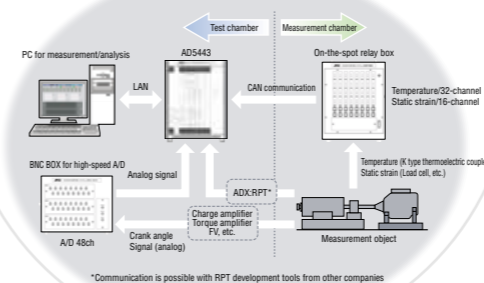

A level of customization learnt from a wealth of experience

CompactWCA and WCAmini can be customized into an original noise and vibration analysis system for the user
Streamlining of testing work, automatic measurement

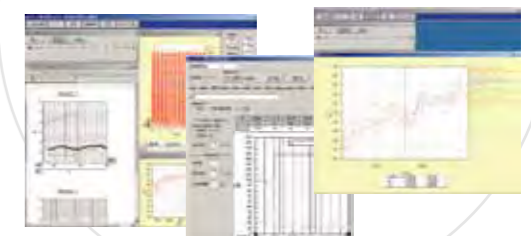

FFT Comparator

AD3552



Features

- ▶ Easy operation by LCD touch panel
- ▶ Ethernet, DIO and Serial Board are standard features on the interface
- ▶ Automation of quality judgments for defects on the production line
- ▶ Detects irregular performance in machinery early
- ▶ Contributes to prevention of breakage of equipment or testing devices when irregularities occur

- **Small and lightweight 1 x 1.4DIN unit which can easily slot into a rack**
- **Easy to operate dedicated comparator**
- **Achieve central control and network compatibility**

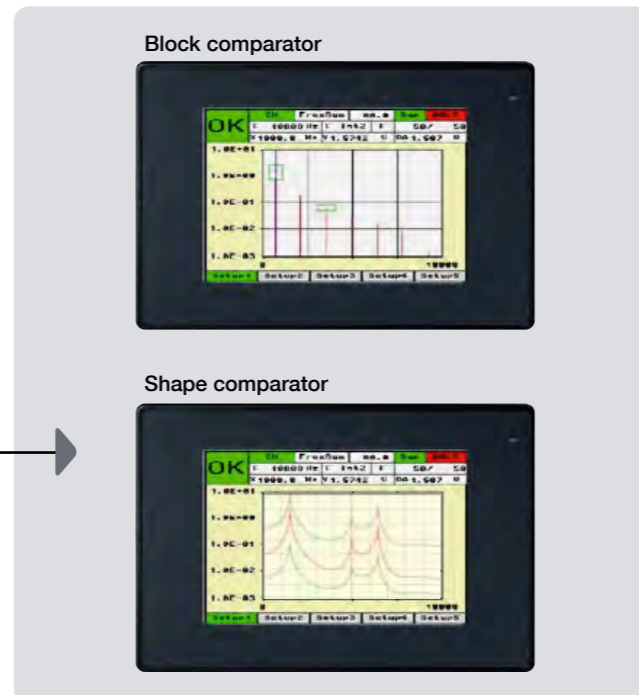
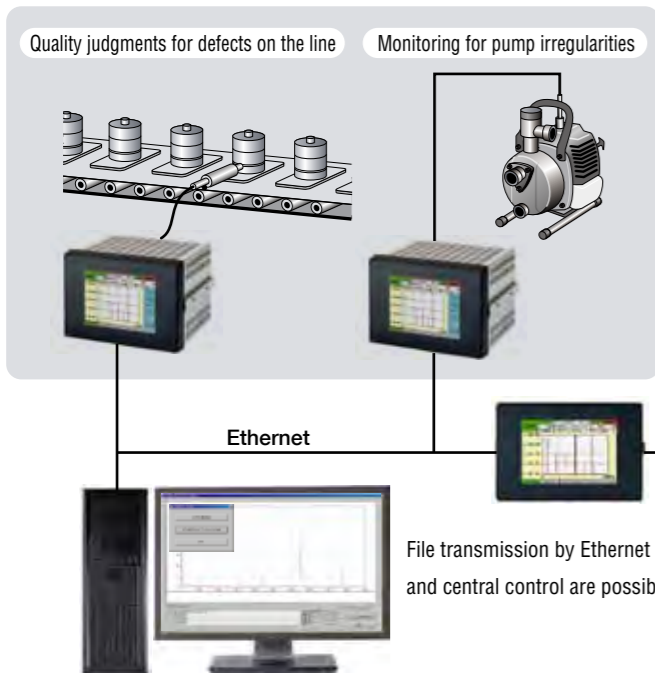
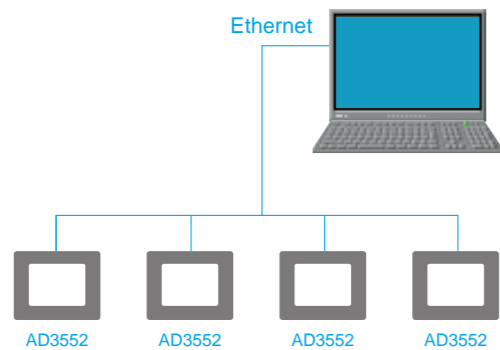

Small 4-channel Noise & Vibration Analysis System

WCAmini AD3661



Features

- ▶ USB powered unit (no AC adapter required)
- ▶ 24-bit, 4-channel measurement (TEDS compatible)
- ▶ Dedicated channel for tachometer pulse measurement
- ▶ Multi-analysis WCAPRO-compatible software
- ▶ FFT analysis, throughput recording and playback analysis
- ▶ Real-time octave analysis (optional)
- ▶ Tracking analysis (optional)
- ▶ Filtering function (optional)
- ▶ Voice memo input and sound playback
- ▶ Includes easy-to-use measurement assistance menu

- **Small and lightweight USB powered unit**
- **User-friendly GUI and simple support menu**
- **Compatibility with CompactWCA and WCAonPC**
- **Full support provided for this minimum configuration device which still provides equivalent analysis to multiple channel systems**

Small and light enough to fit into your travel case

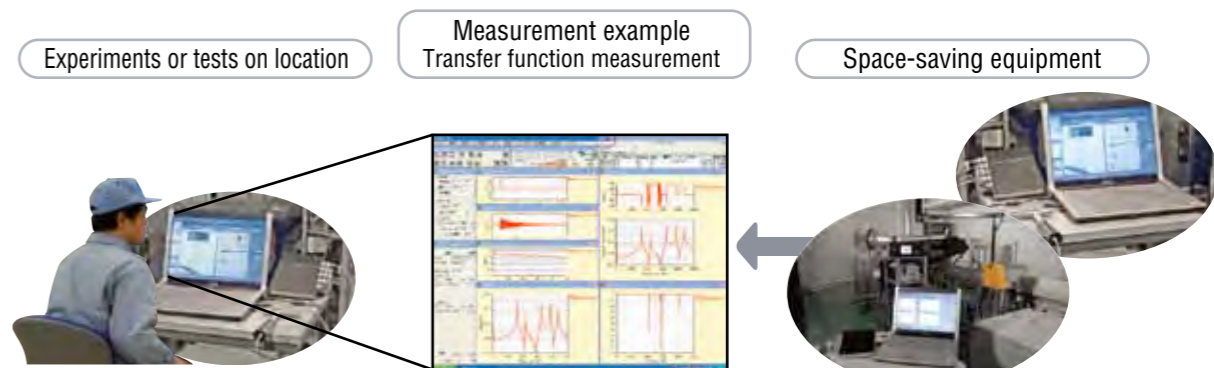
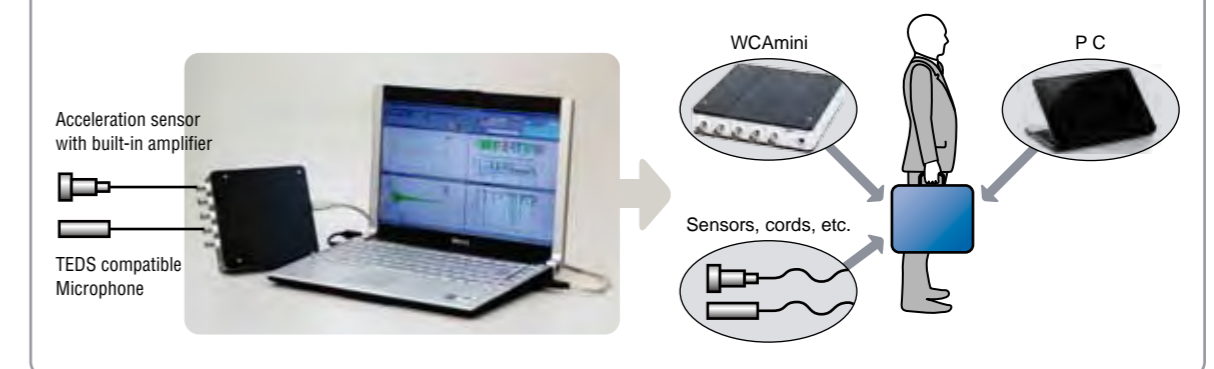

Sound Analyzer / Noise Analyzer / FFT Analyzer

WCA Lite



A simple and convenient World Class Analyzer (WCA)

Features

- ▶ Basic FFT analysis function
- ▶ Time function
- ▶ Spectrum
- ▶ Auto-power spectrum
- ▶ Power spectrum density function
- ▶ Transfer function (H1)
- ▶ Coherence function
- ▶ 1/1, 1/3 octave

Specifications

Input		Analysis	
Number of Input Channels	4	Frame Size	64, 128, 256, 512, 1024, 2048, 4096, 8192, 16384, 32768, 65536
Input Impedance	1 MΩ	Frequency Range	40kHz - maximum
Input Coupling	AC, DC, ICP	Real-time Analysis Frequency	20kHz
Input Range	-20dB (141mV), 0dB (1.41V), +20dB (14.1V)	A/D Converter	24 bits
Trigger Source	Input Channel, External Input	Dynamic Range	100dB

1 Vibration measurement example: results using 4 acceleration sensors
 (Results from attaching acceleration sensors in 4 different places and measuring on 4 channels simultaneously)

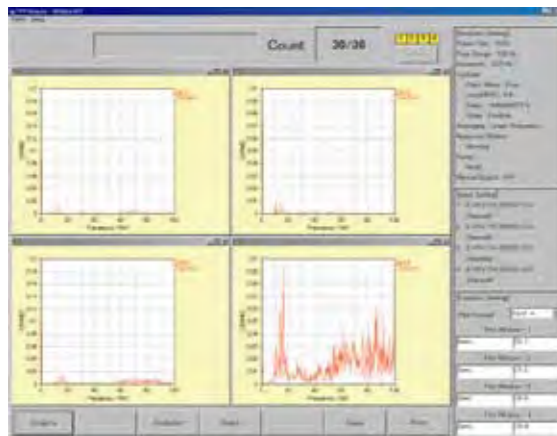

2 Noise measurement example: results using a microphone
 (Measurement results from a microphone placed 1 meter away from the object being measured)

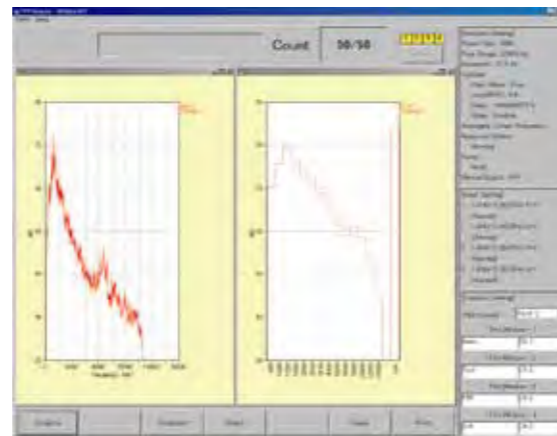

3 Transfer function measurement example
Results using an impulse hammer and a single-axis acceleration sensor
 (Measurement of the response acceleration spectrum of the z-axis direction after inducing vibration in the same z-axis direction of the object being measured)

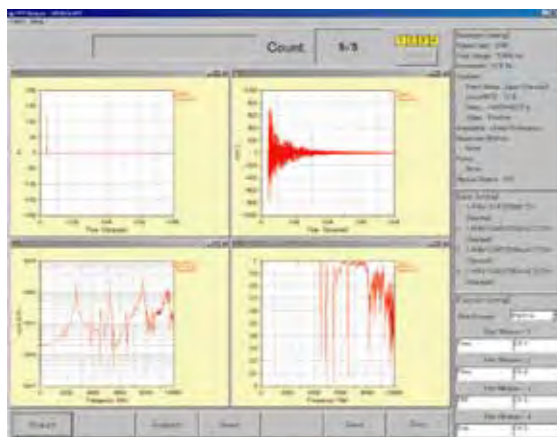

4 Transfer function measurement example
Results using an impulse hammer and a triple-axis acceleration sensor
 (Measurement of the response acceleration spectra of 3 axes directions (x, y & z) while simultaneously inducing vibration of the z-axis direction of the object being measured)

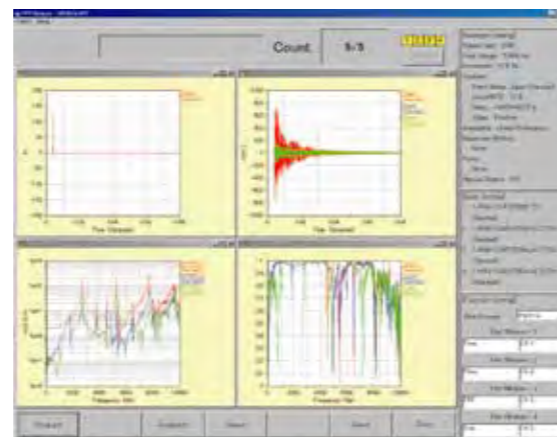

In-vehicle Realtime Noise & Vibration Analysis System

Compact WCA AD3651



Noise & Vibration Analysis System for Applications from In-vehicle Tracking Analysis to Multi-point Excitation

Features

- ▶ Compact A4-size design
- ▶ 24 bit AD used
- ▶ Realtime octave analysis (optional)
- ▶ Tracking analysis (optional)
- ▶ Filtering function (optional)
- ▶ Throughput function a standard feature
- ▶ Battery for in-vehicle testing use (optional)
- ▶ Dynamic range 100dB
- ▶ Supports multiple tach inputs
- ▶ Multi-input, multi-output (MIMO)

- Compact 16-channel unit suitable for in-vehicle use
- Extensible to up to 64 channels by simultaneously connecting units
- User-friendly GUI
- Compatibility with WCAmini and WCAonPC
- Can be used either as a single unit or by connecting multiple units

In-vehicle test



Kit for in-vehicle use is available as an option



Example of 16-channel configuration



- Use of all WCAPRO features is possible, such as in-vehicle tracking measurement
- Easy one-touch operation in the vehicle cabin with a customized screen using COM interface

Test with multiple channel simultaneous measurement



Example of 64-channel configuration



Simultaneous measurement is possible with dedicated synchronous signals by connecting the unit and PC through the hub by LAN cable

Multi-Analysis Software

WCAPRO

WCAPRO multi-analysis software delivers an easy to handle user interface as a Windows application. By connecting to the front end CompactWCA and WCAmini, WCAPRO can support noise and vibration test analysis as a realtime FFT analyzer.

Also, by adding the relevant optional functions, it is possible to perform realtime octave analysis, tracking analysis and filtering function in an integrated manner.

With the throughput function, it is possible to perform time series data recording (standard) over a long period of time as well as repeated playback analysis. Offline post-processing analysis with a standalone PC is also possible (optional).

WCAPRO supports COM interface.

WCAPRO can be controlled and the screen easily customized using VB, VBA, etc.

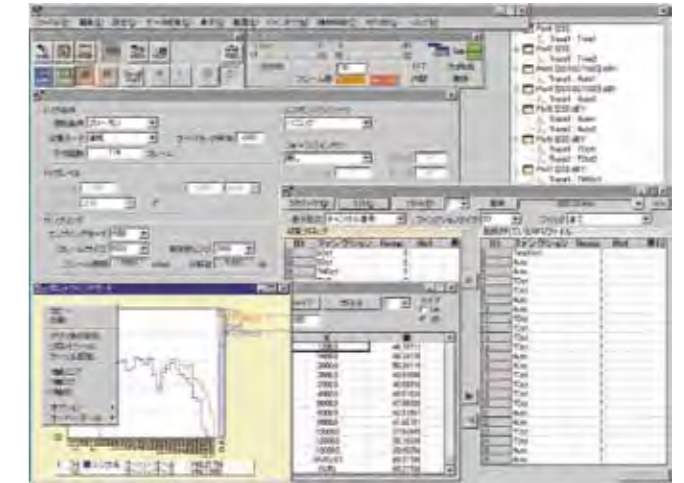

User Interface

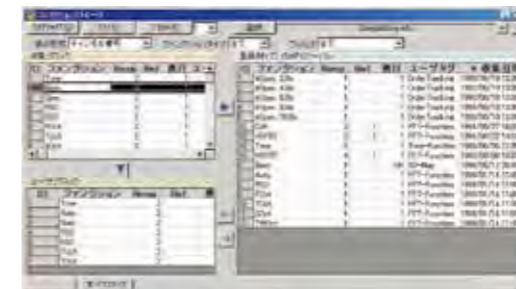

Data control window

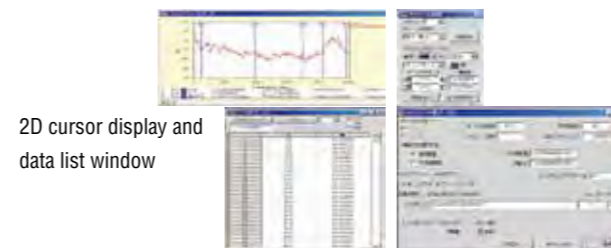

2D cursor display and data list window



3D data post-processing window

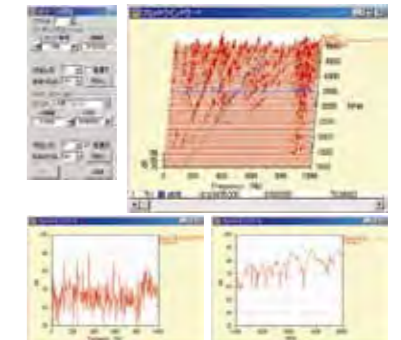

3D cursor display and 2D data cut-out window

Realtime FFT Analyzer



CompactWCA AD3651



WCAmini AD3661

Multi-Analysis Software

WCAPRO

Optional Functions

Realtime octave analysis

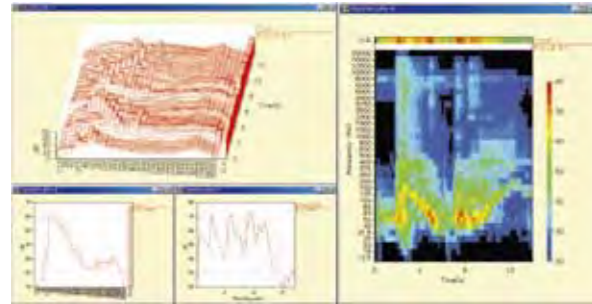

Tracking analysis

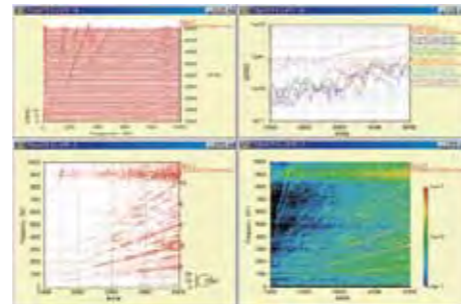

Filtering function

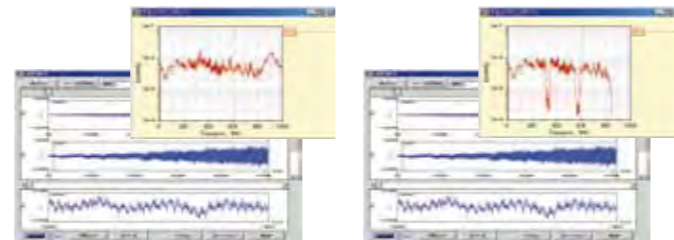
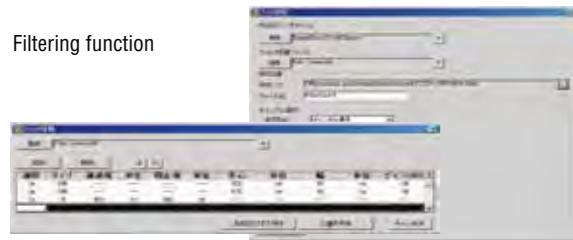

Throughput Function

The window below shows time series data in total wave form display and enlarged display. Confirmation of data covering a long period of time, designation of the analysis range, sound playback and designated range can all be exported to a separate file. Further, it is possible to convert time series data to CSV files, WAV files or MAT files (Level 4); or read a CSV file as time series data

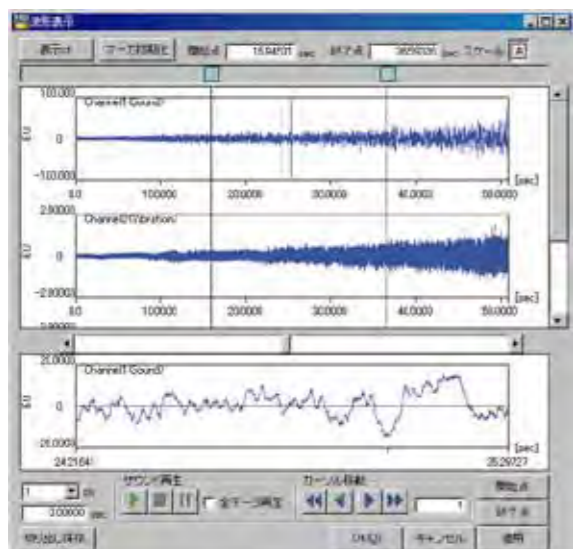

Screen Customization

The customized window below is an example of returning to a fixed condition file and repeating collection. It is possible to perform FFT analysis or tracking analysis with only 6 buttons. A free COM sample is provided

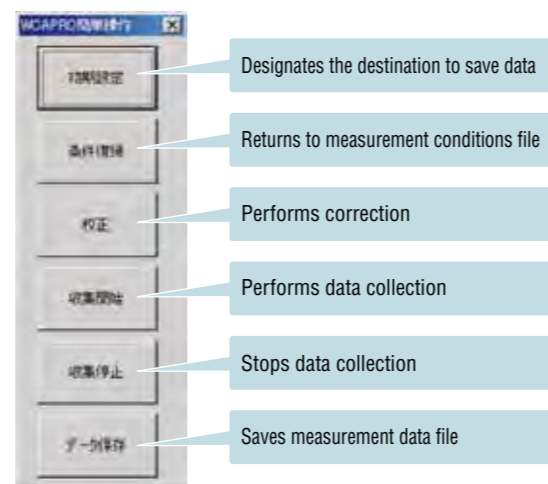

Offline Post-Processing Analysis Software

WCAPRO

When WCAPRO is not connected in the front end it can be used for offline post-processing analysis (optional). For a long period of time series data or an analysis data file, WCAPRO's functions can be used on a file.



Process to Data Analysis

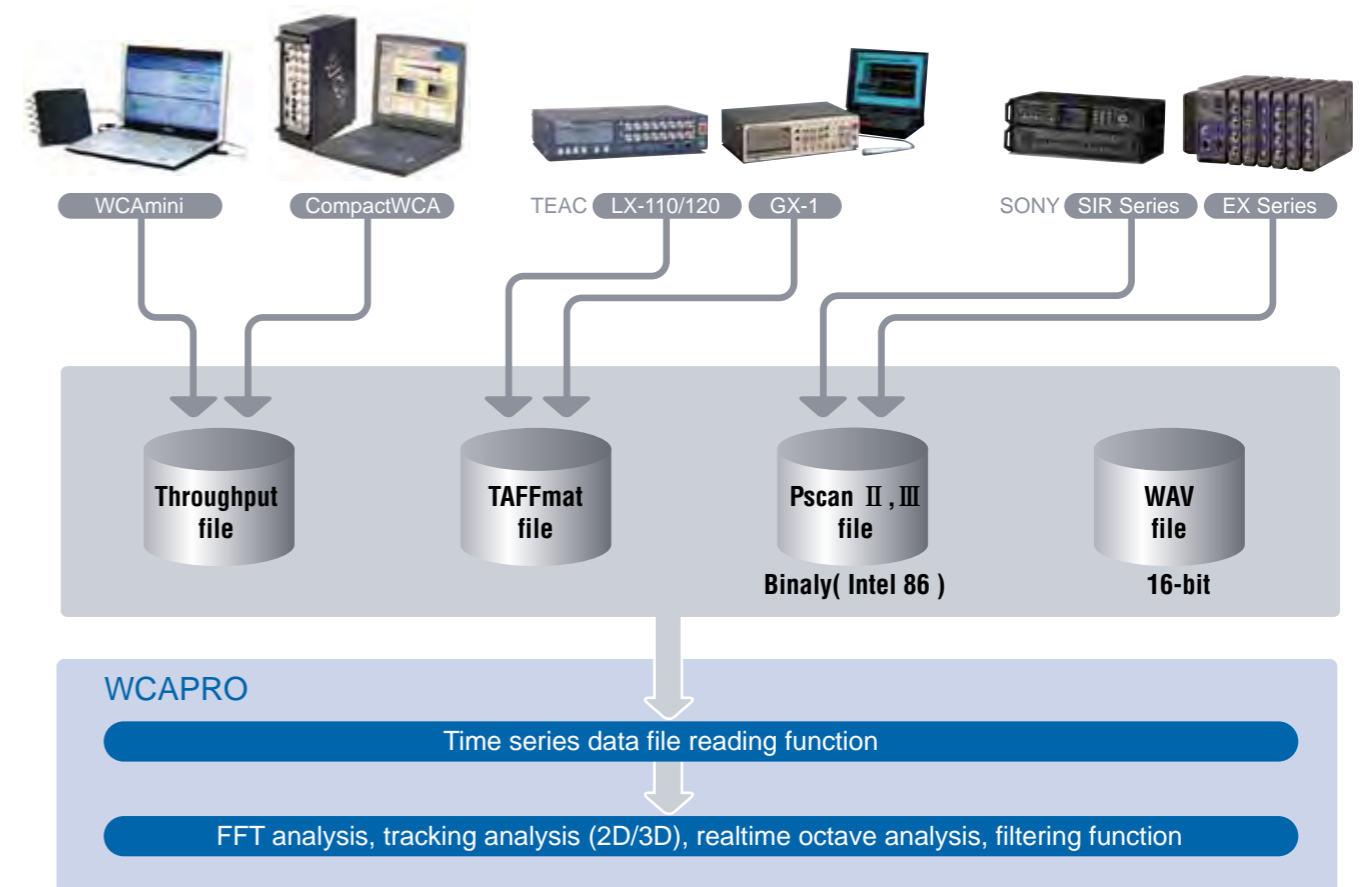

Measurement Analysis Device for Multiple Channel Vibration Testing

Simple operation of multiple channel data measurement, analysis, graph printout and CSV file saving

Vibration Testing

- **Random test**
FFT analysis (time waveform, effective value, spectrum, power spectrum, PSD, cross spectrum, transfer function, coherence, autocorrelation, cross correlation)
- **Sine wave test**
Analysis of responsiveness to frequency of sine wave sweep test
- **Shock test**
Using shock response spectrum (SRS) analysis, evaluation of the damage potential from shock excitation experienced by the test specimen

Main Features

- Maximum 192ch charge amplifier and AD input (including anti-aliasing filter)
 - Continuous collection to 5120Hz sampling (maximum 15 minutes)
 - Simultaneous sampling up to 40960Hz (192ch x 40960Hz collection buffer capacity: maximum 10 seconds)
 - Maximum 16ch wave form monitor function (time wave form, spectrum, PSD, transfer function, coherence, etc)
 - Data saving format is WCAPRO throughput file
- * Vibration testing device, control not included

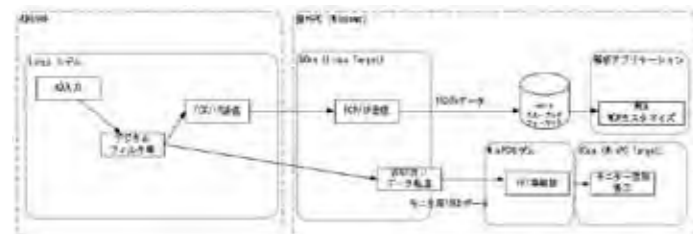
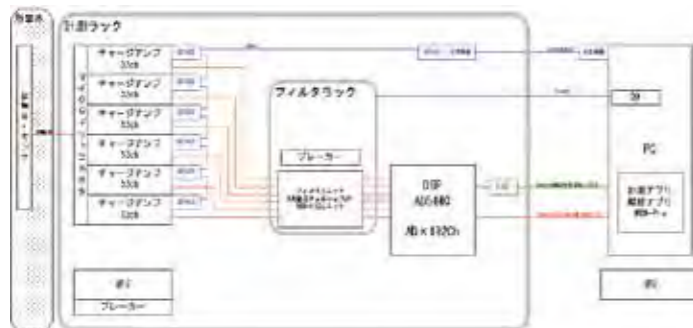

Engine Bench Integrated Measurement System

Improvement of the engine test bench measurement environment

With a system with the AD5440 at its base, various signals that differ from the sampling speed, such as revolutions, torque and angle, have measurement control, data monitoring, collection, saving and analysis performed. With the analysis application, user names, specification data, etc. will be subject to improved uniform management and work efficiency in the database.

The system provides a wide range of analysis functions such as crank angle graphs, tracking graphs, filtering function, arithmetic processing, FFT analysis and order tracking. It is also possible to export data to Excel. Using the RTS torque sensor it is possible to perform high precision torque wave measurement.

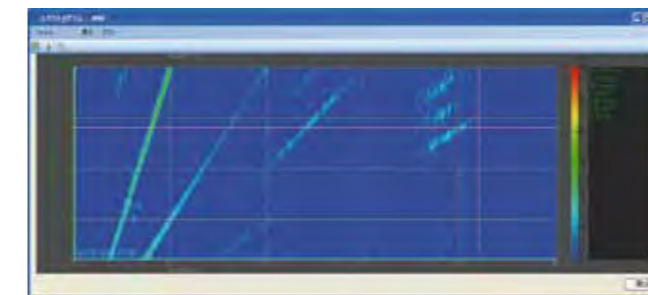

Color map

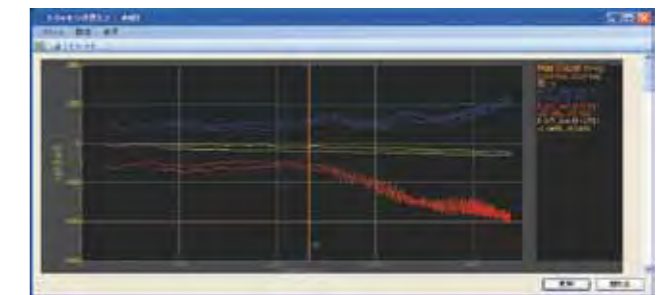

Tracking graph

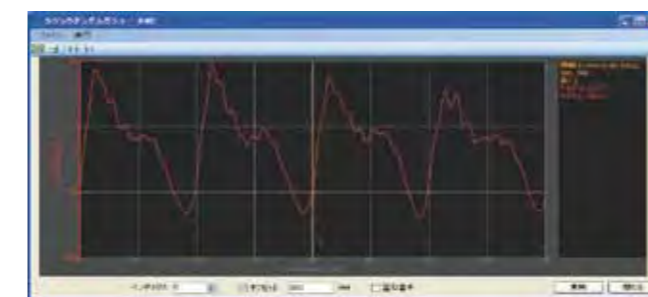

Crank angle and torque graph



RTS torque sensor



Example of attachment of dynamo intermediate axis



Filtering function



Mathematical calculation

Measurement System

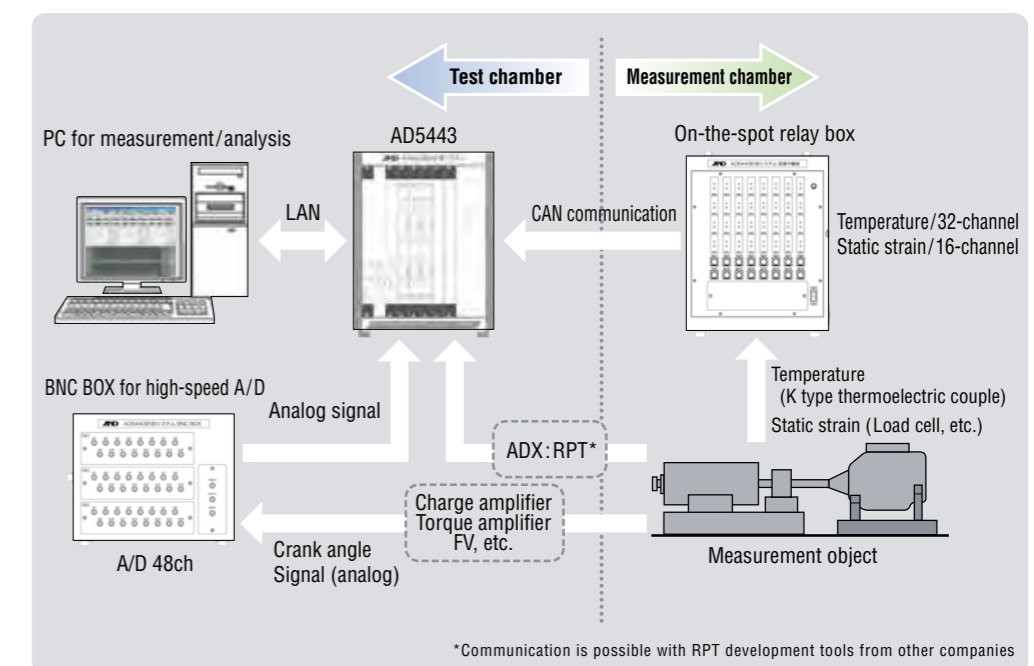

Introducing the Applications

FFT Analysis

On top of frequency analysis of noise or vibration, etc., FFT analysis can be used widely for many other purposes. An acronym standing for Fast Fourier Transform, FFT is an algorithm which can calculate at high speed which frequency components are found to what degree inside signals.

As each frequency component found by FFT has a narrow frequency range they are expressed as line spectrums and FFT analysis is also referred to as narrow band analysis. It is very useful for figuring out the frequency components of vibrations or noise, etc. For noise analysis, as it has a high correlation with humans' auditory perception, the 1/3 octave band is used a lot. As it is used to calculate the octave band from the spectrum found by FFT, it is also called the FFT formula octave.

Vibration measurement example for motor, pump

Acceleration sensor, FFT analyzer
(WCA or CompactWCA)

CompactWCA

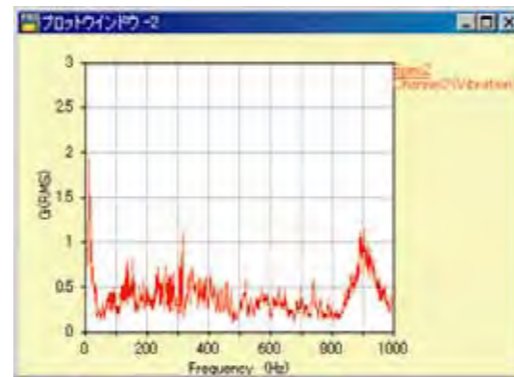

Noise measurement example for transmission

Microphone, FFT analyzer
(WCA or CompactWCA)

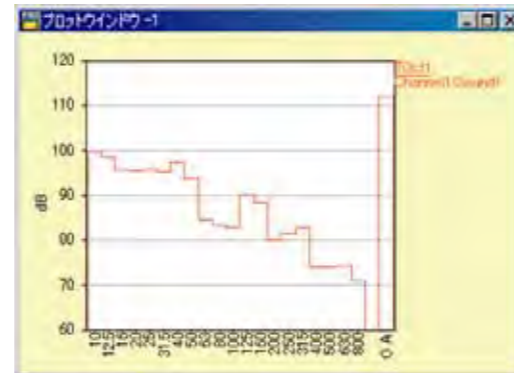

Automatic Defect Detection Using FFT Analysis on a Bearing Inspection Line

The value of a bearing is determined by how smoothly they rotate while in use. If they have flaws inside, when they rotate vibration will occur. The relationship between the location of the flaw (on the inner ring, outer ring or rolling balls) and the vibration frequency that

occurs is quite clear, so with analysis of the vibration frequency with the AD3552, automatic determination of whether a bearing is flawed or not is possible.

Acceleration sensor
Inner ring
Rolling balls
AD3552
Judgment output

$$\text{INNER} = \frac{z \cdot N/60}{2} \left(1 + \frac{d}{D} \cos \alpha \right)$$

N: Inner ring frequency
d: Rolling ball diameter

$$\text{OUTER} = \frac{z \cdot N/60}{2} \left(1 - \frac{d}{D} \cos \alpha \right)$$

Z: Rolling ball frequency
D: Pitch circle diameter of the axle bearing

$$\text{BALL} = \frac{D \cdot N/60}{d} \left(1 - \frac{d^2}{D^2} \cos^2 \alpha \right)$$

α : Angle of contact
n: 1, 2, 3, 4...

Judgment example

OK (quality product) NG (defect)

Block comparator Judgment results 1-5
Block comparator Judgment results 6-10
Block comparator Judgment results 11-15
Block comparator Judgment results 16-20
Shape comparator Judgment results
Total overall Comparator judgment results
AND-OR
AND-OR
AND-OR
AND-OR
AND-OR
Total judgment results

[Digital input/output communication]
Input: data collection start/finish, data saving, etc.
Output: individual judgment results, total judgment results, etc.

[Serial (RS232C) communication]
Input: data collection start/finish, data saving, etc.
Output: individual judgment results, total judgment results, etc.

LAN terminal Signal input DI/DO
Power terminal Serial External trigger input

Introducing the Applications

Transfer Function Measurement and Test Modal Analysis by Impulse Excitation Technique

As a comparatively simple system configuration and an easily performed test modal analysis method, measurement can be made of the excitation signal created when the test object is given excitation force from an impulse hammer, as well as the response signal. The response signal is measured by the force sensor at the

tip of the impulse hammer and the acceleration sensor, etc. By importing these signals to the FFT analyzer, the transfer function which expresses the response characteristics of each frequency of the structural object can be sought.

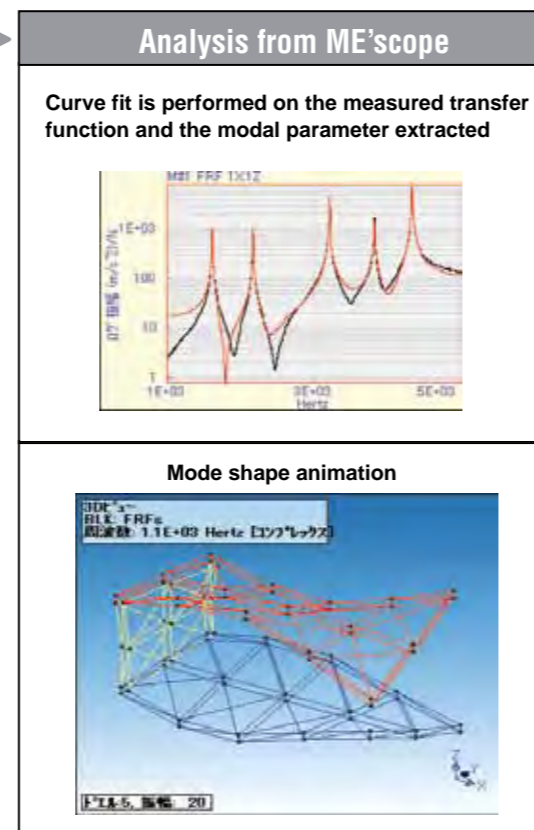
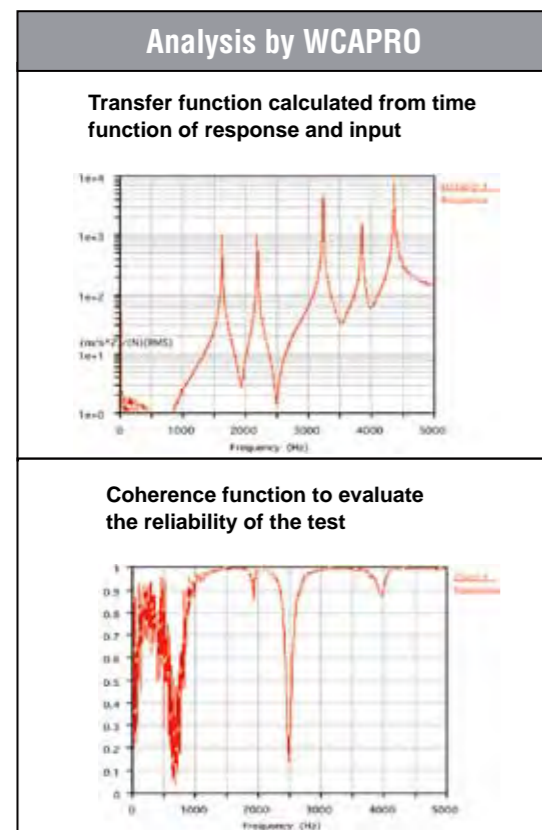
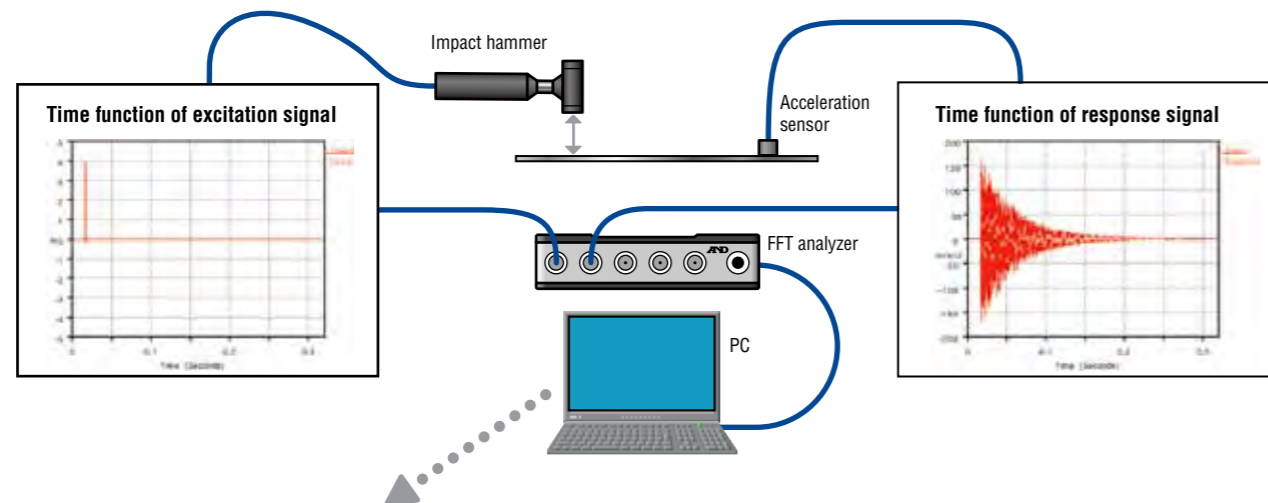

Tracking Analysis

To understand the relationship between the characteristics and the unique vibration frequency of the degree component of the rotary machine, tracking analysis is an effective tool. Rotating bodies such as engines or motors, etc. have rotational components that change frequency when they differ from the unique vibration and the rotation speed changes. The phenomenon that occurs for the first time on the first revolution is defined as the 1st degree revolution, the phenomenon that occurs on the nth time is

defined as the nth degree revolution, and the rotational component is referred to as the degree component. On the horizontal axis: The degree spectrum turns the rotation speed into degrees and mimics it. Tracking analysis is searching for the change in level for each component of this degree spectrum. It is very valuable to understand the relationship between the degree component of the rotating body and the unique vibration frequency and figure out the resonance point of the degree component.



[Example of processing the degree component in realtime]

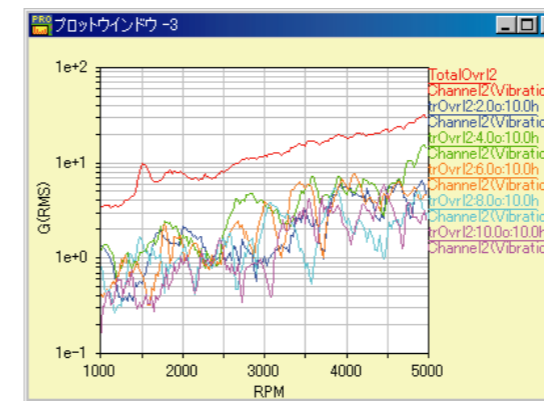

[Measurement connection example]

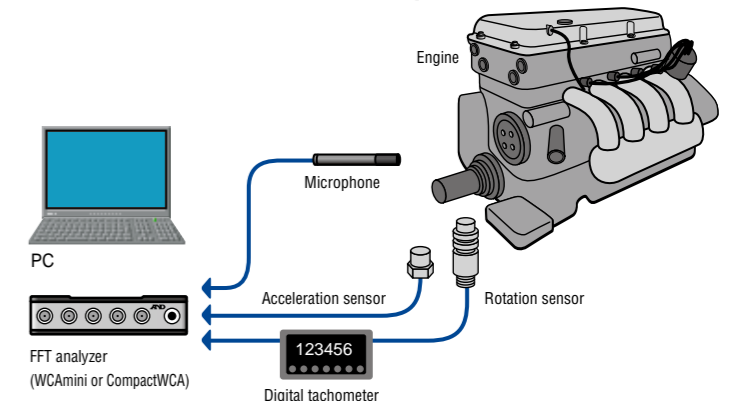

[Example of confirmation of rotational component and resonance frequency captured in a 3D spectrum]

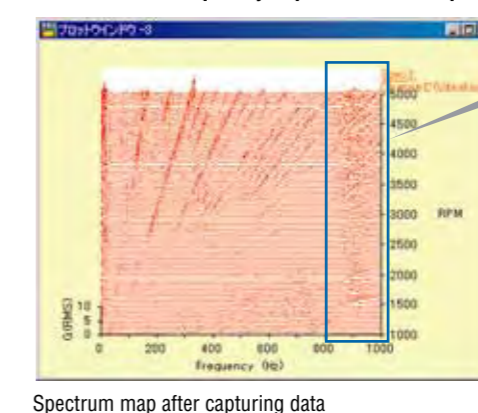
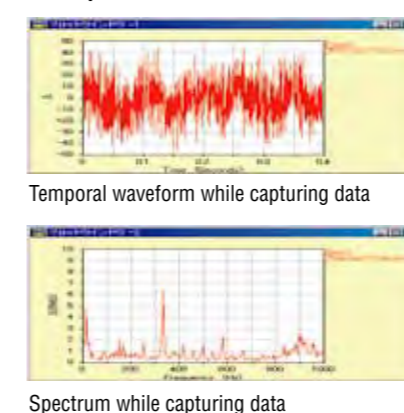

Introducing the Applications

Tracking Analysis

Example of cutting out degree component with 3D cursor

Spectrum map and 3D cursor

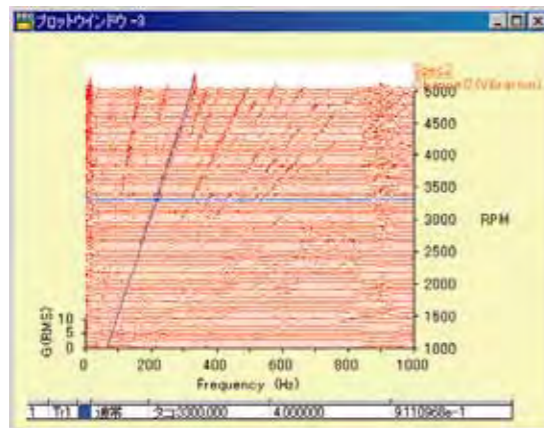

Diagrammatic tracking diagram of cutting out with 3D cursor

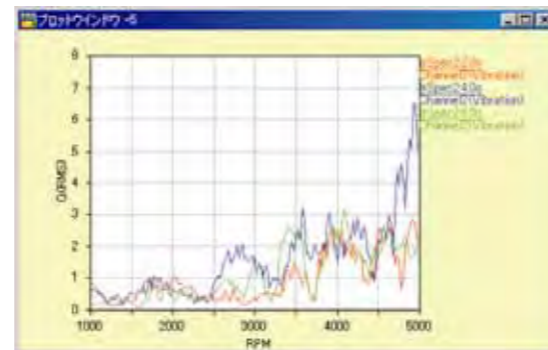

Realtime Octave Analysis

Realtime octave is a method for calculating the octave band by applying a digital filter to time series data on the time axis. In order to distinguish it from the octave of the FFT method calculating the octave band from the spectrum found by FFT, it is also called the digital filter octave.

The octave of the FFT method which seeks the number of octave bands differs in the frame size for processing FFT and in order to search for lower bands it is necessary to make the frame size larger. If the frame size is made bigger, as the time taken to measure one frame grows longer, it is unsuitable for analysis of sound which varies from moment to moment.

The octave of FFT method is suitable for analysis of a steady sound. Digital filter octave does not perform FFT processing, but as it is processing by applying a digital filter to the time axis it is possible to see how excessive noise is changing over the lapse of time. Also, it is always possible to search for both higher and lower bands.

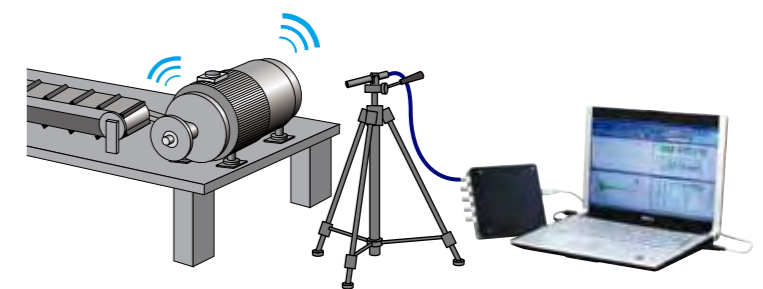

Example of 3D data display

Spectrum map

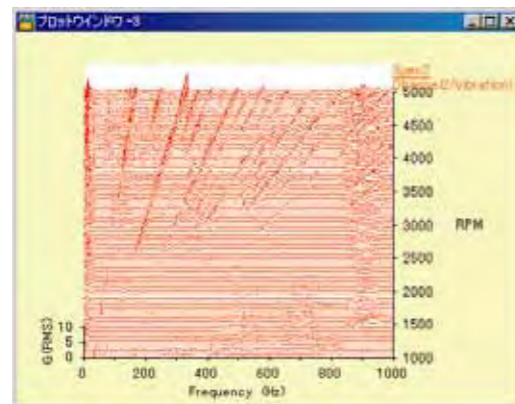

Campbell diagram

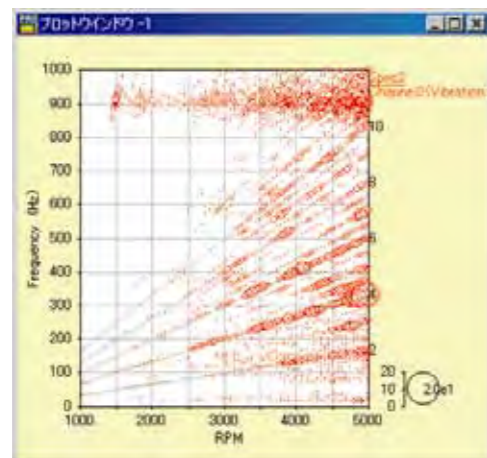

Spectrum

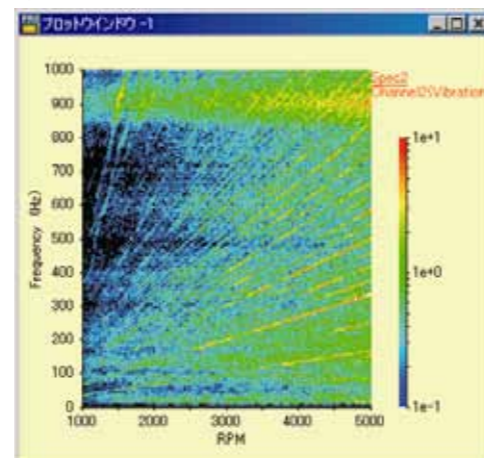

Analysis of transmitted acceleration exhaust sound

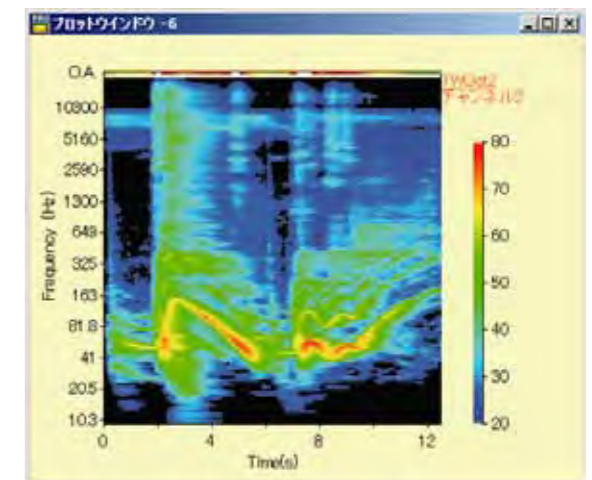

Analysis of excess data

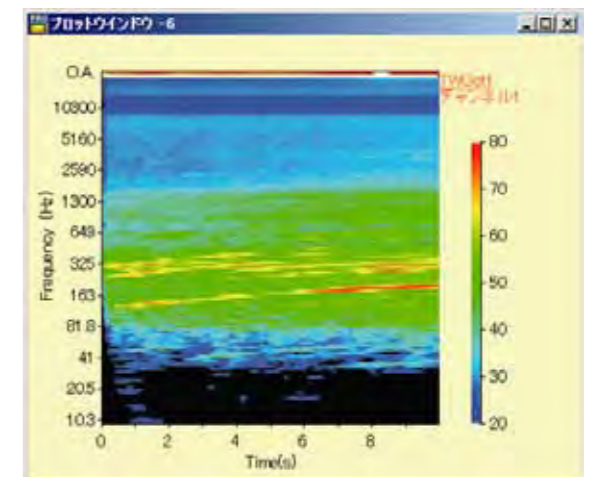

Introducing the Applications

Vibration Analysis using Throughput Function

Uses a playback analysis function by directly recording time series data onto the hard disc of the computer, and measurement and analysis of shock waves can easily be performed.

While it is also possible to measure using the trigger function, when the timing of shock wave generation is more or less understood it is

possible to record time series data from a few moments prior and easily analyze only the necessary data which has been confirmed as waveform. As it is also not necessary to set the trigger, operation is easy with no preliminary measurement needed and analysis possible in a short period of time.

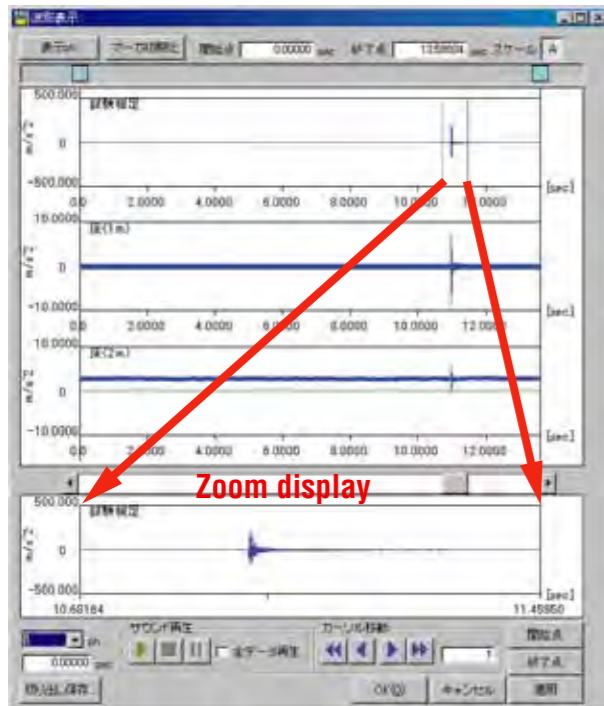

Enlarged shock wave display and total waveform display from recorded time series data

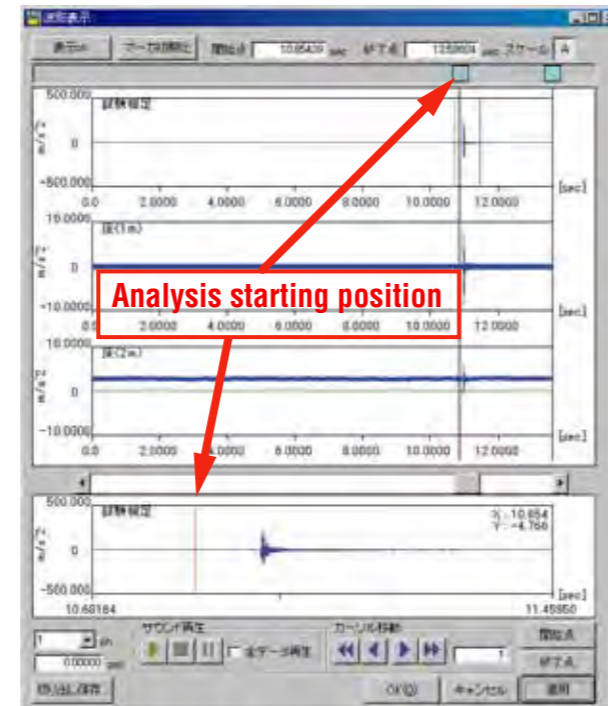

Designating the analysis starting time on the enlarged shock wave display screen

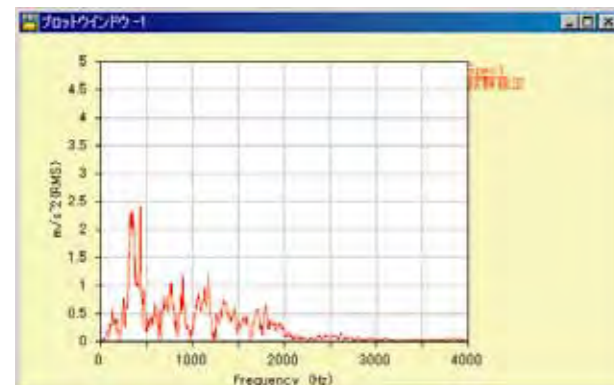

Spectrum of shock wave

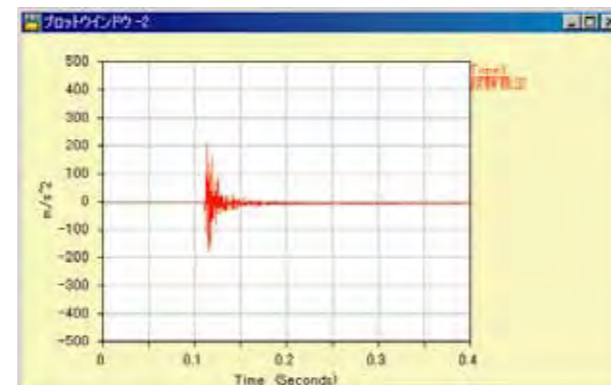

Temporal waveform of shock wave

Experiment Analysis of Vibration/Acoustic Phenomena of Machines/Structural Objects

With data measurement by CompactWCA and WCAmini, and analytical processing by ME'scopeVES, the vibration/acoustic phenomena of machines and structural objects can be easily analyzed.

*ME'scope is a product of Vibrant Technology, Inc. (A&D provides retail and support)

Real Operation Analysis

Based on the data measured by CompactWCA and WCAmini, it is possible to create a visual animation of the real operation conditions of structural object or walls. Time, frequency and order animations are used to comprehend these real operation conditions. Real operation analysis is only the measurement and analysis of the response of the real operation conditions of the test object.

The method of imparting excitation force on the test object and measuring its response is used a lot for difficult cases, but as it is possible to easily figure out the deformation pattern (bending, twisting, etc.) of the test object it will produce an effect as a basic tool for someone just starting experimental modal analysis.

Time Animation

Possible to animate the deformation pattern with time history data of the real operation conditions of machines or structural objects

Frequency Animation

Possible to animate the deformation pattern for specific frequencies by frequency domain data of the real operation conditions of machines or structural objects

Order Animation

If the machine or structural object is a rotating body, it is possible to animate the deformation patterns of each degree component for rotational change

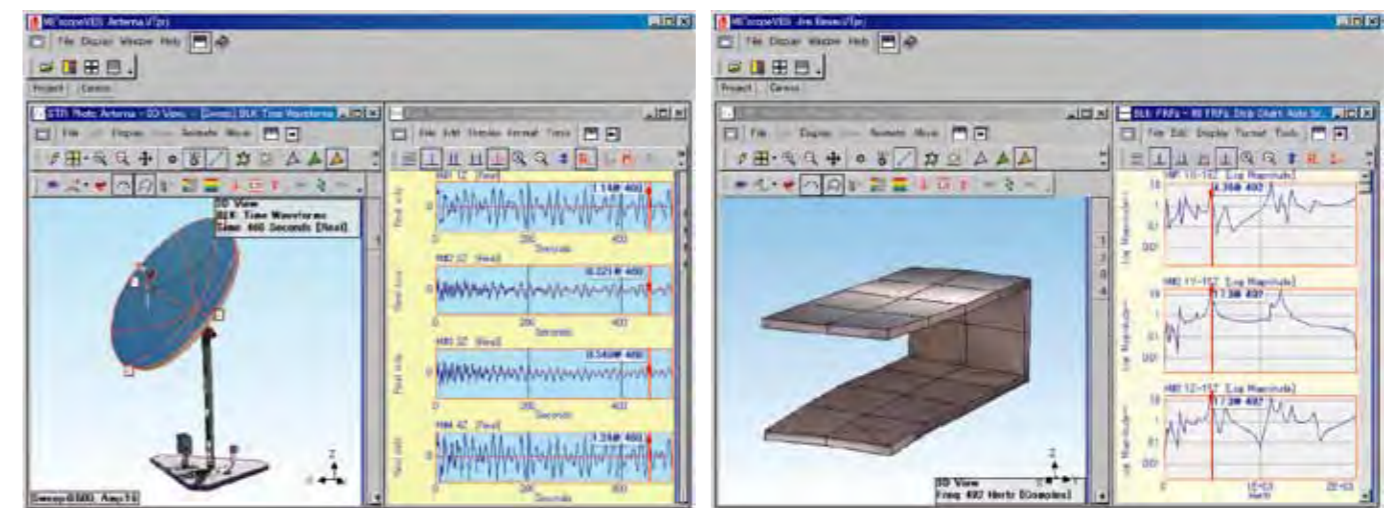

Introducing the Applications

Experimental Modal Analysis

Based on data measured by CompactWCA and WCAmini, it is possible to identify the unique vibration frequencies of structural objects (mode frequencies), damping ratios and mode shapes. With experimental modal analysis, from imparting excitation force on the test object, measuring the response, and using the transfer

function data from that response, the dynamic characteristics (unique vibration frequencies, damping ratios and mode shapes) of machines and structural objects can be sought. From mode shape, the differences in deformation patterns (bending, screwing, etc.) in each unique vibration frequency can be figured out.

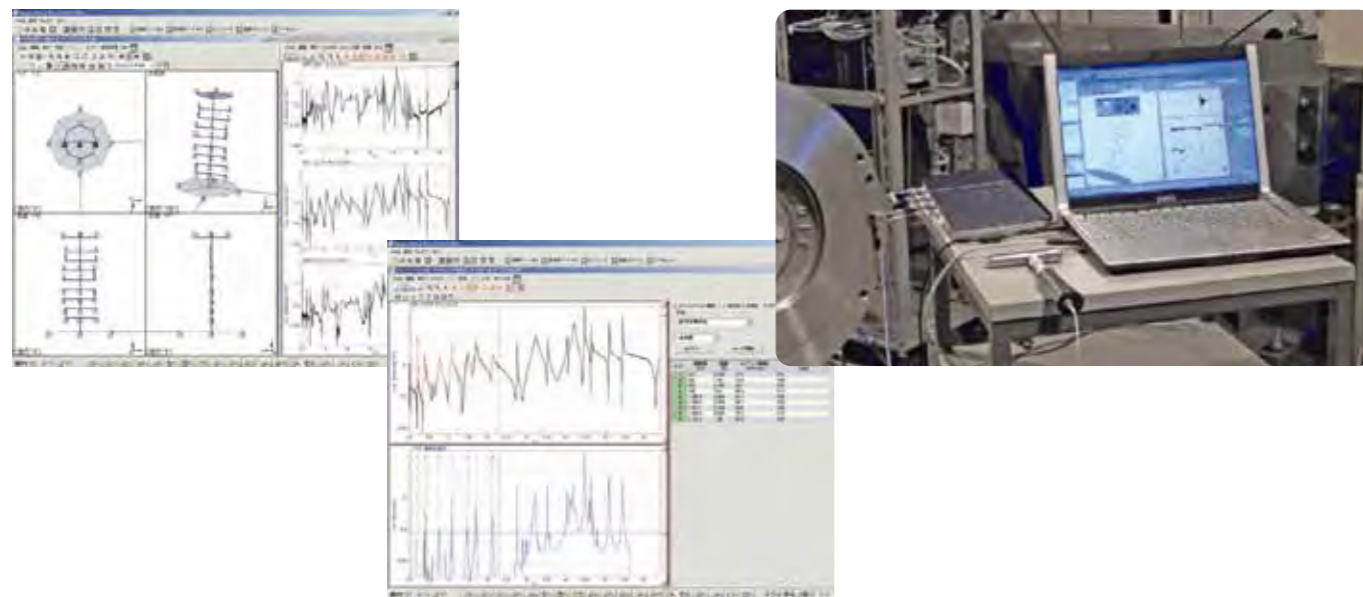

Sound Analysis

Based on data measured by CompactWCA and WCAmini, sound intensity, sound pressure level (SPL) and sound power are sought and it is possible to effectively display the relationship between the vibration of the surfaces of machines or structural objects and sound data. Further, with the creation of an animation displaying vibration and sound data together, vibration and sound issues can be tested.

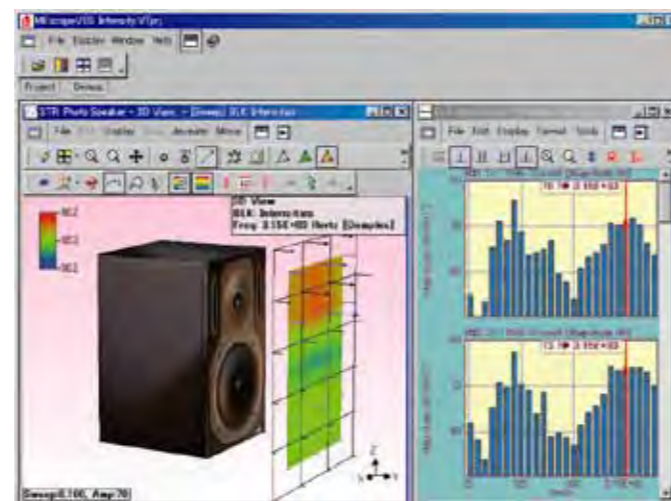

Stress Tracking

Stress tracking can be performed using CompactWCA or WCAmini's tracking analysis functions. Maximum stress and minimum stress synchronized to the number of revolutions are measured and intensity towards the parts of the rotary machine can be confirmed. From the maximum and minimum stresses the average and difference is sought and on the horizontal axis the stress tracking lines for the revolutions are drawn.

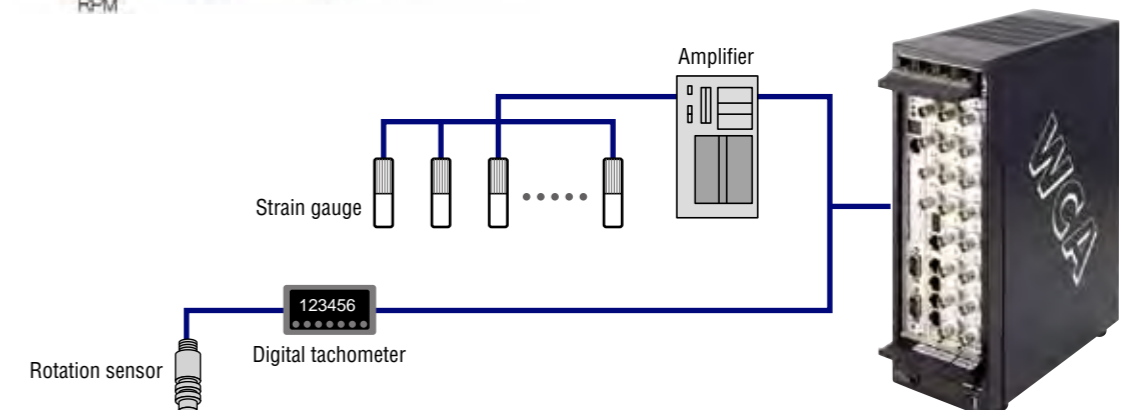
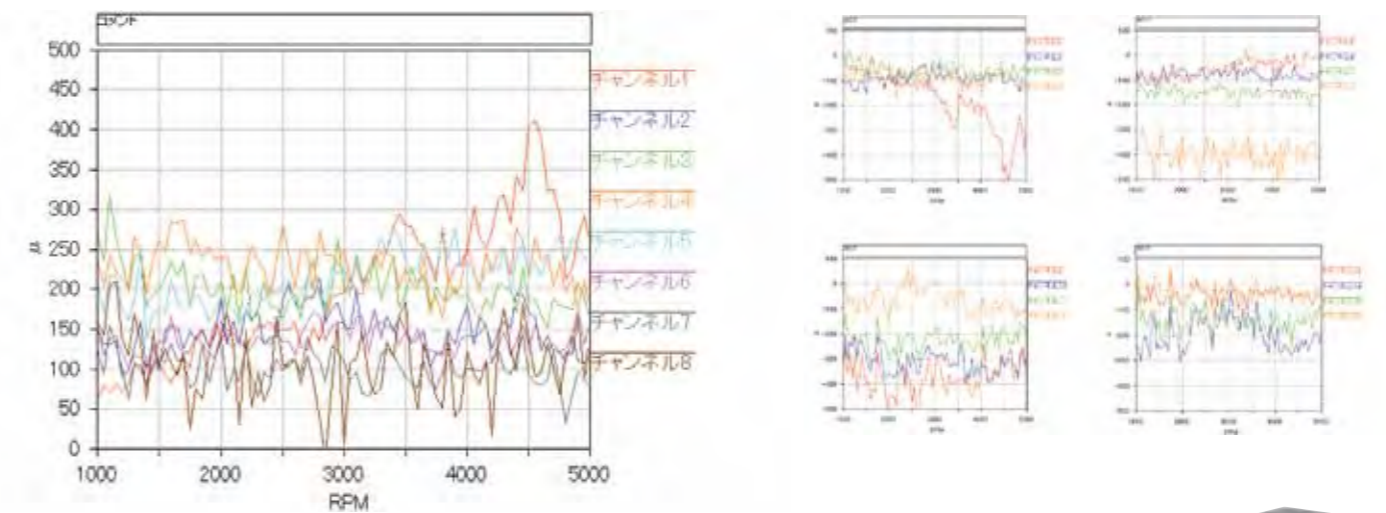
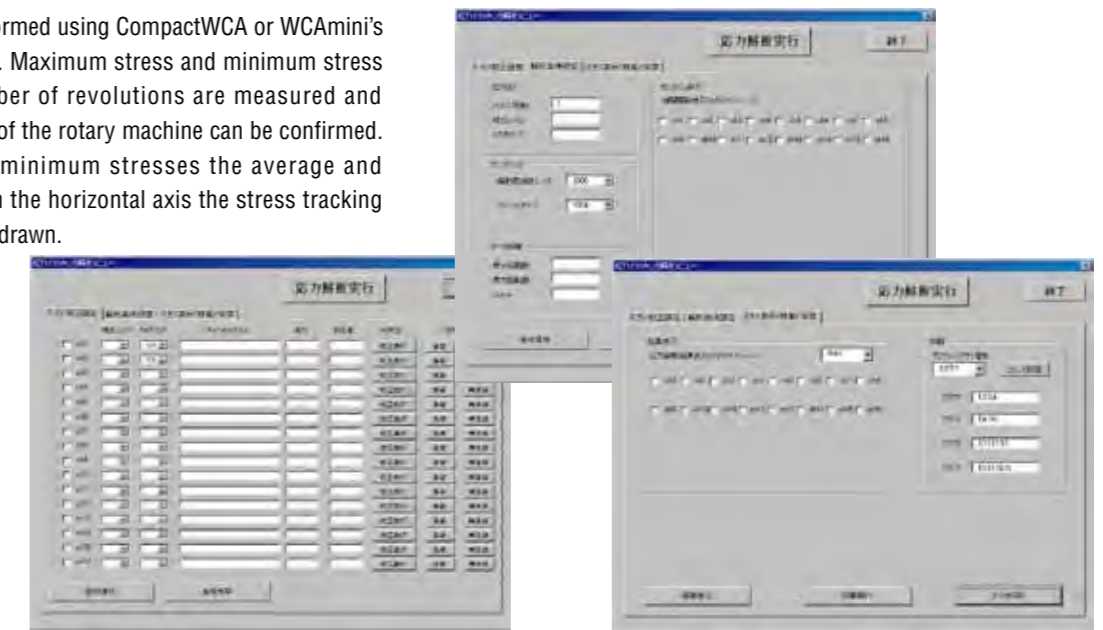

Introducing the Applications

Sound Power Level Measurement

Sound power level measurement can be performed using CompactWCA or WCAmini's realtime octave analysis. Sound power level can be obtained from the sound pressure level recorded by 10 microphones set up on the measurement side of the object.

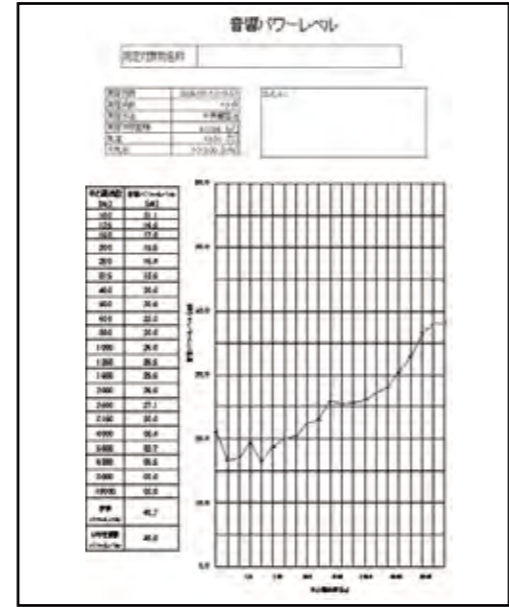
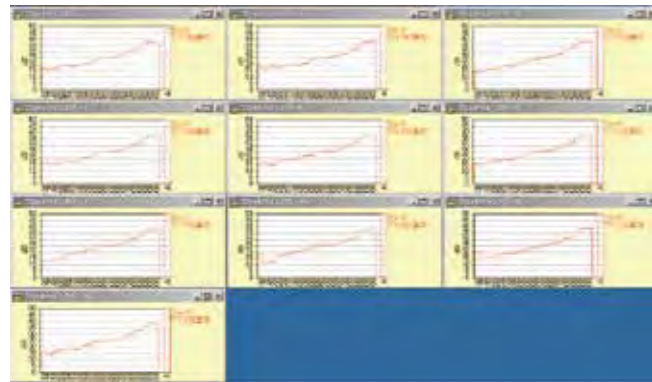
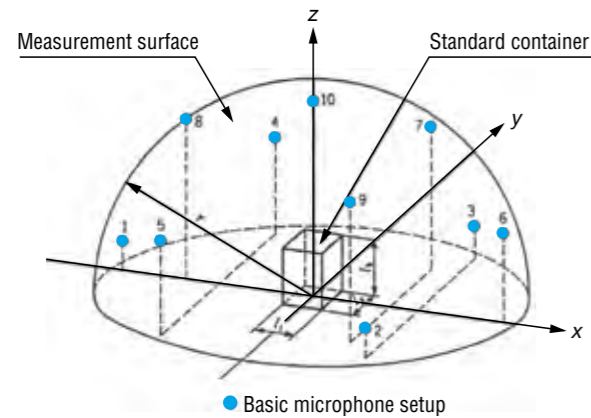

Connection example

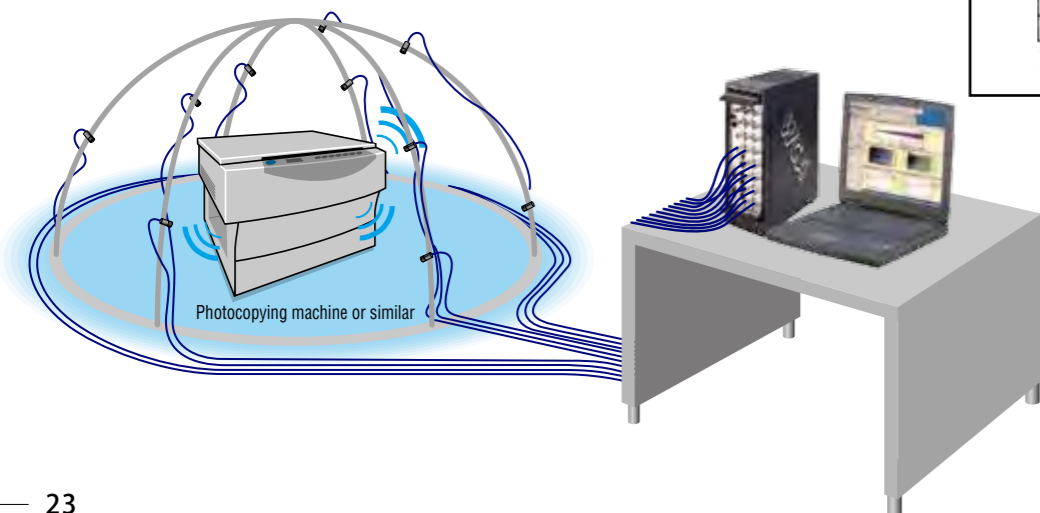

Field Balance

Field balance is determined by using the tracking analysis function of CompactWCA or WCAmini. The size of the unbalance of the rotating body is measured, and using the test weight it is possible to

define the attributes of the unbalance (location, mass) and reduce its size. Either a one-sided or two-sided balance can be corrected at just one speed.

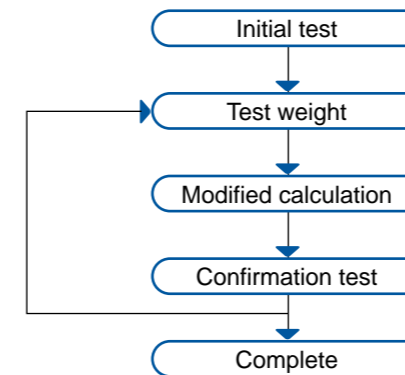
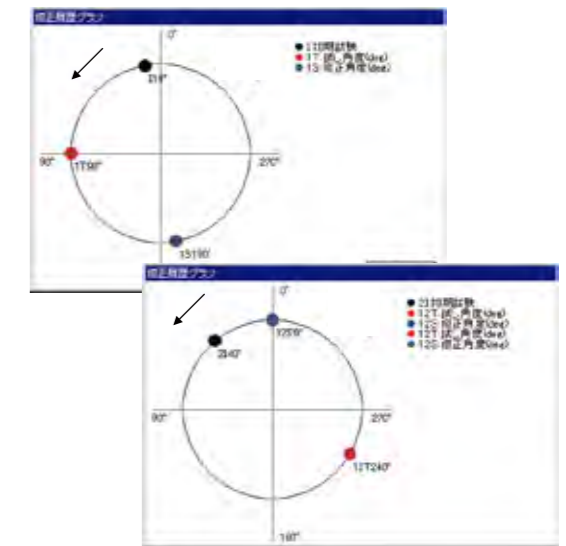
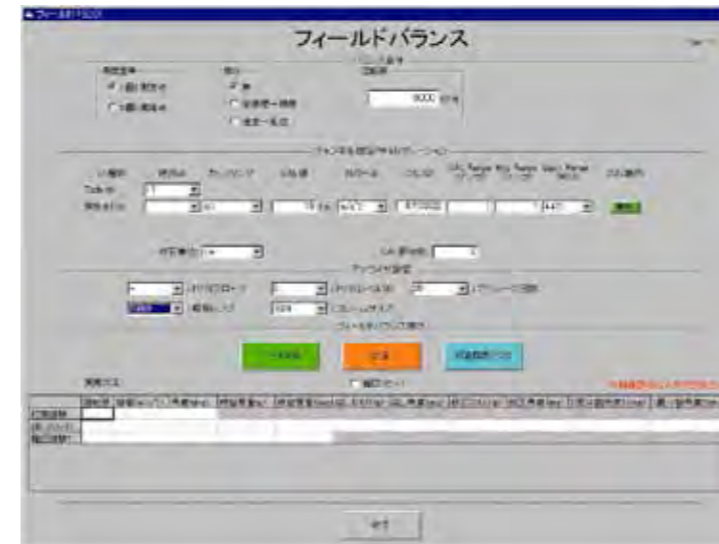

[Processing flow for a one-sided balance]

- With measurement by 1 point per 1 side, 1ch measurement channel and 1ch tach input are used.
- (1) Initial test: data is gathered for the condition of the unbalance
 - (2) Test weight: Data collection with the test weight attached
 - (3) Modified calculation: Based on the above result, mass and location of the test weight are calculated
 - (4) Confirmation test: Data collection with the test weight attached

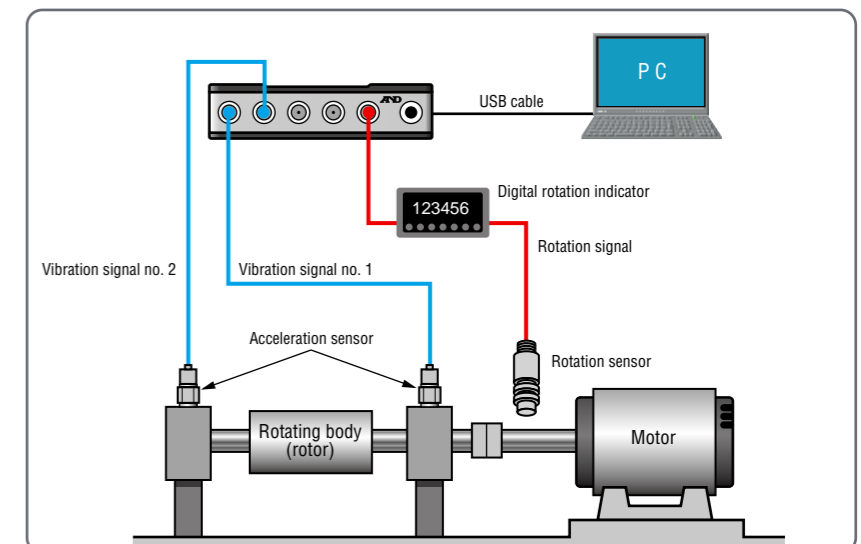

Introducing the Applications

Rotational Fluctuation/Torsional Vibration Analysis

It is possible to analyze the rotational fluctuation component from the rotational signal (time series data) recorded with the throughput function of CompactWCA or WCAmini.

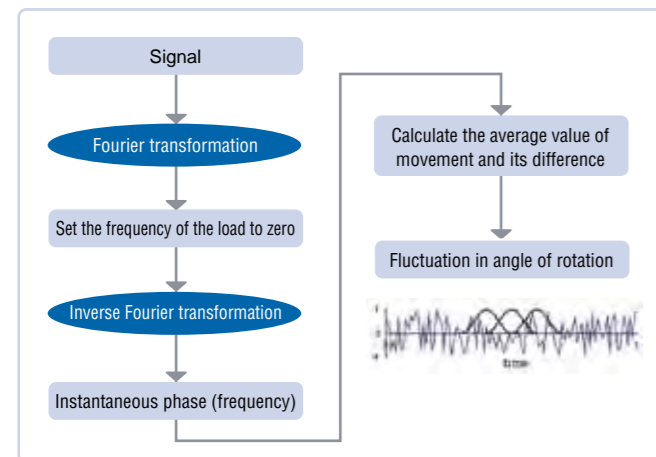

By the instantaneous frequency method using analytical signals, the instantaneous angle of rotation of the rotating body can be sought. The fluctuation in the angle of rotation is found from the instantaneous angle of rotation and the difference from its average value of movement.

The torsional vibration component is found from the difference in the angle of rotation between two points on the rotational axis, e.g. drive side and load side.

By tracking analysis of the torsional vibration component, for the intensity between the two points on the axis, it can be learnt at around which frequency there is a transformation from rigid to soft, etc.

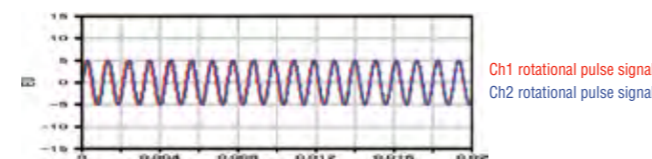

Computation of the angle of rotation using instantaneous frequency

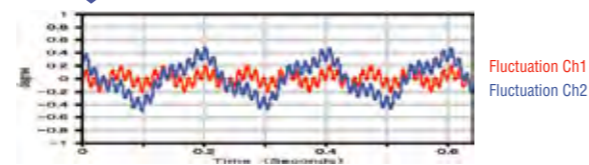

Difference in the angle of rotation between two channels

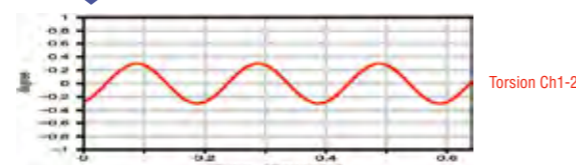

[Example of torsional rotation analysis]

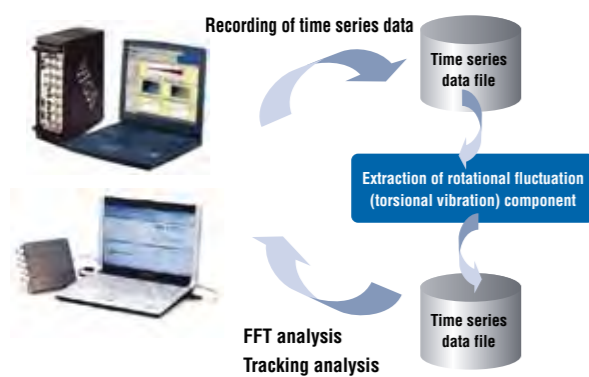

Rotational fluctuation and torsional vibration do not remain the cause of unwanted vibration noise, but can influence the durability of the rotating machinery, and sometimes could lead to damage of the system. It is very important to determine the resonance point of the degree component and unique frequency of the axis.

Intended usage : rotational fluctuation analysis of ship engines
Torsional vibration analysis of the crankshaft of car engines

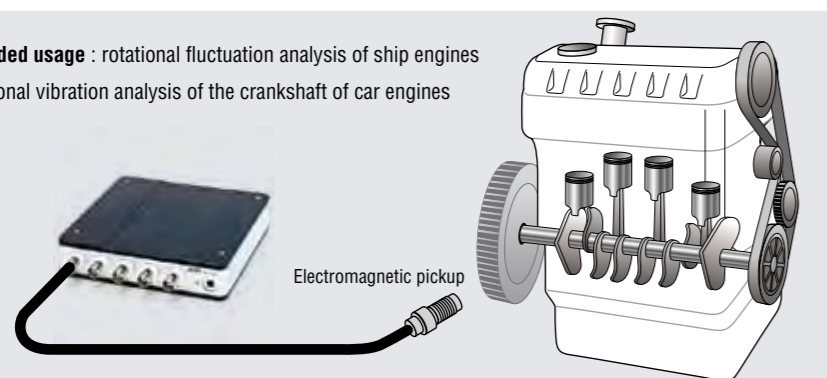

Customization based on years of experience

CompactWCA and WCAmini can be used to customize a user original vibration noise analysis system

- WCAPRO can be freely controlled with COM interface
- An original system is presented, applying 27 years of history of the FFT analyzer and an abundance of support experience

Vibration Noise Total Analysis System An operation system is realized with user control of FFT analysis, hammering analysis, octave band analysis and further original analysis by the user

Example of Customization

- | | |
|---------------------------------|---------------------------------|
| ① Channel settings | ⑥ Measurement data confirmation |
| ② Calibration | ⑦ Data saved |
| ③ Collection condition settings | ⑧ Post-processing |
| ④ Analysis condition settings | ⑨ Graph display/printing |
| ⑤ Data collection | ⑩ Data management |



Main menu



FFT analysis menu

Screen during measurement

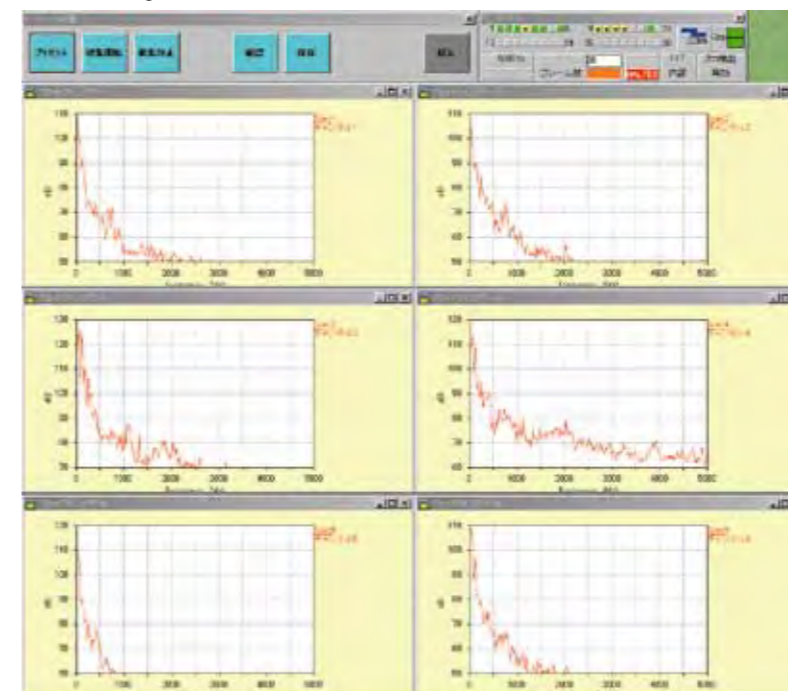

Settings are for necessary functions only, other settings are automatically set on the customized application for improved work efficiency.

With the same operation system used for different types of analysis a manual is no longer needed.

Introducing the Applications

Customization based on years of experience

Testing System with Durable Operational Performance

Vibration, unwanted noise, temperature, load data, etc. can be measured over a long duration and performance tests performed. As abnormal values trigger an alarm and stop the testing device, it is possible to keep any damage to the device to a minimum.

ch	信号種類	測定値	単位
1	荷重	*****	dB
2	振動	*****	dB
3	応力	*****	MPa
4	温度	*****	°C
5	回転速度	*****	rpm

アラーム解除

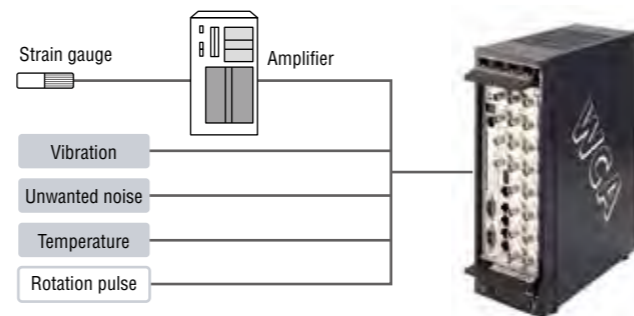
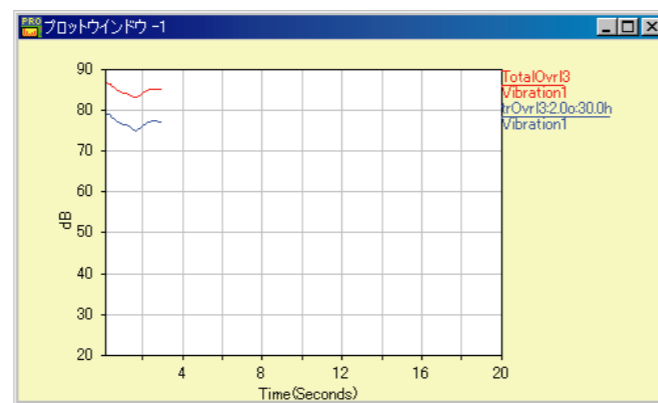

By performing consecutive sound and vibration analysis when testing the durability of an engine's transmission or brakes, etc., it can be applied as abnormal or evaluative back data. Together with a safer testing environment, it can be of great help for endurance testing.

Performance Testing System

It is possible to automatically repeat tracking analysis on the operation pattern of transmission benches, etc., and conduct performance tests.

- Possible to perform tracking analysis on vibrations and unwanted noise together, and make judgments according to standard values
- Possible to gather data for a spectrum map, and perform degree processing by post-processing
- Degree spectrum analysis possible at steady rotation time
- Extraction of peak value at each designated section and statistical processing possible
- Possible to save analysis data and output as text
- Possible to redisplay saved and overwritten data
- Possible to print graph display (individual or collated)

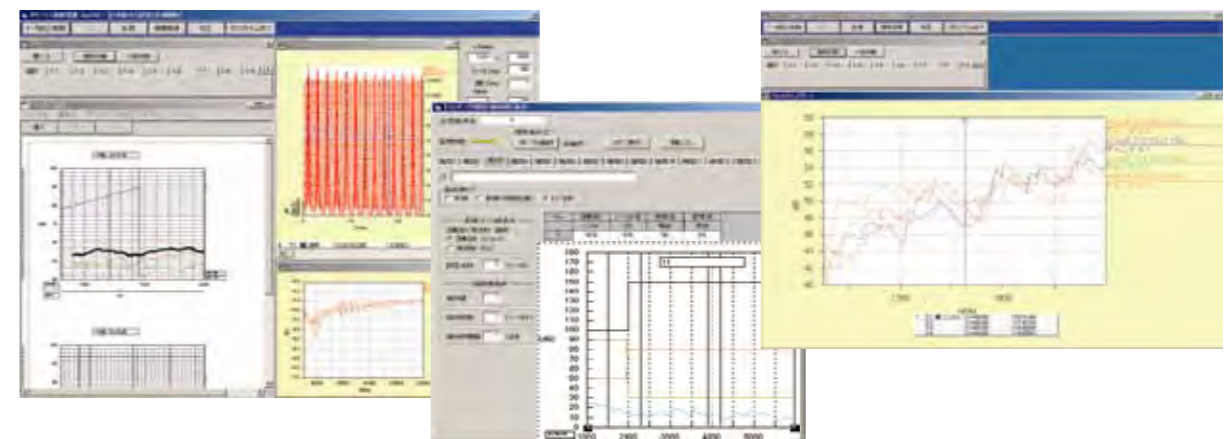

CompactWCA

Please try formulating your own personalized vibration and sound analysis system. Office-wide operating procedures or configurations can be refined and with data management the efficiency of test results can be improved. For repeatable tests, by pre-defining measurement patterns automatic measurement can be realized. A&D's customization skills garnered through years of experience can be of use to any customer.

Transmission method
DIO, Ethernet, Serial, etc

